



User Guide

Avanti JXN Series

High Performance Centrifuges



PN B38323AG
January 2021



Beckman Coulter, Inc.
250 S. Kraemer Blvd.
Brea, CA 92821 U.S.A.



Avanti JXN
High Performance Centrifuges User Guide
PN B38323AG (January 2021)

© 2021 Beckman Coulter, Inc.
All Rights Reserved

Beckman Coulter, the stylized logo, and the Beckman Coulter product and service marks mentioned herein are trademarks or registered trademarks of Beckman Coulter, Inc. in the United States and other countries.

All other trademarks are the property of their respective owners.

Contact Us

If you have any questions, contact our Customer Support Center.

- Worldwide, find us via our website at www.beckman.com/support/technical
- In the USA and Canada, call us at 1-800-369-0333.
- Outside of the USA and Canada, contact your local Beckman Coulter Representative.



Beckman Coulter Eurocenter S.A.
22, rue Juste-Olivier
Case Postale 1044
CH - 1260 Nyon 1, Switzerland
Tel: +41 (0) 22 365 36 11

Glossary of Symbols is available at
beckman.com/techdocs (PN C24689).

May be covered by one or more pat. - see
www.beckman.com/patents

Original Instructions

Revision History

Initial Issue, 02/2014

Avanti JXN-26

Avantii JXN-30

Initial Release

Issue AB, 10/2014

Updates were made to the following sections: Table 1.2, Available Rotors- Removed JLA-10.500 entries for JXN-30 Max RPM and JXN-30 Max RCF; Removed JS-5.9 Swinging Bucket Rotor.

Issue AC, 04/2016

Updates were made to the following sections: *Multiple Compliance*.

Issue AD, 09/2018

Updates were made to the following sections: CHAPTER 7, *Accessing the Rotor in Case of Power Failure*.

Issue AE, 03/2019

Updates were made to the following sections: CHAPTER 1, *Avanti JXN Series Specifications*

Issue AF, 07/2019

Updates were made to the following sections: Table 1.2, Available Rotor

Issue AG, 01/2021

Updates were made to the following sections: [RoHS Notice](#), [Software Copyright](#), CHAPTER 1, [Available Rotors](#), CHAPTER 2, [About Page](#), CHAPTER 4, [Overview](#), CHAPTER 4, [Managing Your Network](#), CHAPTER 4, [Setting Up a Network](#), CHAPTER 4, [Managing Reports](#), CHAPTER 4, [Export Data](#), CHAPTER 4, [Enabling Run Comments](#), CHAPTER 4, [Managing Qualifications](#), CHAPTER 6, [System Options Page](#), CHAPTER 6, [Setup Network Page](#), CHAPTER 6, [Setup Network Path](#), CHAPTER 6, [About Page](#), APPENDIX C, [Diagnostics/User Messages Chart](#), Deleted Appendix D, Third Party Contributions and Legal Notices.

Note: *Changes that are part of the most recent revision are indicated in text by a bar in the margin of the amended page.*

For labeling updates, go to www.beckman.com and download the latest version of the manual or system help for your instrument.

Safety Notice

Read all product manuals and consult with Beckman Coulter-trained personnel before attempting to operate instrument. Do not attempt to perform any procedure before carefully reading all instructions. Always follow product labeling and manufacturer's recommendations. If in doubt as to how to proceed in any situation, contact your Beckman Coulter Representative.

Beckman Coulter, Inc. urges its customers and employees to comply with all national health and safety standards such as the use of barrier protection. This may include, but is not limited to, protective eyewear, gloves, and suitable laboratory attire when operating or maintaining this or any other automated laboratory analyzer.

Alerts for Danger, Warning, Caution, Important, and Note

DANGER

DANGER indicates an imminently hazardous situation which, if not avoided, will result in death or serious injury.

WARNING

WARNING indicates a potentially hazardous situation which, if not avoided, could result in death or serious injury. May be used to indicate the possibility of erroneous data that could result in an incorrect diagnosis.

CAUTION

CAUTION indicates a potentially hazardous situation, which, if not avoided, may result in minor or moderate injury. It may also be used to alert against unsafe practices. May be used to indicate the possibility of erroneous data that could result in an incorrect diagnosis.

IMPORTANT IMPORTANT is used for comments that add value to the step or procedure being performed. Following the advice in the Important adds benefit to the performance of a piece of equipment or to a process.

NOTE NOTE is used to call attention to notable information that should be followed during installation, use, or servicing of this equipment.

 **WARNING**

Risk of operator injury if:

- All doors, covers, and panels are not closed and secured in place prior to and during instrument operation.
- The integrity of safety interlocks and sensors is compromised.
- Instrument alarms and error messages are not acknowledged and acted upon.
- You contact moving parts.
- You mishandle broken parts.
- Doors, covers, and panels are not opened, closed, removed, and/or replaced with care.
- Improper tools are used for troubleshooting.

To avoid injury:

- Keep doors, covers, and panels closed and secured in place while the instrument is in use.
- Take full advantage of the safety features of the instrument. Do not defeat safety interlocks and sensors.
- Acknowledge and act upon instrument alarms and error messages.
- Keep away from moving parts.
- Report any broken parts to your Beckman Coulter Representative.
- Open/remove and close/replace doors, covers, and panels with care.
- Use the proper tools when troubleshooting.

 **CAUTION**

System integrity could be compromised and operational failures could occur if:

- This equipment is used in a manner other than specified. Operate the instrument as instructed in the Product Manuals.
- You introduce software that is not authorized by Beckman Coulter into your computer. Only operate your system's computer with software authorized by Beckman Coulter.
- You install software that is not an original copyrighted version. Only use software that is an original copyrighted version to prevent virus contamination.

 **CAUTION**

If you purchased this product from anyone other than Beckman Coulter or an authorized Beckman Coulter distributor, and, it is not presently under a Beckman Coulter service maintenance agreement, Beckman Coulter cannot guarantee that the product is fitted with the most current mandatory engineering revisions or that you will receive the most current information bulletins concerning the

product. If you purchased this product from a third party and would like further information concerning this topic, contact your Beckman Coulter Representative.

Safety Notices

Before installing, using, or maintaining the instrument, be certain that you know all the following precautions.

Installation

CAUTION

This instrument is designed to be installed by your Beckman Coulter Representative. Installation by anyone other than authorized Beckman Coulter personnel invalidates any warranty covering the instrument. Also, should the instrument need to be moved, a Beckman Coulter Representative must reinstall and re-level the instrument in its new location.

WARNING

Do not place the centrifuge near areas containing flammable or combustible fluids, or any other source of vapors that could enter the centrifuge air system and be ignited by the motor.

WARNING

Risk of operator injury. High performance centrifuge operations generate high energy levels that require precautions against sudden movements that could result from the rare event of a rotor failure. Maintain a 30-cm (1-ft) clearance envelope around and above the centrifuge. Do not install any equipment or furniture in this envelope. While the centrifuge is running, keep the envelope clear of any persons or objects and do not reach into the envelope except when required to change operating controls.

Replacement Parts

CAUTION

Risk of rotor mishap and/or improper instrument function. Do not replace any centrifuge components with parts not specified for use on this instrument.

Service

WARNING

Any servicing of this equipment that requires removal of any covers can expose parts which involve the risk of electric shock or personal injury. Make sure that the power switch is turned off, and the instrument is disconnected from the main power source, by removing its power plug from the receptacle. Refer such servicing to qualified personnel.



NOTE It is your responsibility to decontaminate the instrument and accessories before requesting service by your Beckman Coulter Representative.

Power Supply

DANGER

To reduce the risk of electrical shock, this instrument uses a three-wire electrical cord and plug to connect this equipment to earth-ground. Make sure that the matching wall outlet receptacle is properly wired and earth-grounded.

Fuse Replacement

WARNING

Fuses protect certain electrical circuits within this instrument against overcurrent conditions. The fuse is not customer replaceable. For continued protections, please contact your Beckman Coulter Representative.

Mechanical Safety

 **DANGER**

For safe operation of the equipment, observe the following:

- Use only the Beckman Coulter rotors and accessories designed for use in this instrument.
- Do not exceed the maximum rated speed of the rotor in use.
- NEVER attempt to slow or stop a rotor by hand.
- Do not move the centrifuge while the drive motor is spinning.
- NEVER attempt to override the door interlock system.
- Do not lean on the centrifuge or place items on it while it is operating.
- In the event of a power failure, do not attempt to retrieve the sample from the instrument until the rotor has come to a complete stop. The time required for a rotor to come to a complete stop can vary from 1 to 9 hours depending upon the set speed while in operation and the rotor's mass. Then follow the instructions for recovery of the sample in the [Maintenance and Troubleshooting](#) chapter.

Chemical and Biological Safety

 **DANGER**

Normal operation may involve the use of solutions and test samples that are pathogenic, toxic, or radioactive. Such materials require that you take all necessary safety precautions.

- Handle body fluids with care because they can transmit disease. No known test offers complete assurance that they are free of micro-organisms.
- Handle all infectious samples according to good laboratory procedures and methods to prevent spread of disease.
- Because spills may generate aerosols, observe proper safety precautions for aerosol containment.
- Some of the most virulent infectious agents—Hepatitis (B and C) and HIV (I-V) viruses, atypical mycobacteria, and certain systemic fungi—require additional emphasis on aerosol protection.
- Do not run toxic, pathogenic, or radioactive materials in a rotor without taking appropriate safety precautions.
- Risk Group II materials (as identified in the World Health Organization Laboratory Biosafety Manual) require biosafe containment. Materials of a higher group require more than one level of protection.
- Dispose of all waste solutions according to appropriate environmental health and safety guidelines.

Precautions with Liquids



Risk of instrument damage. Do not place containers holding liquid on or near the chamber door. Liquid, if spilled, may get into the instrument and damage electrical or mechanical components.

Volatile Liquids



This instrument is not designed for use with materials capable of developing flammable or explosive vapors. Do not centrifuge such materials (for example, chloroform or ethyl alcohol) in this instrument nor handle or store them near the centrifuge.

Summary of Instrument Labels

This section provides information for some labels and symbols appearing on the Avanti JXN series instrument housing. These labels and symbols may be associated with user-serviceable procedures. Individual hazards associated with a specific procedure in this manual may use these labels and symbols, and are included in **Warnings** or **Cautions** within the procedures for that task.

Caution Symbol



This symbol indicates a caution message and appears adjacent to an explanation or other symbols that define the caution. Please consult the *User Guide* to determine the nature of the potential hazard and any necessary actions to be taken.

RoHS Notice

These labels and materials declaration table (the Table of Hazardous Substance's Name and Concentration) are to meet People's Republic of China Electronic Industry Standard SJ/T11364-2006 "Marking for Control of Pollution Caused by Electronic Information Products" requirements.

China RoHS Caution Label



This label indicates that the electronic information product contains certain toxic or hazardous substances. The center number is the Environmentally Friendly Use Period (EFUP) date, and indicates the number of calendar years the product can be in operation. Upon the expiration of the EFUP, the product must be immediately recycled. The circling arrows indicate the product is recyclable. The date code on the label or product indicates the date of manufacture.

Universal Serial Bus (USB)

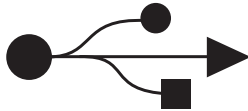

This symbol indicates the location of a universal serial bus (USB) connector.

WEEE Recycling Label



This symbol is required in accordance with the Waste Electrical and Electronic Equipment (WEEE) Directive of the European Union. The presence of this marking on the product indicates:

- the device was put on the European Market after August 13, 2005 and
- the device is not to be disposed of via the municipal waste collection system of any member state of the European Union.

It is very important that customers understand and follow all laws regarding the proper decontamination and safe disposal of electrical equipment. For Beckman Coulter products bearing this label, please contact your dealer or local Beckman Coulter office for details on the take-back program that will facilitate the proper collection, treatment, recovery, recycling and safe disposal of the device.

Multiple Compliance



This symbol indicates compliance with:

- 169502 – This label indicates recognition by a Nationally Recognized Testing Laboratory (NRTL) that the instrument has met the relevant product safety standards.

NOTE 169502 is applicable to North American models only.

- The RCM mark is intended for use on products that comply with Australian communications Media Authority (ACMA) EMC Requirements.
- Recycling – Refer to the Recycling Label section in this document.
- **CE** – A “CE” mark indicates that a product has been assessed before being placed on the market, and has been found to meet European Union safety, health, and/or environmental protection requirements.



This equipment has been designed and tested to CISPR 11 Class A. In a domestic environment it could cause radio interference, in which case, you may need to take measures to mitigate the interference.

It is advised that prior to operation of the device, the electromagnetic environment should be evaluated. Do not use this device in close proximity to sources of strong electromagnetic radiation (for example, unshielded intentional RF sources), as these could interfere with proper operation.

CAUTION Static Sensitive Area



Indicates an area of the instrument which is sensitive to static electrostatic discharge (ESD). To prevent damage due to electrostatic discharge, always wear a properly earth-grounded wrist strap while operating this instrument. For details on proper grounding, see IEEE standard P1100.

DANGER High Voltage



Operation, replacement or servicing of any components where contact with bare, live hazardous parts could occur, possibly resulting in electric shock, should only be performed by your Beckman Coulter representative.

Protective Ground

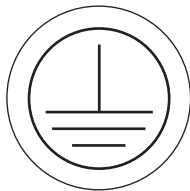

This symbol is used to indicate a protective ground. This instrument must be properly grounded. Do not under any circumstances operate the instrument unless it is properly grounded.

Rotor Rotation

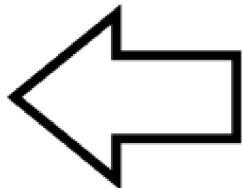

This indicates the direction of instrument rotor rotation.

Contents

Revision History, iii

Safety Notice, v

Alerts for Danger, Warning, Caution, Important, and Note, v

Safety Notices, vii

Installation, vii

Replacement Parts, vii

Service, viii

Power Supply, viii

Fuse Replacement, viii

Mechanical Safety, ix

Chemical and Biological Safety, ix

Precautions with Liquids, x

Volatile Liquids, x

Summary of Instrument Labels, x

Caution Symbol, x

RoHS Notice, x

China RoHS Caution Label, xi

Universal Serial Bus (USB), xi

WEEE Recycling Label, xi

Multiple Compliance, xii

CAUTION Static Sensitive Area, xii

DANGER High Voltage, xiii

Protective Ground, xiii

Rotor Rotation, xiii

Introduction, xxvii

Overview, xxvii

About This Manual, xxvii

Conventions, xxviii

Certification, xxviii

Scope of Manual, xxviii

CFC-Free Centrifugation, xxix

Software Copyright, xxix

Symbols, xxx

Graphics, xxxi

Description, 1-1

- Overview, 1-1
- Centrifuge Function, 1-1
- Touch Screen, 1-2
- Name Rating Plate, 1-2
- Housing and Door, 1-2
- Rotor Chamber, 1-2
- Friction Reduction System (FRS), 1-3
- Drive, 1-3
- Temperature Sensing and Control, 1-3
- Overtemp System, 1-3
- Safety Features, 1-4
- Specifications, 1-4
 - Audible Sounds, 1-6
- Available Rotors, 1-7

The Touch Screen Interface, 2-1

- Overview, 2-1
- Areas on the Screen, 2-2
 - Header Bar, 2-2
 - Home Page Button, 2-2
 - Menu Button, 2-3
 - Status Display, 2-3
 - Help Button, 2-4
 - Footer Bar, 2-4
 - Start Button, 2-4
 - Stop Button, 2-5
 - Footer Bar on the Home Page, 2-5
 - Footer Bar on Other Pages, 2-5
 - Rotor Display/Button, 2-5
 - System Name, 2-6
 - Accel and Decel Display/Button, 2-6
 - Page Display Area, 2-6
- Help Messages, 2-6
 - Item Help, 2-6
 - Global Help, 2-6
 - Exit from Help, 2-8
- About Your Instrument, 2-8

Operations, 3-1

- Overview, 3-1

Manual Operation, 3-1
Step 1: Start on the Home Page, 3-2
Step 2: Set the Speed and Rotor, 3-3
Step 3: Set the Acceleration and Deceleration Profiles, 3-4
Step 4: Set the Time, 3-6
Step 5: Set the Temperature, 3-8
Step 6: Start the Run, 3-8
Zonal and Continuous Flow Operation , 3-9
Preparing for the Run, 3-10
Starting the Run, 3-11
Loading the Sample, 3-11
Running the Sample, 3-12
Unloading the Sample, 3-12
Stopping the Run, 3-12
Finishing the Run, 3-12
Configuration, 4-1
Overview, 4-1
Managing Your Network , 4-1
Setting Up the Network , 4-1
Selecting a Printer, 4-2
Setting Up Email , 4-2
Setting Up VNC, 4-3
Enabling API, 4-4
Setting Up a Network, 4-4
Managing Users, 4-5
Adding Users, 4-5
Requiring Login, 4-6
PIN Expiration and Logout Timer, 4-6
User Options, 4-7
Managing Rotors, 4-8
Adding Rotors, 4-8
Managing Reports, 4-9
User Access, 4-9
Filtering Data, 4-10
Graphing Data, 4-12
Print Data, 4-13
Export Data, 4-14
Auto Print and Auto Export Run History Data, 4-16
Enabling Auto Print , 4-16
Enabling Auto Export, 4-16
Enabling Run Comments, 4-17
Signature Options , 4-18
Managing Qualifications , 4-21

Programs, 5-1

- Overview, 5-1
- Creating Programs, 5-2
- Running Programs, 5-6
- Editing Programs, 5-7
- Deleting Programs, 5-8

Functional Pages, 6-1

- Overview, 6-1
- Home Page, 6-3
- Home Page (Run in Progress), 6-5
- Set Speed Page, 6-6
- Select Rotor Page (Library), 6-7
- Set Time Page, 6-8
- Delay Start Page, 6-9
- Set Speed ω^2t Time Page, 6-10
- Set Temperature Page, 6-11
- Set Acceleration/Deceleration Profiles Page, 6-12
 - Example Acceleration and Deceleration Settings, 6-13
- Login Page, 6-13
- Select Program Page, 6-14
- New/Edit/View Program Page, 6-15
- Select Rotor Page (Catalog), 6-17
- New/Edit Step Page, 6-18
- Program Log Page, 6-19
- Export Page, 6-20
- Authorize Users Page, 6-21
- Import Page, 6-22
- Real-Time Run Data/Historical Run Data Page, 6-23
- Run Graph Options Page, 6-24
- Run History Page, 6-25
- Run History Filter Page, 6-27
- Before Run/After Run Comment Page, 6-28
- Menu Page, 6-29
- System Options Page, 6-30

The Basic Tab, 6-30
The System Tab, 6-31
The Network Tab, 6-32
The Users Tab, 6-33
The Reports Tab, 6-34
The Qualification Tab, 6-35
Select Language Page, 6-36
User Options Page, 6-37
Max Temperature Offset Page, 6-38
Reset User PIN Page, 6-39
Select Image Page, 6-40
Set Date and Time Page, 6-41
System Log Page, 6-42
Manage Rotors Page, 6-43
Add to Rotor Library Page, 6-44
Diagnostic History Page, 6-45
Set Sound Page, 6-46
Custom Sounds Page, 6-47
Archive Data Page, 6-48
Setup Network Page, 6-49
Setup Network Path, 6-50
Select Printer Page, 6-51
Setup Email Page, 6-52
Setup VNC Page, 6-53
Manage Users Page, 6-54
Add/Edit User Page, 6-55
Authorize Programs Page, 6-56
Rotor Catalog Page, 6-57
About Page, 6-58
Zonal Authorization Page, 6-59
Zonal Operation Page, 6-60
Maintenance and Troubleshooting, 7-1
Overview, 7-1
Field Service, 7-1
Maintenance, 7-1
Cleaning, 7-2

- Tube Breakage, 7-3
- Decontamination, 7-3
- Sterilization and Disinfection, 7-4
- Replacing the Air Filter, 7-4
- Checking the Vacuum Pump, 7-5
- Diagnostics/User Messages, 7-6
- Accessing the Rotor in Case of Power Failure, 7-6
- JCF-Z Rotor Identification, 7-11
- Storage and Transportation, 7-12
- Supply List, 7-12
 - Replacement Parts and Supplies, 7-12
- Preinstallation Requirements, A-1**
 - Preinstallation Requirements, A-1
 - Electrical Requirements, A-1
 - Single and Three-Phase Power Connections, A-2
 - Additional Requirements for Three-Phase Power Connections, A-4
 - Space and Location Requirements, A-4
 - Using J2 Series Rotors in the Avanti JXN Series, A-5
 - Checking for Rotor Drive Pins, A-5
 - Using the JCF-Z Continuous Flow/Zonal Rotor, A-7
 - Zonal Bracket Kits, A-7
- Temperature Calibration Procedure, B-1**
 - Introduction, B-1
- Diagnostics, C-1**
 - Overview, C-1
 - Diagnostics/User Messages Chart, C-1
- HEPA Filter Replacement Instructions for the Avanti JXN Series Centrifuges, D-1**
 - HEPA Filter Replacement, D-1
- Abbreviations**
- Index**
- Beckman Coulter, Inc.
Avanti JXN Series Centrifuge Warranty**
- Related Documents**

Illustrations

- 2.1 Home Page, 2-1
- 2.2 Header Bar, 2-2
- 2.3 Home Page Button, 2-2
- 2.4 Menu Button, 2-3
- 2.5 Ready Status, 2-3
- 2.6 Header Bar - Ready Status, 2-3
- 2.7 Header Bar - Running Status, 2-3
- 2.8 Header Bar - Stopping Status, 2-4
- 2.9 Header Bar - Warning Message, 2-4
- 2.10 Header Bar - Error Message, 2-4
- 2.11 Help Button, 2-4
- 2.12 Start Button, 2-4
- 2.13 Stop Button, 2-5
- 2.14 Footer Bar - Home Page, 2-5
- 2.15 Footer Bar on Other Pages, 2-5
- 2.16 Item Help Button, 2-6
- 2.17 Global Help Button attached to Help Button, 2-7
- 2.18 Home Page Help with ghost image, 2-7
- 2.19 Transparency Button, 2-7
- 2.20 Home Page Help with opaque screen, 2-8
- 2.21 Help Navigation Buttons, 2-8
- 2.22 About Page, 2-9
- 3.1 Home Page, 3-2
- 3.2 Zonal Operation Page with Cancel Button, 3-3
- 3.3 Set Speed Page, 3-3
- 3.4 Select Rotor, 3-4
- 3.5 Set Acceleration/Deceleration Profiles Page, 3-5
- 3.6 Set Time Page, 3-6
- 3.7 Delay Start Page, 3-7
- 3.8 Set Temperature Page, 3-8
- 3.9 Start Button, 3-9
- 3.10 Zonal Page, 3-10
- 3.11 Zonal Page, 3-11
- 4.1 Run History (Filtered View), 4-9

4.2	Run History Button, 4-10
4.3	Run History Filter, 4-10
4.4	Set From Date and Time, 4-11
4.5	Run Graph Button, 4-12
4.6	Run History Button, 4-12
4.7	Run Graph Options, 4-13
4.8	Run Graph Button, 4-13
4.9	Run History Button, 4-14
4.10	Run History Button, 4-14
4.11	Run History, 4-15
4.12	Run History Button, 4-15
4.13	Before Run Comment, 4-18
4.14	Signature, 4-20
4.15	System Option, Qualification, 4-21
4.16	Qualification Management, 4-22
5.1	Program Button, 5-2
5.2	Home, 5-2
5.3	Select Program, 5-3
5.4	Unnamed program, 5-3
5.5	New Program Name, 5-4
5.6	Set Acceleration/Deceleration Profiles, 5-4
5.7	Select Rotor, 5-5
5.8	New Step, 5-5
5.9	New Step in a numbered sequence, 5-6
5.10	Program Button, 5-7
5.11	Program Button, 5-7
5.12	Program Button, 5-8
6.1	Home Page, 6-3
6.2	Home Page (Run in Progress), 6-5
6.3	Set Speed Page (Rotor Selected), 6-6
6.4	Select Rotor Page (Library), 6-7
6.5	Set Time Page, 6-8
6.6	Delay Start Page, 6-9
6.7	Set Speed ω^2t Time Page, 6-10
6.8	Set Temperature Page, 6-11
6.9	Set Acceleration/Deceleration Profiles Page, 6-12
6.10	Login Page, 6-13
6.11	Select Program Page, 6-14

- 6.12 [New Program Page](#), 6-15
- 6.13 [Edit Program Page](#), 6-15
- 6.14 [View Program Page](#), 6-16
- 6.15 [Select Rotor Page \(Catalog\)](#), 6-17
- 6.16 [New Step Page](#), 6-18
- 6.17 [Edit Step Page](#), 6-18
- 6.18 [Program Log Page](#), 6-19
- 6.19 [Export Page](#), 6-20
- 6.20 [Authorize Users Page](#), 6-21
- 6.21 [Import Page](#), 6-22
- 6.22 [Real-Time Run Data Page](#), 6-23
- 6.23 [Historical Run Data Page](#), 6-23
- 6.24 [Run Graph Button](#), 6-24
- 6.25 [Run Graph Options Page](#), 6-24
- 6.26 [Run History Page](#), 6-25
- 6.27 [Run History Page \(E-Signature Enabled\)](#), 6-26
- 6.28 [Run History Button](#), 6-26
- 6.29 [Run History Filter Page](#), 6-27
- 6.30 [Before Run Comment Page](#), 6-28
- 6.31 [Menu Page](#), 6-29
- 6.32 [System Options Page, Basic Tab](#), 6-30
- 6.33 [System Options Page, System Tab](#), 6-31
- 6.34 [System Options Page, Network Tab](#), 6-32
- 6.35 [System Options Page, Users Tab](#), 6-33
- 6.36 [System Options Page, Reports Tab](#), 6-34
- 6.37 [Systems Options Page, Qualification Tab](#), 6-35
- 6.38 [Select Language Page](#), 6-36
- 6.39 [User Options Page](#), 6-37
- 6.40 [Max Temperature Offset Page](#), 6-38
- 6.41 [Reset User PIN Page](#), 6-39
- 6.42 [Select Image Page \(Avatar\)](#), 6-40
- 6.43 [Select Image Page \(Background\)](#), 6-40
- 6.44 [Set Date and Time Page](#), 6-41
- 6.45 [System Log Page](#), 6-42
- 6.46 [Manage Rotors Page](#), 6-43
- 6.47 [Add to Rotor Library Page](#), 6-44
- 6.48 [Diagnostic History Page](#), 6-45
- 6.49 [Set Sound Page](#), 6-46

6.50	Custom Sounds Page, 6-47
6.51	Archive Data Page, 6-48
6.52	Setup Network Page, 6-49
6.53	Setup Network Path, 6-50
6.54	Select Printer Page, 6-51
6.55	Setup Email Page, 6-52
6.56	Setup VNC Page, 6-53
6.57	Manage Users Page, 6-54
6.58	Add User Page, 6-55
6.59	Authorize Programs Page, 6-56
6.60	Rotor Catalog Page, 6-57
6.61	About Page, 6-58
6.62	Zonal Authorization Page, 6-59
6.63	Zonal Mode Button, 6-59
6.64	Zonal Operation Page, 6-60
7.1	Front View of Vacuum Pump, 7-5
7.2	Emergency Door Release Latch Access, 7-7
7.3	Manual Door Release, 7-8
7.4	Venting the Chamber Vacuum - Removing the Red Hose, 7-9
7.5	Venting the Chamber Vacuum - Replacing the Red Hose, 7-10
7.6	Front Panel Retaining Strip, 7-11
A.1	Single-Phase Electrical Requirements, A-3
A.2	Three-Phase “Y” Electrical Requirements, A-3
A.3	Correct and Incorrect Three-Phase Power Configurations, A-4
A.4	Checking the Rotor for Drive Pins, A-6
D.1	HEPA Filter Replacement, D-1

Tables

1.1	Avanti JXN Series Specifications, 1-4
1.2	Available Rotors, 1-7
4.1	User Levels, 4-5
6.1	Acceleration and Deceleration Profiles, 6-13
7.1	Replacement Parts, 7-12
A.1	Nominal Supply Voltage Ratings for the Avanti JXN Series, A-1
A.2	Required Wire Connections, A-3
C.1	Diagnostics/User Messages Chart, C-1

Overview

This introduction contains the following information:

- About This Manual
- Conventions
- Certification
- Scope of Manual
- CFC-Free Centrifugation
- Software Copyright
- Symbols
- Graphics

About This Manual

The information in your User's Manual is organized as follows:

CHAPTER 1, Description

Describes the Avanti JXN series centrifuge components and their functions. It also describes system safety features and centrifuge controls and displays.

CHAPTER 2, The Touch Screen Interface

Describes the touch screen interface for the Avanti JXN series.

CHAPTER 3, Operations

Describes the Manual Operation and the Zonal and Continuous Flow Operation.

CHAPTER 4, Configuration

Describes configuration options for the system and the effects on system functionality.

CHAPTER 5, Programs

Describes the functionality of creating and storing programs in the centrifuge memory.

CHAPTER 6, Functional Pages

Describes the functional pages used to control the Avanti JXN series.

CHAPTER 7, Maintenance and Troubleshooting

Contains care and maintenance procedures to be performed regularly.

Additionally, this manual includes several appendices that cover a range of topics including Preinstallation, Temperature Calibration, Diagnostics, and Legal Notices.

This manual also includes a list of Abbreviations (including acronyms), and the Beckman Coulter, Inc. Customer End User License Agreement.

Conventions

This manual applies the following conventions:

- **Bold** font indicates a screen icon or menu item on the Workstation screen.
- *Italics* font indicates screen text displayed by the Workstation.
- **Blue and underlined** text indicates that you can click on the text to access related information.
- The term 'select' is used to indicate either one or both of the following actions:
 - to tap or touch your finger on the touch screen
 - to click with a mouse

IMPORTANT IMPORTANT is used for statements that add value to a particular step or procedure being performed. Following the advice in the IMPORTANT adds benefit to the performance of a piece of equipment or to a process.

NOTE NOTE is used to call attention to notable information that should be followed during use or maintenance of this equipment.

Certification

To ensure full system quality, Beckman Coulter Avanti JXN series have been manufactured in a facility that maintains certifications to both ISO 9001:2008 and ISO 13485:2003. They have been designed and tested to conform to (when used with Beckman Coulter rotors) the laboratory equipment requirements of applicable regulatory agencies. Declarations of conformity and certificates of compliance are available at www.beckman.com.

Scope of Manual

This manual is designed to familiarize you with the Avanti JXN series, its functions, specifications, operation, and routine operator care and maintenance. Read this entire manual, especially the

safety notices and all safety-related information, before operating the instrument or performing maintenance.

NOTE If the instrument is used in a manner other than specified in this manual, the safety and performance of this equipment could be impaired. Further, the use of any equipment other than that recommended by Beckman Coulter has not been evaluated for safety. Use of any equipment not specifically recommended in this manual and/or the appropriate rotor manual is the sole responsibility of the user.

CFC-Free Centrifugation









To ensure minimal environmental impact, no CFCs are used in the manufacture or operation of the Avanti JXN series centrifuge.

Software Copyright

The software and other information incorporated into the Avanti JXN series is protected by international copyright laws. Unauthorized copying, use, distribution, transfer, or sale is a violation of those laws that may result in civil or criminal penalties.

Symbols

Symbol Symbol Symbole Símbolo	Simbolo 記号 符号	Title / Titel / Titre / Titolo / Titolo / 名称 / 名称
		Dangerous voltage Gefährliche elektrische Spannung Courant haute tension Voltaje peligroso Pericolo: alta tensione 危険電圧 危险电压
		Attention, consult accompanying documents Achtung! Begleitpapiere beachten! Attention, consulter les documents joints Atención, consulte los documentos adjuntos Attenzione: consultare le informazioni allegate 注意、添付資料を参照のこと 注意，请参阅附带的文件
		On (power) Ein (Netzverbindung) Marche (mise sous tension) Encendido Acceso (sotto tensione) 入（電源） 开（电源）
		Off (power) Aus (Netzverbindung) Arrêt (mise hors tension) Apagado Spento (fuori tensione) 切（電源） 关（电源）
		Protective earth (ground) Schutzleiteranschluß Liaison à la terre Puesta a tierra de protección Collegamento di protezione a terra 保護アース（接地） 保护接地
		Earth (ground) Erde Terre Tierra Scarica a terra アース（接地） 接地
		Biohazard Potentiell infektiösem Material Riesgo biológico Risque biologiqu Pericolo biologico Material infecioso potencial 可能的传染性物 潜在的な感染性物質

Graphics

All graphics, including screens and printouts, are for illustration purposes only and must not be used for any other purpose. The graphics that your system generates may differ from what is displayed in this manual.

Overview

This section describes the Avanti JXN series centrifuge components and their functions. It also describes system safety features and centrifuge controls and displays. Refer to the applicable rotor manual for rotor descriptions.

This chapter contains information about:

- [Centrifuge Function](#)
- [Touch Screen](#)
- [Name Rating Plate](#)
- [Housing and Door](#)
- [Rotor Chamber](#)
- [Friction Reduction System \(FRS\)](#)
- [Drive](#)
- [Temperature Sensing and Control](#)
- [Overtemp System](#)
- [Safety Features](#)
- [Specifications](#)
- [Available Rotors](#)

Centrifuge Function

The Avanti JXN series is a refrigerated centrifuge that generates centrifugal forces required for a wide variety of applications. Together with the Beckman Coulter rotors designed for use in this centrifuge, applications include:

- Routine processing such as sample preparations, pelleting, extractions, purifications, concentrations, phase separations, and spin column and spin filter centrifugations.
- Rapid sedimentation of protein precipitates, large particles, and cell debris.
- Preparation of subcellular organelles such as mitochondria, nuclei, chloroplasts, and crude microsomes.
- Separation of blood cells and cellular components.
- Pelleting of prokaryotic and eukaryotic cells.
- Gradient separation, for example, Ficoll-Hypaque and Percoll.
- Nucleic acid precipitation.

- Virus isolation.
- Bacteriophage isolation.

The Avanti JXN series centrifuge design features a brushless switched-reluctance drive motor*, an automatic rotor identification system, FRS (friction reduction system), vacuum control circuitry, temperature control system, and programmable acceleration and deceleration times.

Touch Screen

The touch screen is both the information display and the control input for the instrument. As they are needed, control buttons appear on the screen. When you select a button, you activate that control.

Each component of the touch screen interface is explained in the following chapters.

Name Rating Plate

A name rating plate is affixed to the rear of the instrument. Always mention the serial number and model number (available on the [About Page](#)) when contacting Beckman Coulter regarding your instrument.

Housing and Door

The instrument control housing, door assembly, and cover panels are made from a highly durable plastic.

The door is opened by stepping on a foot pedal, which is located at the bottom right front of the instrument. The door is hinged at the back left to open at a 60 degree angle to the centrifuge side panels, providing clearance for loading and unloading of the centrifuge.

In the event of a power failure, the door can be manually unlocked for sample recovery (see [Accessing the Rotor in Case of Power Failure](#) in [CHAPTER 7, Maintenance and Troubleshooting](#)).

Rotor Chamber

The rotor chamber is made of stainless steel to resist corrosion. A rubber gasket around the chamber opening ensures sealing.

NOTE Instrument gaskets have not been qualified as bioseals for aerosol containment.

* Manufactured under license from Switched Reluctance Drives Limited, Harrogate, U.K.

Friction Reduction System (FRS)

The friction reduction system (FRS) uses a mechanical rotary vane vacuum pump to reduce chamber pressure. The pump turns on after the run is started, before rotor friction reaches a high level. When the required vacuum level is reached, the pump turns off. Vacuum in the chamber is vented during rotor deceleration.

Drive

The drive spindle is directly driven by a brushless, high-torque, switched-reluctance motor. The instrument's resilient suspension minimizes disturbance of the sample during acceleration and deceleration, and reduces damage to the drive spindle if an imbalance occurs during centrifugation.

Temperature Sensing and Control

The temperature control system is cooled by circulation of a non-CFC-based refrigerant. A thermistor in the rotor chamber continuously monitors the chamber temperature. The system calculates the chamber temperature required to maintain the set temperature. Although the chamber temperature fluctuates during operation, the rotor's large mass keeps the sample temperature substantially constant. At the end of a run, the system continues controlling the temperature to prevent freezing or overheating of the sample.

Overtemp System

An overtemp (over temperature) system provides flexibility, sample protection, and safety for the user.

- The maximum allowable deviation above the Set Temperature is configured by the user. The default setting is 4°C.
- For each run the user sets the desired run temperature.
- If the system is configured to shutdown when the set temperature is exceeded, the system shuts down using maximum brake when the actual temperature exceeds the set temperature by the overtemp setting.
- To protect the instrument hardware, the system shuts down when the over temperature is reached. The shutdown cannot be disabled by the user. The system shuts down using maximum brake when its over temperature shutdown point is exceeded. For a listing of the specified temperature for each instrument, see [Specifications](#).

Safety Features

Avanti JXN series centrifuges have been designed and tested to operate safely indoors at altitudes up to 2000 m (6562 ft). Safety features include the following:

- An electromechanical door lock system prevents operator contact with spinning rotors and prevents run initiation unless the door is closed and locked. The door locks when **START** is pressed, or when the POWER switch is turned off. The exception to this is **ZONAL** mode, in which open-door operation up to 3000 RPM is allowed.
- A steel casing surrounds the rotor chamber to provide operator protection in the unlikely event of a rotor mishap.
- **Dynamic Rotor Inertia Check (DRIC):** As the rotor accelerates, rotor inertia is measured and the rotor energy is calculated for the speed set by the user. If the calculated rotor energy is determined to be excessive, the instrument will stop the run and issue a diagnostic message.
- An imbalance detector monitors the system during operation, causing automatic shutdown if rotor loads are severely out of balance.

Specifications

Only values with tolerances or limits are guaranteed data. Values without tolerances are informative data, without guarantee.

Table 1.1 Avanti JXN Series Specifications

Specifications	Description	Avanti JXN-26	Avanti JXN-30
Speed	Setting range	500 to 26,000 RPM (in 10 RPM increments) or equivalent RCF (in 10 x g increments)	500 to 30,000 RPM (in 10 RPM increments) or equivalent to RCF (in 10 x g increments)
	Speed control (1,000 to 10,000 RPM)	±10 RPM	
	Speed control (10,001 to max speed)	±0.1%	±0.15%
Time	Setting range	1 min to 99 hr 59 min, ω^2t , or continuous (hold)	
	Actual display	Indicates time remaining (timed run), ω^2t , or elapsed time (hold run)	
	ω^2t setting range	Up to 2.6682×10^{12} radians squared per second	Up to 3.5524×10^{12} radians squared per second
	ω^2t actual display	Indicates accumulated centrifugal effect to five significant digits (in exponential notation)	

Table 1.1 Avanti JXN Series Specifications

Specifications	Description	Avanti JXN-26	Avanti JXN-30
Temperature	Setting range	-10 to +40°C (in 1°C increments)	-20 to +40°C (in 1°C increments)
	Accuracy	±2°C of chamber temperature (after equilibration) ^a	
	Ambient temperature range	16 to 38°C ^b	
	Over temperature shutdown point ^c	50°C	55°C
	Cooling fluid	Refrigerant R452A (HFO)	
Accel/Decel	Acceleration	Maximum, timed (1 to 10 min from 0 to 500 RPM)	
	Deceleration	Maximum, timed (1 to 10 min from 500 to 0 RPM), or coast	
Dimensions	Width	71 cm (28 in.)	
	Depth	86 cm (34 in.)	
	Height (with door closed)	86 cm (34 in.)	
	Height (to top of control head)	120 cm (47.3 in.)	
	Height (to top of open door)	149 cm (58.5 in.)	141 cm (55.5 in.)
	Weight	290 kg (640 lb)	310 kg (680 lb)
Ventilation Clearances	Sides	7.6 cm (3 in.)	
	Rear	16 cm (6.25 in.)	
Finishes	Top surfaces	Uncoated plastic	Painted plastic
	Front surfaces	Painted plastic	
	Other surfaces	Acrylic baking enamel on metal surfaces	
Electrical	Power requirement	200/208/240V, single phase instrument: 180-264 VAC, 30 A, 50/60 Hz 230V, single phase instrument: 180-264 VAC, 30 A, 50 Hz 220/380V plus neutral 3-phase ^d instrument: 313-457 VAC plus neutral, 16A, 50 Hz	
	Electrical supply	Class 1	
	Installation (overvoltage category)	II	

Table 1.1 Avanti JXN Series Specifications

Specifications	Description	Avanti JXN-26	Avanti JXN-30
Environmental	Noise output (1 m in front of instrument, 1.5 m above the floor)	62 dBA	
	Maximum heat dissipation under steady-state conditions	5120 Btu/h (1.5 kW)	
	Humidity restrictions	<80% (noncondensing)	
	Pollution degree	2 ^e	
	HEPA filter	Available	

- a. Proprietary algorithm applied to provide an estimated sample temperature.
- b. To reach temperatures above ambient, the centrifuge is dependent on the frictional heat generated inside the chamber during operation. At low run speeds or low ambient temperatures, the centrifuge may not be able to achieve some higher temperatures.
- c. If the system reaches this temperature, it will issue a diagnostic and shut down using maximum brake.
- d. Unbalanced three-phase. Split for single-phase operation internally.
- e. Normally, only nonconductive pollution occurs. Occasionally, however, a temporary conductivity caused by condensation must be expected.

Audible Sounds

The Avanti JXN series instrument makes an audible sound for the following events:

- Boot up
- Start of Run
- End of Run
- Diagnostics/Alert
- Door open during Zonal mode
- Key Click

Sound volume can be regulated through the [Set Sound Page](#), and some sounds can be customized through the System Options. See [Custom Sounds Page](#).

The Door Open during Zonal mode sound cannot be changed or muted. It will play every 5 seconds when the door could be open.

Available Rotors

Refer to the applicable rotor manual for complete rotor descriptions.

Table 1.2 Available Rotors^a

Rotor Profile	Description	JXN-26 Max RPM ^b	JXN-30 Max RPM ^b	JXN-26 Max RCF (× g)	JXN-30 Max RCF (× g)	Max Capacity	Rotor Manual Number
	JA-30.50 Ti Fixed Angle, 34° (8 place) $r_{\max} = 108$ mm	26,000	30,000	81,770	108,860	8 × 50 mL	J-TB-070
	JA-25.50 Fixed Angle, 34° (8 place) $r_{\max} = 108$ mm	25,000	25,000	75,600	75,600	8 × 50 mL	J-TB-056
	JA-25.15 Fixed Angle, 25° (24 place) $r_{\max} = 106$ mm (outer row) $r_{\max} = 86$ mm (inner row)	25,000	25,000	74,200 60,200	74,200 60,200	24 × 15 mL	J-TB-057
	JA-21 Fixed Angle, 40° (18 place) $r_{\max} = 102$ mm	21,000	21,000	50,380	50,380	18 × 10 mL	J-TB-002
	JA-20.1 Fixed Angle, 23° (32 Place) $r_{\max} = 115$ mm (outer row) $r_{\max} = 98$ mm (inner row)	20,000	20,000	51,520 43,900	51,520 43,900	32 × 15 mL	J-TB-022
	JA-20 Fixed Angle, 34° (8 place) $r_{\max} = 108$ mm	20,000	20,000	48,380	48,380	8 × 50 mL	J-TB-003

Table 1.2 Available Rotors^a (Continued)

Rotor Profile	Description	JXN-26 Max RPM ^b	JXN-30 Max RPM ^b	JXN-26 Max RCF (× g)	JXN-30 Max RCF (× g)	Max Capacity	Rotor Manual Number
	JA-18.1 Fixed Angle (24 place) 45° adapter $r_{\text{max}} = 116 \text{ mm}$	18,000	18,000	42,090	42,090	24 × 1.8 mL	J-TB-037
	25° adapter $r_{\text{max}} = 112 \text{ mm}$	17,000	17,000	36,250	36,250	24 × 1.8 mL	
	JA-18 Fixed Angle, 23° (10 place) $r_{\text{max}} = 132 \text{ mm}$	18,000	18,000	47,900	47,900	10 × 100 mL	J-TB-035
	JA-17 Fixed Angle, 25° (14 place) $r_{\text{max}} = 132 \text{ mm}$	17,000	17,000	39,810	39,810	14 × 50 mL	J-TB-017
	JLA-16.250 Fixed Angle, 25° (6 place) $r_{\text{max}} = 134 \text{ mm}$	16,000	16,000	38,420	38,420	6 × 250 mL	J-TB-072
	JA-14.50 Fixed Angle, 35° (16 place) $r_{\text{max}} = 160 \text{ mm}$	14,000	14,000	35,050	35,050	16 × 50 mL	B32164
	JA-14 Fixed Angle, 25° (6 place) $r_{\text{max}} = 137 \text{ mm}$	14,000	14,000	30,070	30,070	6 × 250 mL	J-TB-004
	JLA-12.500 Fixed Angle, 30° (6 place) $r_{\text{max}} = 165 \text{ mm}$	12,000	12,000	26,890	26,890	6 × 500 mL	C70011
	JA-12 Fixed Angle, 35° (12 place) $r_{\text{max}} = 144 \text{ mm}$	12,000	12,000	23,220	23,220	12 × 50 mL	J-TB-051

Table 1.2 Available Rotors^a (Continued)

Rotor Profile	Description	JXN-26 Max RPM ^b	JXN-30 Max RPM ^b	JXN-26 Max RCF (× g)	JXN-30 Max RCF (× g)	Max Capacity	Rotor Manual Number
	JA-10 Fixed Angle, 25° (6 place) $r_{\max} = 158$ mm	10,000	10,000	17,700	17,700	6 × 500 mL	J-TB-006
	JLA-10.500 Fixed Angle, 20° (6 place) $r_{\max} = 166$ mm	10,000	—	18,590	—	6 × 500 mL	J-TB-048
	F10BCI-6x500y Fixed Angle, 23° (6 place) $r_{\max} = 158$ mm	10,000	10,000	17,700	17,700	6 × 500 mL	—
	JLA-9.1000 Fixed Angle, 20° (4 place) $r_{\max} = 185$ mm	9,000	9,000	16,780	16,780	4 × 1000 mL	J-TB-073
	JLA-8.1000 Fixed Angle, 20° (6 place) $r_{\max} = 222.8$ mm	8,000	—	15,970	—	6 × 1000 mL	J-TB-073
	JS-13.1 Swinging Bucket (6 place) $r_{\max} = 140$ mm	13,000	13,000	26,500	26,500	6 × 50 mL	J-TB-036
	JS-24.38 Swinging Bucket (6 place) $r_{\max} = 161$ mm	10,000	24,000	18,030	103,860	6 × 38.5 mL	J-TB-058
	JS-24.15 Swinging Bucket (6 place) $r_{\max} = 171.3$ mm	10,000	24,000	19,190	110,510	6 × 15 mL	J-TB-058

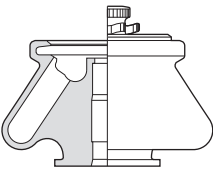
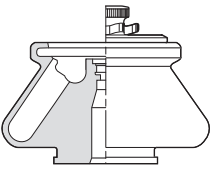
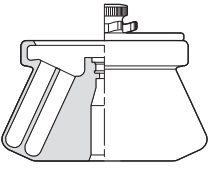
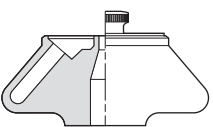
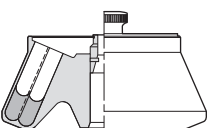
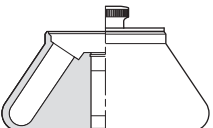
Table 1.2 Available Rotors^a (Continued)

Rotor Profile	Description	JXN-26 Max RPM ^b	JXN-30 Max RPM ^b	JXN-26 Max RCF (× g)	JXN-30 Max RCF (× g)	Max Capacity	Rotor Manual Number
	<p>JS-7.5 Swinging Bucket (4 place) $r_{\max} = 165$ mm Four bucket types:</p> <ul style="list-style-type: none"> • 4x250 mL • 12x50 mL (4x3x50) • 16x50 mL (4x4x50) • 24x5 mL (6x6x5) 	7,500	7,500	10,400	10,400	4 × 250 mL	J-TB-007
	<p>JS-5.3 Swinging Bucket (4 place) $r_{\max} = 194.8$ mm</p>	5,300	—	6,870	—	24 microplates 8 deep-well plates 4 square-well plates	J-TB-089
	<p>JS-4.3 Swinging Bucket (4 place) $r_{\max} = 204$ mm</p>	4,300	—	4,220	—	4 × 750 mL	J-TB-050
	<p>JS-4.0 Swinging Bucket (4 place) $r_{\max} = 226$ mm</p>	4,000	—	4,050	—	4 × 1 liter 4 blood bags 12 microplates 148 RIA tubes	J6-TB-006

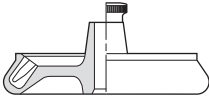
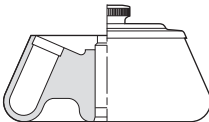
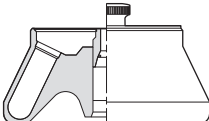
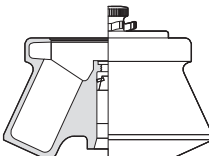
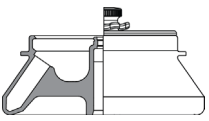
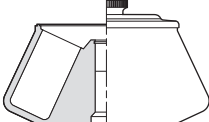
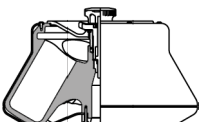
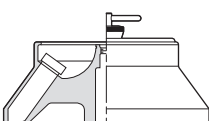
Table 1.2 Available Rotors^a (Continued)

Rotor Profile	Description	JXN-26 Max RPM ^b	JXN-30 Max RPM ^b	JXN-26 Max RCF (× g)	JXN-30 Max RCF (× g)	Max Capacity	Rotor Manual Number
	JCF-Z Continuous Flow/ Zonal Rotor	20,000	20,000	39,870	39,870	660 mL (standard core)	JCFZ-IM
				39,870	39,870	1250 mL (large core)	
				36,290	36,290	240 mL (small core)	
				39,870	39,870	1750 mL (reorienting gradient)	
				39,870	39,870	1900 mL (standard zonal)	

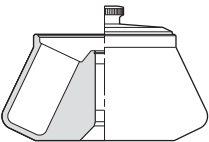
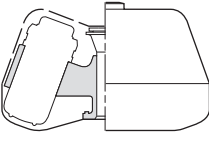
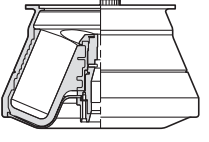
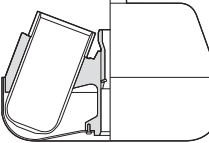
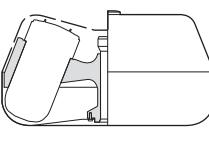
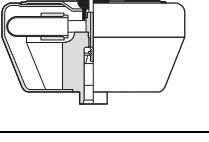
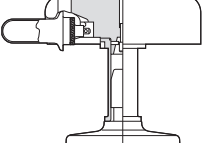
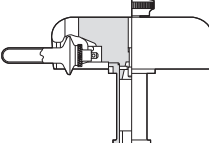
a. When operating at the maximum speed for the rotor, the minimum temperature cannot be selected for all rotors. Refer to the specific rotor IFU for details.

b. Maximum speeds are based on a solution density of 1.2 g/mL with the following exceptions: the JA-18.1 rotor is rated for a density of 1.4 g/mL; the JCF-Z rotor is rated for a density of 1.45 g/mL.

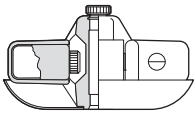
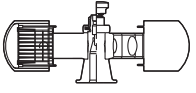
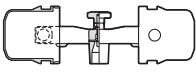
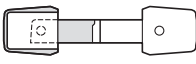
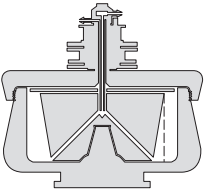
Description
Available Rotors

CHAPTER 2

The Touch Screen Interface

Overview

This chapter describes the touch screen interface for the Avanti JXN series. Except for the power switch, all the controls for the instrument are programmed controls that appear on the touch screen.

Figure 2.1 Home Page



This chapter contains information about:

- [Areas on the Screen](#)
- [Help Messages](#)
- [About Your Instrument](#)

Areas on the Screen

The items on the screen may change, depending on the state of the instrument. There are three areas where items appear on the screen:

- The Header Bar
- The Footer Bar
- The Page Display Area

Header Bar

Figure 2.2 Header Bar



The area across the top of the screen is called the Header Bar, containing four important items:

- **Home** Page Button
- **Menu** Button
- **Status** Display
- **Help** Button

The following sections explain these items.

Home Page Button

Figure 2.3 Home Page Button



The **Home Page** Button displays the [Home Page](#) from any other page. When you use Zonal Mode, the **Zonal Operation** Page replaces the **Home** Page.

Menu Button

Figure 2.4 Menu Button



The **Menu** Button displays the Menu page, including the following functions:

- Options
- Rotor Catalog
- About
- Zonal Operation
- Service Mode

The menu options are explained in the following chapters.

Status Display

Figure 2.5 Ready Status



The Status Display is in the middle of the Header Bar and shows you the current instrument status, the current program (if selected) and program step (if running). The Status Display also shows when a delayed run is scheduled or pending, a remote user is logged in, or service mode is enabled. The background color of the header bar changes with the type of status:

- Blue background: system ready (no run in progress).

Figure 2.6 Header Bar - Ready Status



- Green background: in operation (run in progress).

Figure 2.7 Header Bar - Running Status



- Green background: in operation (stop in progress).

Figure 2.8 Header Bar - Stopping Status



- Yellow background: warning message.

Figure 2.9 Header Bar - Warning Message



- Red background: error message.

Figure 2.10 Header Bar - Error Message

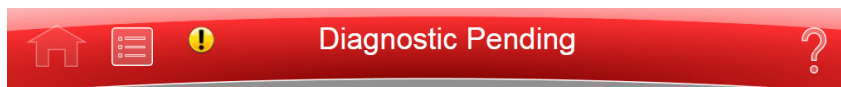

Help Button

Figure 2.11 Help Button



The **Help** button gives you access to the built-in online help messages. Help messages are described at the end of this chapter in [Help Messages](#).

Footer Bar

The bottom of the touch screen always shows the footer bar. The footer bar appears in two different ways, but it always has the **Start** Button at the left and the **Stop** Button at the right.

Start Button

Figure 2.12 Start Button



The **Start** Button begins a run with the current settings. Use it only after you have set the parameters for the run.

Stop Button

Figure 2.13 Stop Button



The **Stop** button stops the current run immediately. This is ordinarily only used for emergencies or if you mistakenly set too long a run time.

Footer Bar on the Home Page

On the **Home** Page, the middle of the Footer Bar shows three Items:

- The **Rotor** Display/Button
- The System Name
- The **Accel** and **Decel** Display/Button

Figure 2.14 Footer Bar - Home Page

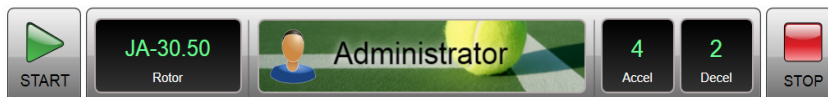

Each of these is explained below.

Footer Bar on Other Pages

When not on the Home Page, the three buttons for Speed, Time and Temperature appear in the Footer Bar for easy access. To set Acceleration or Deceleration profiles, select the **Home** button to return to the **Home** Page. The following items are described in detail within the **Home** Page section of the next chapter:

- The **Set Speed** Display/Button
- The **Set Time** Display/Button
- The **Set Temp** Display/Button

Figure 2.15 Footer Bar on Other Pages

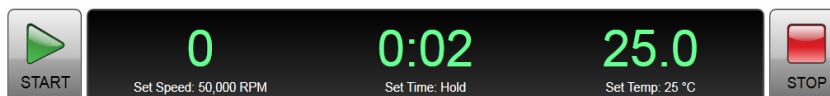

Rotor Display/Button

As a display, the **Rotor** Display/Button shows the current selected rotor. Select the button to display the Select Rotor page, described in [CHAPTER 6, Functional Pages](#).

System Name

The system name displays the system name entered as one of the options on the [System Options Page](#). This section also displays the user currently logged in to the system (if enabled), and the avatar and background (if selected) for that user.

Accel and Decel Display/Button

These are two displays that, together, act as a single button.

As a display, each shows the currently selected acceleration or deceleration profile. Select the button to display the [Set Acceleration/Deceleration Profiles Page](#), described in [CHAPTER 6](#).

Page Display Area

The Page Display Area is the main display area between the Header Bar and the Footer Bar. The pages and help messages all appear in this area. The pages are all described in [CHAPTER 6](#).

Help Messages

When you first select the **Help** Button, a number of new buttons appear on the screen, giving you three options:

- Item Help
- Global Help
- Exit from Help

Item Help

Item Help Buttons appear next to individual fields or objects. Select the button to display a brief message describing the item. Only one help message remains on the screen at a time.

Figure 2.16 Item Help Button



Global Help

The **Global Help** Button appears next to the **Help** Button. If you select the **Global Help** Button, the Page Display Area shows you a description of the current page and all the elements it contains.

Figure 2.17 Global Help Button attached to Help Button

While using Global Help, you also have some additional options:

- The **Global Help** page appears over a ghost image of the screen you were on when you selected global help.

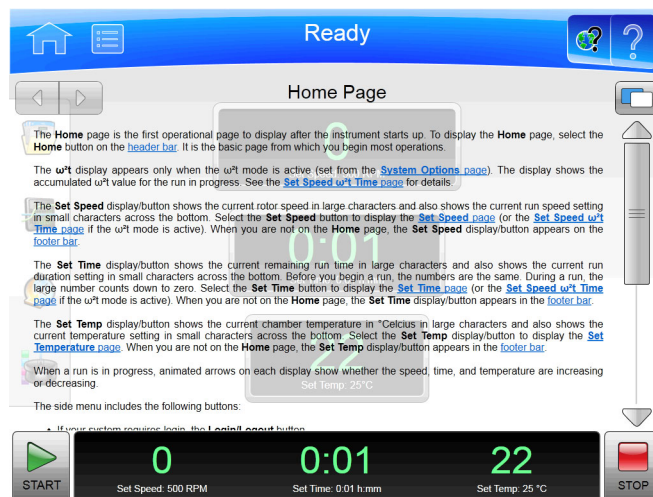
Figure 2.18 Home Page Help with ghost image

If the ghost image makes it difficult for you to read the **Help Page**, select the **Transparency Button** in the upper right corner.

Figure 2.19 Transparency Button

The resulting opaque help page eliminates the image of the screen behind it.

Figure 2.20 Home Page Help with opaque screen

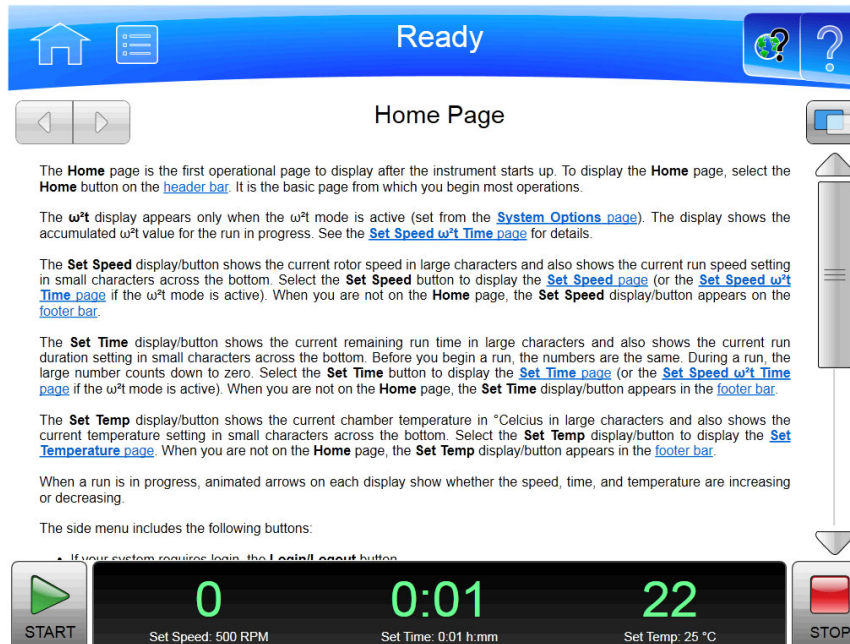

Select the **Transparency** Button again to return to the ghost screen image.

- If you need information about some other aspect of the instrument, you can select the Table of Contents link at the bottom of the page to see the outline of all the available help pages. You have access to all of the help pages from the Table of Contents.

Figure 2.21 Help Navigation Buttons

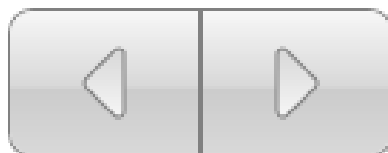

- To navigate through your selected help pages, use the **Forward** and **Back** buttons in the upper left corner.

Exit from Help

Select the **Help** button to exit help mode and return to the previous screen.

About Your Instrument

The system About page contains information about your instrument, including the model number, serial number, and software version, that you need when you call your Beckman Coulter Representative. Follow this procedure to display the [About Page](#).

Figure 2.22 About Page

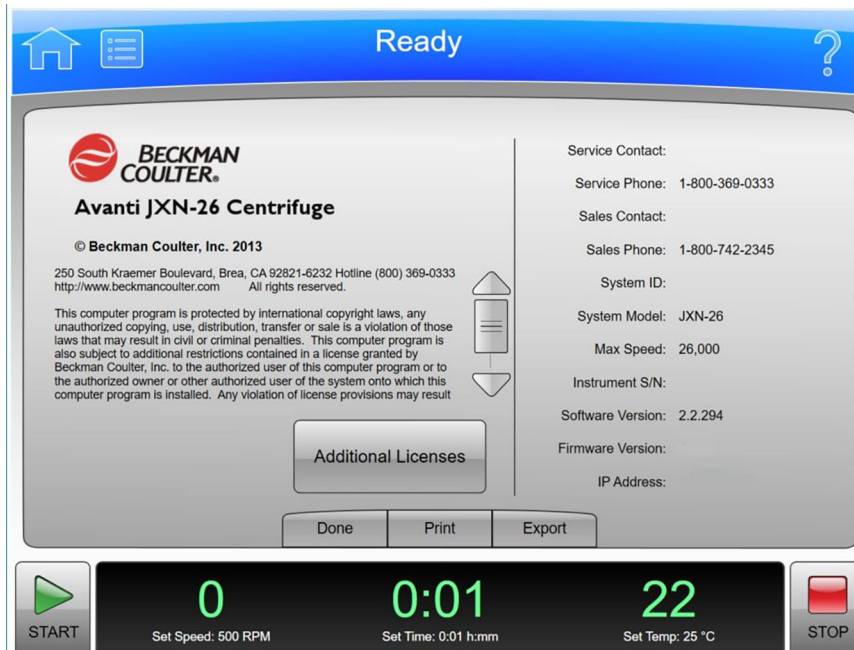

Displaying the About Page

- 1 Select the **Menu** button on the header bar to display the **Menu** page.
- 2 Select the **About** button to display the **About** page.

Overview

The touch screen interface for the Avanti JXN simplifies operations. Although there are many additional things you can do.

This chapter contains information about:

- [Manual Operation](#)
- [Zonal and Continuous Flow Operation](#)

Manual Operation

Manual operation is a simple procedure you can do from the **Home Page**.

Before you begin, you must know:

- Which rotor you are using for the run
- Acceleration and deceleration rate
- Run speed
- Length of time for the run
- Run temperature

NOTE Your system may have additional requirements, depending on your configuration.

When you have this information, the procedure for the run is as follows:

Operating the Run Manually

- 1 Start on the **Home Page**.

- 2 Set the speed and rotor.

- 3 Set the Acceleration and Deceleration profiles.

- 4 Set the time.

- 5 Set the temperature.

6 Start the run.

Step 1: Start on the Home Page

Start at the **Home** Page. If your screen shows any other page, select the **Home Page** Button in the upper left corner of the screen.

Figure 3.1 Home Page



NOTE If your system is in Zonal Mode, you must select the **Cancel** Button to go to the Home Page.

Figure 3.2 Zonal Operation Page with Cancel Button

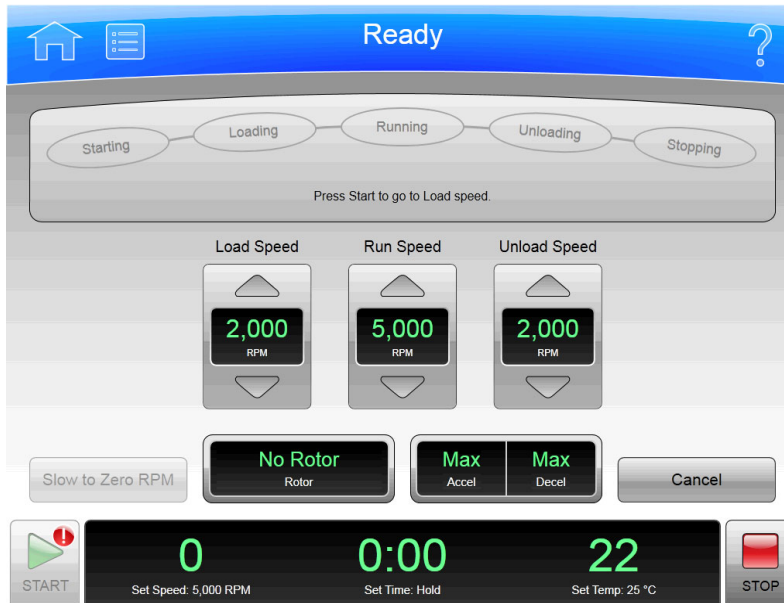

Step 2: Set the Speed and Rotor

Select the **Set Speed** Display/Button on the **Home** Page to go to the **Set Speed** Page.

Figure 3.3 Set Speed Page

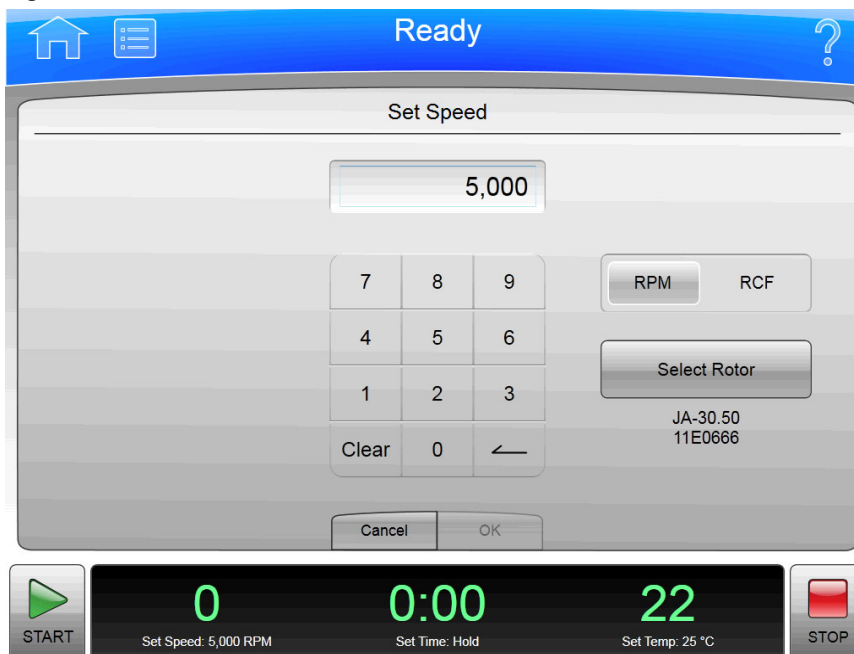

When the **Set Speed** Page appears, follow these steps:

Setting the Speed and Rotor

- 1 Select the **Select Rotor** Button to go to the **Select Rotor** Page.

Figure 3.4 Select Rotor



- 2 Select the rotor for the run from the library. If the desired rotor is not in the library, a system Administrator or Super User must add it.
- 3 Select the **OK** Button to return to the **Set Speed** Page.
- 4 If you plan to set the speed in units of relative centrifugal field (RCF), select the **RPM/RCF** Button. Note that the RPM/RCF button is only enabled when you have selected a rotor.
- 5 Use the keypad to set the desired speed. Note that the speed is set in 10-rpm (or x g when entering RCF) increments, with a zero added to your number. You can also use the **Back** and **Clear** keys to make corrections.
- 6 Select the **OK** key to accept your entry and dismiss the page.

Step 3: Set the Acceleration and Deceleration Profiles

Select the **Accel and Decel Display/Button** to go to the **Set Acceleration/Deceleration Profiles** Page.

Figure 3.5 Set Acceleration/Deceleration Profiles Page



On the **Set Acceleration/Deceleration Profiles** Page, follow these steps:

Setting the Acceleration and Deceleration Profiles

- 1 Select the desired Acceleration and Deceleration profiles.
- 2 Select the **OK** key to accept your entries and dismiss the page.

Step 4: Set the Time

Select the **Set Time** Display/Button to go to the **Set Time** Page.

Figure 3.6 Set Time Page

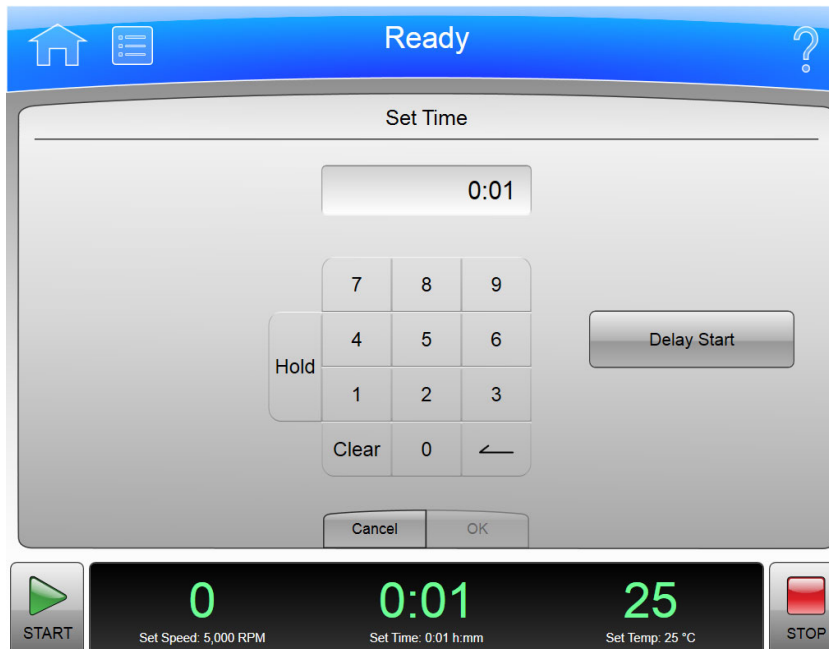

On the **Set Time** Page, follow these steps:

Setting the Time

- 1 Use the keypad to set the desired time in hours and minutes. Use the **Back** and **Clear** keys to make corrections. You can also use the **Hold** key to set the time to a hold state with no countdown to an automatic end. When you select **Hold**, the run does not end until you select the **Stop** key (or until the maximum time of 99 hours and 59 minutes has been reached).

- 2 You can use the **Delay Start** button to set a future start or stop time. Select **Delay Start** to display the Delay Start Page.

Figure 3.7 Delay Start Page



- Select **Start At** or **Stop At** to set a starting or stopping time. Then you can set the date and time in the fields above. Select **OK** to return to the **Set Time** Page.

- 3 Select the **OK** key to accept your entry and dismiss the page.

Step 5: Set the Temperature

Select the **Set Temp** Display/Button to go to the **Set Temperature** Page.

Figure 3.8 Set Temperature Page

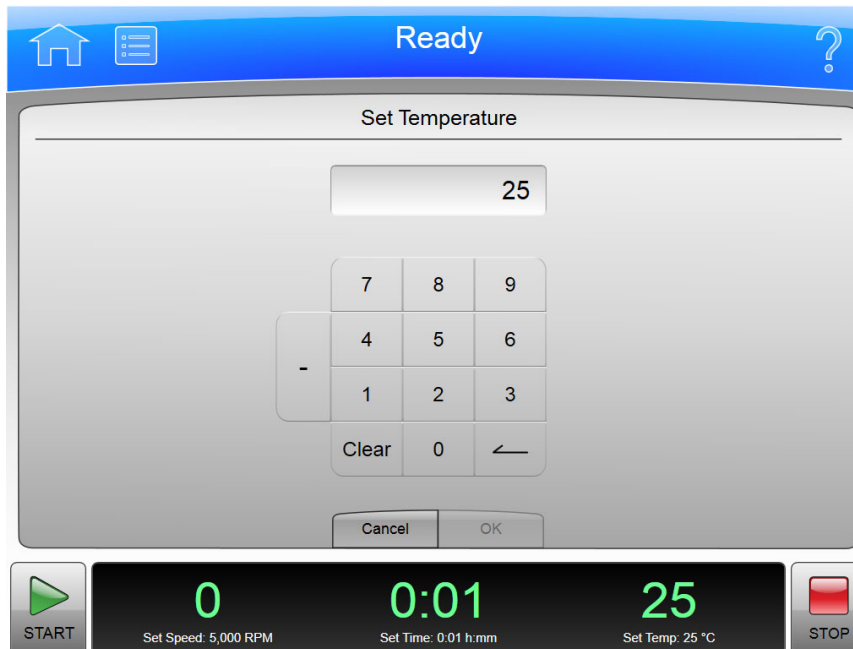

On the **Set Temperature** Page, follow two steps:

Setting the Temperature

- 1 Use the keypad to set the desired temperature in degrees Celsius. Use the **Back** and **Clear** keys to make corrections.
- 2 Select the **OK** key to accept your entry and dismiss the page.

Step 6: Start the Run

Once the run values are set, start the run:

NOTE If you have entered a delayed start, you must select the **Start** button to begin the countdown to the delayed start.

- 1 Prepare your samples and place them in the rotor following all proper procedures, including balanced weight distribution.
- 2 Preheat or precool the rotor and samples, if necessary.

- 3 Mount the rotor in the instrument following all the procedures in the rotor manual and observing all safety procedures and cautions.
- 4 Close the chamber door.
- 5 Select the **Start** button.

Figure 3.9 Start Button



NOTE When the run begins, wait for the countdown timer to reach zero and the rotor to come to a stop. You can then remove your rotor and samples.

Zonal and Continuous Flow Operation

WARNING

Risk of operator injury. In zonal and continuous flow operation, the operator is unavoidably exposed to rotating machinery. For safety, the operator must be properly instructed and qualified. Guard against accidentally dropping objects, such as pens, pencils, or hemostats into the chamber. Loose lab coats, neckties, scarves, and long necklaces should not be worn while operating in the zonal or continuous flow mode.

Use only zonal/continuous flow rotors in the Zonal mode.

Zonal and Continuous Flow operations require special rotors and have some additional hazards in that samples are loaded and unloaded while the rotor is spinning. To prevent unauthorized users from attempting these operations, the instrument requires an authorization code (which is 1793). When Zonal operations are authorized, the system displays the **Zonal Operation** Page. While in Zonal operation, the **Home** Page button displays the Zonal Operation page. The mode does not end until the run is complete or the user selects the **Cancel** Button to end the mode.

Zonal and Continuous Flow operations are very similar. The specific details vary according to the rotor you are using, but the summary below shows an outline of the procedure.

Figure 3.10 Zonal Page



There are seven phases to a Zonal or Continuous Flow run:

- Preparing
- Starting
- Loading
- Running
- Unloading
- Stopping
- Finishing

Each phase is outlined in a section below.

Preparing for the Run

The rotor manual details the preparations for a run, which may include cleaning, assembling, and lubricating the rotor, setting up pumps and tubing, and usually includes overnight cooling to precondition the rotor, sample and solutions used in the run. When you are ready to install the rotor, set the parameters for the run:

- Run Speed
- Run Time
- Temperature
- Load Speed
- Unload Speed

For Continuous Flow operation, you may have two different load speed settings. The initial setting is for alignment and adjustment checks, which you set in this phase.

When everything else is ready, mount the rotor.

Starting the Run

To start the run, select the **Start** Button and wait for the rotor to reach loading speed. The status display at the top of the screen highlights Starting.

For a Continuous Flow run, you need to perform alignment and adjustment checks as detailed in the rotor manual. You may need to use the **Slow to Zero RPM** button to make adjustments and restart with the **Start** Button. Using the **Slow to Zero RPM** button will bring the rotor to a stop, but the instrument will remain in Zonal mode. Refer to [Figure 3.11](#). When the rotor passes the alignment and adjustment checks, set the new loading speed (if it is different from the adjustment speed) and select the **Start** Button again.

Figure 3.11 Zonal Page

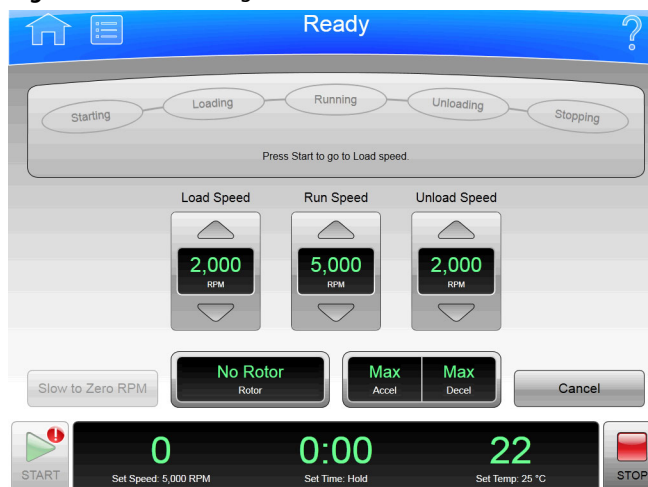

When the rotor reaches the Loading speed, the status display highlights Loading, to show that you have moved into the next phase.

Loading the Sample

In the Loading phase, you inject the sample into the medium in the rotor. Again, the details depend on the rotor and the type of operation as detailed in the rotor manual. When you have finished all the specified loading steps, close the door and select the **To Running** button to go to the next phase.

NOTE While operating in Zonal mode, open-door operation up to 3000 RPM is allowed, but only during the Loading and Unloading steps.

Running the Sample

The instrument highlights Running on the Status Display, accelerates to the set run speed, and begins counting down the set run time. The run phase ends in one of three ways:

- When the timer countdown reaches zero, the instrument decelerates to the unloading speed and goes to the Unloading phase.
- If you select the **To Unloading** Button to terminate the run early, the instrument decelerates to the unloading speed and goes to the Unloading phase.
- If you select the **Stop** Button to abort the run, the instrument brings the rotor to a halt, skips the unloading phase, and exits Zonal mode entirely.

If you need to return to the Loading phase to open the door while the rotor is spinning, press the **To Loading** button and the instrument will slow the rotor to the Load Speed. The instrument will remain in the Loading phase until you select the **To Running** button to return to the Running phase or terminate the run.

Unloading the Sample

While the rotor is running at unload speed, follow the instructions in the rotor manual to inject the displacement solution into the rotor and collect the resulting centrifugate sample.

If you need to return to the Running phase for any reason, press the **To Running** button and the instrument will accelerate the rotor to the Run Speed. The instrument will remain in the Running phase until it is ended in one of the ways discussed in [Running the Sample](#).

Stopping the Run

When you have completed all the defined unloading steps, select the **Stop** Button to bring the rotor to a halt.

Finishing the Run

When the rotor comes to a halt, unmount it and perform all the cleanup and follow-up steps given in the rotor manual. The instrument exits Zonal mode when the rotor comes to a stop.

Overview

The Avanti JXN series includes many options for configuring your system. Some of these options have a significant effect on system functionality, and must be configured before you begin to use the system.

This chapter contains information about:

- [Managing Your Network](#)
- [Managing Users](#)
- [Managing Rotors](#)
- [Managing Reports](#)
- [Managing Qualifications](#)

Managing Your Network

You can add the Avanti JXN series to your network, enabling email, file transfer, and printing to a network printer. You can also enable VNC (Virtual Network Computing) or API (Application Programming Interface) to allow the system to receive instructions from a remote application.

Some features of this instrument can support a GMP workflow with the proper network. Refer to *Optima XPN Series and Avanti JXN Series Recommended Networking Configurations Guide (C67730)* for details. Consult with your local IT department to ensure the privacy and security requirements are met.

Setting Up the Network

- 1 Select the **Menu** button on the Header Bar to display the **Menu** page.
- 2 Select **Options** to display the **System Options** page.
- 3 Select the **Network** Tab, then select **Setup Network** to display the **Setup Network** page.
- 4 **Network path** is the path the instrument automatically uses for import and export. Select the **Network Path** field to display the Network Path page and enter the default path. Select **OK** to return to the Setup Network page.

5 DHCP Mode (Dynamic Host Configuration Protocol) is enabled by default and automatically configures the IP addressing parameters using a DHCP Server on the network.

If your network administrator provides a specific IP address, disable DHCP mode and enter the values provided for the following fields:

- IP Address
- Subnet Mask
- Default Gateway
- DNS Server

To disable DHCP Mode, select **Enable** so that the green square is cleared.

6 Select **Save** to save the network information and return to the **System Options** page.

Selecting a Printer

Use this option to select a USB or network printer for the instrument. The system automatically sends all print requests to the selected printer.

NOTE Printer drivers must be installed by your Beckman Coulter Representative.

1 Select the **Menu** Button on the Header Bar to display the **Menu** page.

2 Select **Options** to display the **System Options** page.

3 Select the **Network** Tab, then select **Select Printer** to display the **Select Printer** page, which lists the available printers.

4 Select a printer from the list. You can select **Test Print** to send a test page to the printer.

5 Select **Save** to save the printer selection and return to the **System Options** page.

Setting Up Email

Use this option to configure email that can be sent from the instrument. The instrument will send diagnostic notifications to the email account of all users with an email address entered in their user profile.

-
- 1 Select the **Menu** button on the Header Bar to display the **Menu** page.

 - 2 Select **Options** to display the **System Options** page.

 - 3 Select the **Network** Tab, then select **Setup Email** to display the **Setup Email** page.

 - 4 Select **SMTP Server** to enter your email server address. Select **OK** to save the address and return to the **Setup Email** page.

 - 5 **Port Number** defaults to 25. Do not change it unless you must use another, specific port number.

 - 6 **User Name** and **Password** are optional, but may be required by your email server. Select the fields to enter the required values, then select **OK** to return to the **Setup Email** page.

 - 7 **Email From** defines the return email address that appears on email notifications sent by the instrument. You can change the default to a legitimate or fictitious address, depending on your requirements. Select the field to enter the new address, then select **OK** to save the address and return to the **Setup Email** page.

 - 8 Select the SSL Server **Enable** button to enable email encryption, if required by your email server. The button displays a green square when the option is enabled.

 - 9 You can select **Test Email** to send an email to test your configuration. Enter the recipient email address and select **OK** to send the email and return to the **Setup Email** page. The system displays a status message for the success or failure sending the test email.

 - 10 When you have completed your configuration, select **Save** to return to the **System Options** page.
-

Setting Up VNC

Use VNC (Virtual Network Computing) to connect to the instrument from a laptop or other remote device.

-
- 1 Select the **Menu** Button on the Header Bar to display the **Menu** page.

- 2 Select **Options** to display the **System Options** page.
- 3 Select the **Network** Tab, then select **Setup VNC** to display the **Setup VNC** page.
- 4 Select the Enable or Disable VNC Server **Enable** button to enable the VNC server. The button displays a green square when the option is enabled.
- 5 To use the PIN of the current user as the VNC password, select the Synchronize VNC Password To Logged in User PIN **Enable** button. To enter a separate VNC password, select **Set Password**. Enter and confirm the password and select **OK** to save and return to the **Setup VNC** page.
- 6 Select **Back** to return to the **System Options** page.

Enabling API

Use this option to allow a remote device to connect to the instrument using the API.

- 1 Select the **Menu** Button on the Header Bar to display the **Menu** page.
- 2 Select **Options** to display the **System Options** page.
- 3 Select the **Network** Tab, then select **Enable API**. The button displays a green square when the option is enabled.
NOTE This button is only active when **Require Login** is enabled and you are logged into the system as an Administrator.
- 4 Select **Done** to return to the **Home** page.

Setting Up a Network

Some features of this instrument can support a GMP workflow. Refer to *Optima XPN Series and Avanti JXN Series Recommended Networking Configurations Guide (C67730)* for details. Consult with your local IT department to ensure that privacy and security requirements are met.

Managing Users

You can require users to log in prior to using the Avanti JXN series. You can use the login to build a run log for each user, and to control access to the system.

The system includes three user levels that grant different ranges of system access.

Table 4.1 User Levels

User Level	Permission
Operator	Can run assigned programs and change user options.
Super User	Can run all programs, run the centrifuge manually, manage users, assign programs, and manage the rotor library.
Administrator	Unlimited access.

Adding Users

- 1 To add users to the system, select the **Menu** Button on the Header Bar to display the **Menu** Page.
- 2 Select **Options** to display the **System Options** Page.
- 3 Select the **Users** Tab, then select **Manage Users** to display the **Manage Users** page.
- 4 Select **Add** to display the **Add User** Page.
- 5 Select the **User ID** field to display the **Edit User ID** Page.
- 6 Use the keypad to enter the new User ID. Select **OK** to return to the **Add User** page.
- 7 Repeat the procedure for the remaining fields. The **PIN** and **Full Name** fields are required.
- 8 Select the User Level. For Operators, you can select the **Authorize Programs** button to add programs to the User. See [Creating Programs](#) in [CHAPTER 5, Programs](#) for more information.
- 9 Select **Save** to add the user to the system and return to the **Manage Users** Page.

You can also use the Manage Users page to edit or delete users, to copy existing user information for a new user, or to edit program permissions for Operator-level users.

Requiring Login

- 1 Select the **Menu** Button on the Header Bar to display the **Menu** Page.
- 2 Select **Options** to display the **System Options** Page.
- 3 Select the **Users** Tab, then select **Require Login**. The button displays a green square when the option is enabled.

PIN Expiration and Logout Timer

The system defaults to expire PINs every 60 days, and to log out users after two minutes of inactivity. Follow these steps to change the defaults.

Changing the Defaults for the PIN Expiration and Logout Timer

- 1 Select the **Menu** Button on the Header Bar to display the **Menu** Page.
- 2 Select **Options** to display the **System Options** Page.
- 3 Select the **Users** Tab.
- 4 To change the PIN expiration, select the **PIN Expiration** button.
- 5 Select **Clear** to clear the field. Enter the number of days that you want PINs to remain valid. To disable PIN Expiration, enter 0.
- 6 Select **OK** to return to the **Users** Tab.
- 7 To change the logout time, select the **Logout Timer** button.
- 8 Change the field to the number of minutes of inactivity before the system logs out a user. To disable the Logout Timer, enter 0.

-
- 9 Select **OK** to return to the **Users Tab**.
-

User Options

When Login is required, the User Options page becomes active. From this page, users can change their PIN, add or change their email and phone number, and select an avatar and background to appear on their Home page.

Changing User Options

- 1 Select the **Menu** button on the Header Bar to display the **Menu** page.
-
- 2 Select **Options** to display the **System Options** page.
-
- 3 Select the **Basic** Tab, then select **User Options**. The system displays the **User Options** page for the user that is currently logged in.
-
- 4 To change the PIN, select the **PIN** field to display the **Reset User PIN** page.
 - Use the keypad to enter the current PIN, and confirm the new PIN.
 - Select **Save** to change the PIN and return to the **User Options** Page.
-
- 5 To add or change the email or phone number, select the **Email** or **Phone** field to display the **Edit Email** or **Edit Phone** page.
 - Use the keypad to update the field.
 - Select **Save** to save your changes and return to the **User Options** Page.
-
- 6 To select or change the avatar or background, select **Set Avatar** or **Set Background** to display the **Select Image** Page.
 - Select an image from the available images on the left, or select **Import Image** to import an image from a USB device or network location.
 - Select **Save** to set the image and return to the **User Options** Page.
-
- 7 Select **Done** to return to the **System Options** page.
-

Managing Rotors

When you enter a manual run, you must record the rotor that you are using. Once a rotor is selected, you can track rotor usage and convert from RPM to RCF.

To make rotors available for selection, you must add rotors to the rotor library.

Adding Rotors

- 1 To add rotors to the rotor library, select the **Menu** button on the Header Bar to display the **Menu** page.
- 2 Select **Options** to display the **System Options** page.
- 3 Select the **System** Tab, then select **Manage Rotors** to display the **Manage Rotors** page.
- 4 Select **Add** to display the **Add to Rotor Library** page.
- 5 Select a type of rotor from the list on the left.
- 6 You must enter a serial number for the rotor. Select the **Serial Number** field to display the **Serial Number** Page. Enter the serial number and select **OK** to return to the **Add to Rotor Library** page.
- 7 If you want to enter an existing run count, repeat the procedure for the **Run Count** field. The run count will increment automatically as the rotor is used.
- 8 Select **Save** to add the rotor to the Rotor Library and return to the **Manage Rotors** Page.

NOTE You can also use the Manage Rotors page to delete rotors from the library.

Managing Reports

The Avanti JXN series automatically saves run history data associated with each run. The run history generated includes:

Figure 4.1 Run History (Filtered View)

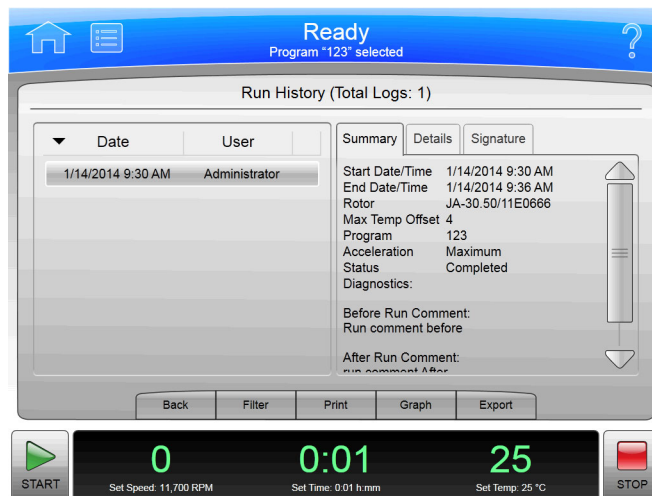

- User information
- Start date and time of the run
- End date and time of the run
- Rotor type
- Program name
- Acceleration and Deceleration parameters
- Before Run Comment
- After Run Comment
- Detailed information about each step in a run
- Graph of the run
- Most recent Installation Qualification, Operational Qualification, and Performance Qualification dates
- Optional E-Signatures

User Access

- An Operator-level user can manually filter data, graph data, and print data for a run.
- A Super User-level user can also export run history data to an external media source, such as a USB drive or network location.
- An Administrator-level user can also configure the Avanti JXN series to automatically print and/or export run history data.

Filtering Data

You can filter run history data before you graph or print it.

- 1 On the **Home** page, select the **Run History** button on the side menu.

Figure 4.2 Run History Button



- 2 On the **Run History** page, select the **Filter** tab at the bottom of the screen.

- 3 On the **Run History Filter** page, select the **Filter by User** button and choose from the options below.

Figure 4.3 Run History Filter

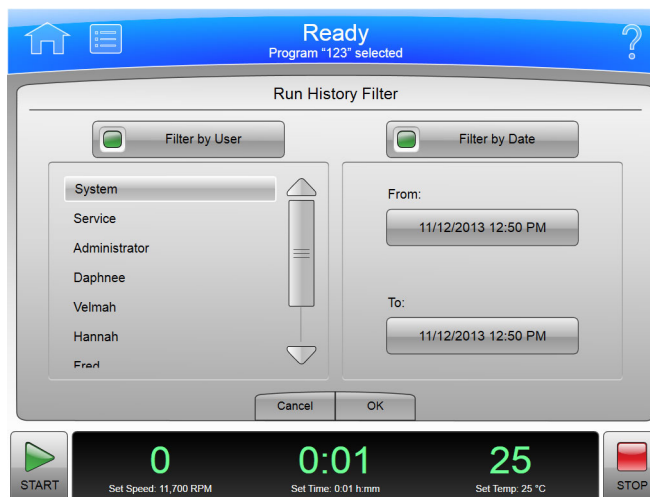

- 4 Select the **Filter by Date** button, then select the **From** button.

Figure 4.4 Set From Date and Time

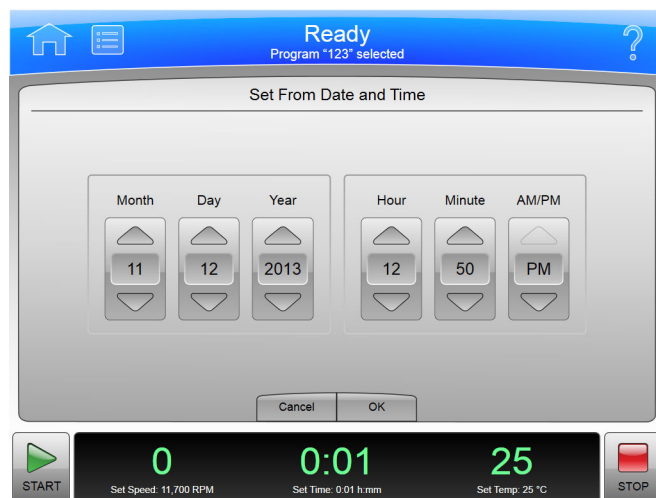

- 5 On the **Set From Date and Time** page, use the up and down arrow buttons to set the parameters for the Month, Day, Year, Hour, Minute, and AM/PM. Then select **OK** to return to the **Run History Filter** page.
- 6 Select the **To** button under Filter by Date.
- 7 On the **Set To Date and Time** page, again use the up and down arrow buttons to set the parameters for Month, Day, Year, Hour, Minute, and AM/PM (depending on selected time format). Then select **OK** to return to the **Run History Filter** page.
- 8 On the **Run History Filter** page, select **OK** to return to the **Run History** page.
You can now Print, Graph or Export the filtered run history.

Graphing Data

To graph data for a run in progress:

Graphing Data for a Run in Progress

- 1 Select the **Run Graph** button on the side menu of the **Home** page.

Figure 4.5 Run Graph Button



- 2 On the **Real-Time Run Data** page, select **Options**.
-

- 3 On the **Run Graph Options** page, select one of three options under Run Graph View Scope: **Fit To Screen**, **Auto Scroll**, or **Manual Scroll**. The default is **Fit To Screen**. Then select **OK**.
-

Graphing Data for a Previously Completed Run

- 1 Select the **Run History** button on the side menu of the **Home** page.

Figure 4.6 Run History Button



- 2 On the **Run History** page, select the Date of the run from the left column.
-

- 3 Select the **Graph** tab at the bottom of the page.
-

- 4 On the **Historical Run Data** page, select **Options**.

- 5 On the **Run Graph Options** page, choose one of three options: **Fit To Screen**, **Auto Scroll**, or **Manual Scroll**. (**Fit To Screen** is the default.) Then select **OK**.

Figure 4.7 Run Graph Options

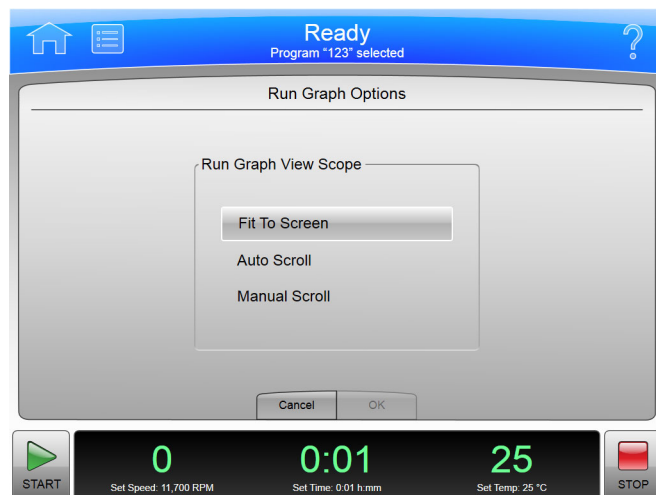

Print Data

You can print run history from the Run Graph page or the Run History page.

NOTE You must have Administrator access to configure the printer.

Printing Run History from the Run Graph Page

- 1 After the run is completed, select the **Run Graph** button from the side menu on the **Home** page.

Figure 4.8 Run Graph Button



- 2 On the **Real-Time Run Data** page, select the **Options** tab.
- 3 On the **Run Graph Options** page, choose one of three options: **Fit To Screen**, **Auto Scroll**, or **Manual Scroll**. (**Fit To Screen** is the default.) Then select **OK**.

- 4 Select the **Print** button. The system sends the run graph to the printer configured by the Administrator.

Printing Run History from the Run History Page

- 1 Select the **Run History** button from the side menu of the **Home** page.

Figure 4.9 Run History Button



- 2 Use filtering to display the run histories you want to print.
- 3 Select the **Print** button. The system sends the run history for all currently listed runs to the printer configured by the Administrator.

Export Data

Run history data can be manually exported to an external media source, such as a USB drive, or automatically exported to a network. Run history reports are generated in pdf and xml formats, while run history data is in csv format.

NOTE You must have Administrator access to configure the network to automatically export data.

Manually Exporting Run History Data to a USB Drive

IMPORTANT Before manually exporting, use the Setup Network page to configure network settings. See [Setting Up the Network](#) for more information.

- 1 Select the **Run History** button on the side menu of the **Home** page.

Figure 4.10 Run History Button



- 2 On the **Run History** page, use filtering to display the run histories you want to export, then select the **Export** button.

Figure 4.11 Run History

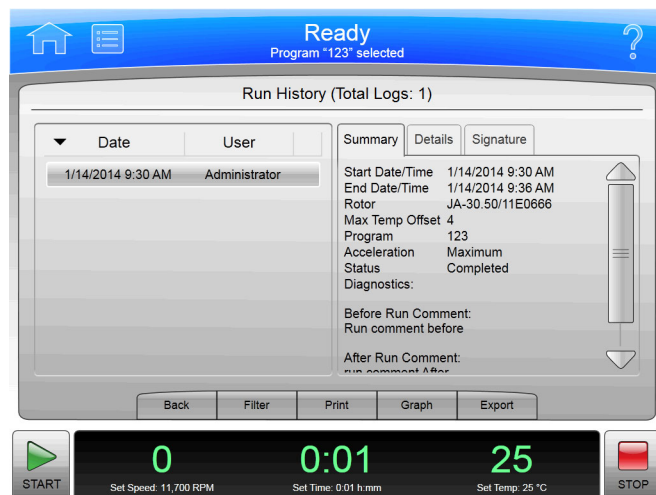

- 3 On the **Export Run History** page, the system displays a prompt to insert the USB drive.
- 4 When the system reads the USB drive, select it from the Available Drives list, and select the **Export** button.
The Avanti JXN series will then export the currently listed run histories to the USB drive.

Manually Exporting Run History Data to a Mapped Network

IMPORTANT Before manually exporting, use the Setup Network page to configure network settings. See [Setting Up the Network](#) for more information.

- 1 Select the **Run History** button on the side menu of the **Home** page.

Figure 4.12 Run History Button



- 2 On the **Run History** page, use filtering to display the run histories you want to export, then select the **Export** button.

-
- 3 On the **Export Run History** page, select the network from the Available Drives list, then select the **Export** button.
-

Auto Print and Auto Export Run History Data

A user with Administrator access can configure the Avanti JXN series to automatically print run history data. The Avanti JXN series can also be configured to automatically export run history data to a previously configured network. Run history data automatically sent to a network is generated as a .csv file (a simple spreadsheet format) and an .xml file (a simple, structured text format).

IMPORTANT Before you enable Auto Export, check with your network administrator to make sure you have write permission to a folder where the automatically exported run history data can be stored.

Enabling Auto Print

- 1 Select the **Menu** button on the Header Bar to display the **Menu** page.
 - 2 Select the **Options** button.
 - 3 Select the **Reports** tab.
 - 4 Select the **Auto Print** button.
The small box in the **Auto Print** button will turn green to indicate it is enabled.
When a run is completed, the Avanti JXN series will automatically print the run history data to the printer previously configured to the program.
 - 5 To deactivate the **Auto Print** function, follow the previous four steps.
The small box in the **Auto Print** button will turn grey to indicate it is disabled.
-

Enabling Auto Export

IMPORTANT Before you enable Auto Export, use the Setup Network page to configure network settings. See [Setting Up the Network](#) for more information.

- 1 Select the **Menu** button on the Header Bar to display the **Menu** page.

2 Select the **Options** button.

3 Select the **Reports** tab.

4 Select the **Auto Export** button.

The small box in the **Auto Export** button will turn green to indicate it is enabled.

When a run is completed, the instrument automatically exports the run history data to the network (if previously configured) as a .csv file (a simple text spreadsheet) and an .xml file (a simple, structured text format).

5 To deactivate the Auto Export function, follow the previous four steps.

The small box in the **Auto Export** button will turn grey to indicate it is disabled.

Enabling Run Comments

The Run Comments function enables the user to add comments to the run log before and after the end of a run.

1 On the **Home** page, click on **Menu** icon.

2 Select **Options**.

3 Select the **Reports** tab.

4 Select the **Run Comments** button.

The small box in the **Run Comments** button will turn green to indicate it is enabled.

5 To deactivate the Run Comments function, follow the previous four steps.

The small box in the **Run Comments** button will turn grey to indicate it is disabled.

Using Run Comments

1 Select the **Start** button to begin a run.

- The system displays the **Before Run Comment** page. Enter a comment and select **OK** to start the run. You can leave the comment field blank, but you must select **OK** to start the run. If you select **Cancel**, the run will not start.

Figure 4.13 Before Run Comment

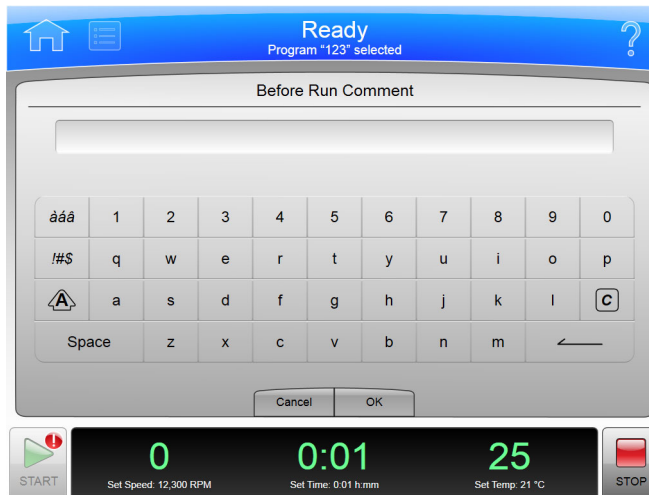

- When the run stops or you select the **Stop** button, the system displays the **After Run Comment** page. Enter a comment, and select **OK**.
The comments appear in the **Summary** tab of the **Run History** page.

Signature Options

Manual Signature or E-Signature lines can be added to run history reports to support a GMP workflow. The E-Signature function permits a user to electronically add a signature and add a note (if desired) to run history data after the run is complete.

NOTE You must have Administrator access to select signature options. **Require Login** must be enabled to select a signature option.

To Select a Signature Option:

- On the **Home** page, select the **Menu** button.
- Select the **Options** button.
- Select the **Reports** tab.

-
- 4 Select the **Signature** drop down box.
Options for **Manual signatures**, **E-signature**, or **No Signature** are available.
-
- 5 Select **Signature** lines to include in reports.
 - a. If you select **No Signature**, **No Signature** line will be included in each run history.
 - b. If you select **Manual Signature**, you can select the Signatures (Author, Reviewer, Approver) you wish to include in each run history.
 - c. If you select **E-Signature**, the current user ID can be manually added (Author, Reviewer, Approver) to each run history.
 - d. If you export a run history report, **Manual Signature** or **E-Signature** lines, if selected, will be included in the report.
 - e. Run history reports will include existing E-Signatures, even if E-Signatures are not selected at the time of export.
-

Using E-Signature

- 1 After a run is complete, select the **Run History** button on the side menu of the Home page.
-
- 2 On the **Run History** page, select the run to which comments will be added.
-
- 3 Select the **Signature** tab.
-
- 4 In the **Sign As** box, select Author, Reviewer, or Approver.

NOTE You can select the Author option only if you started the run. You must have Super User or Administrator access to select Reviewer or Approver.

Figure 4.14 Signature

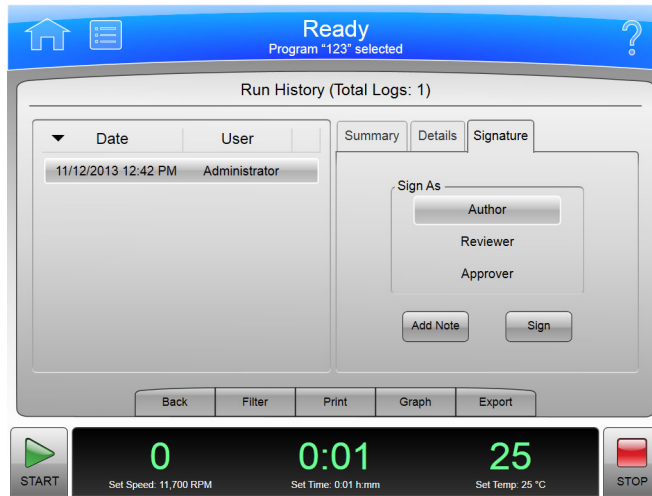

- 5 Select **Sign** or **Add Note**.
 - a. If you select **Sign**, the system displays the **Sign** page. Enter your PIN and select **OK**.
The system adds the E-Signature to the Summary on the **Run History** Page. See the [Run History Page](#) for more information.
 - b. If you select **Add Note**, the system displays the **Add Note** page. Enter the note, then select **Sign**. The system displays the **Sign** page. Enter your PIN and select **OK**.
The note and E-Signature will be added to the Summary on the **Run History** page. See the [Run History Page](#) for more information.

Managing Qualifications

Figure 4.15 System Option, Qualification

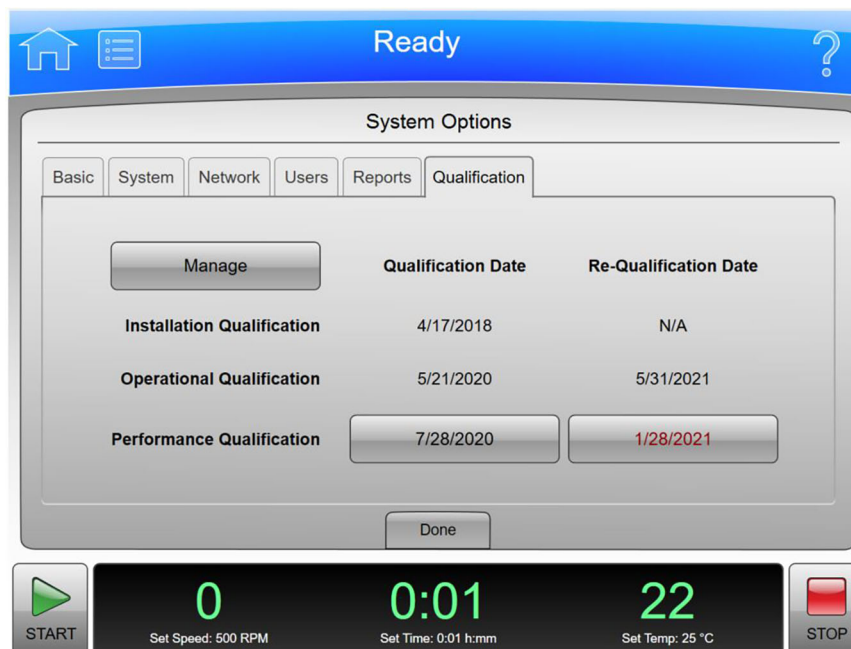

Avanti JXN can provide instrument qualification status and the ability to enable a qualification alert.

- Installation Qualification (IQ) - Qualification at installation performed by a BCI Service Technician.
- Operational Qualification (OQ) - Certified qualification performed at either 6 or 12 month interval by a BCI Service Technician. [Contact Us](#)
- Performance Qualification (PQ) - Workflow verification performed by a user lab at a user-selected interval.

NOTE You must have Administrator access to enter PQ dates and enable the qualification alert.

- 1 On the Home page, select the **Menu** button.
- 2 Select the **Options** button.
- 3 Select the **Qualifications** tab.
- 4 Select the **Performance Qualification** button to enter the initial qualification date and time.
- 5 Select the **Performance Re-Qualification** button to enter the re-qualification date and time.

Figure 4.16 Qualification Management

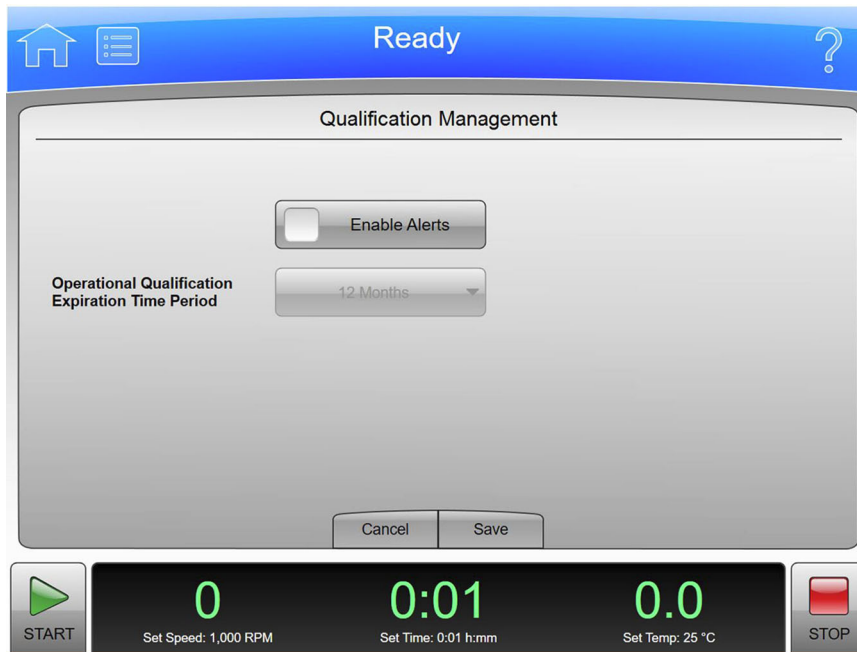

6 Select the **Manage** button to display the Qualification Management page. Select the **Enable Alerts** button. The small box in the **Enable Alerts** button will turn green to indicate that it is enabled. A **Qualification Alert** icon will be displayed at the top of the screen within 30 days of the re-qualification date and will continue to be displayed after the date. The instrument continues to function normally when the **Alert** icon is displayed. Selecting the **Alert** icon will immediately open the **Qualification** tab.

7 Select the desired Operational Qualification Time Interval.

Overview

The Avanti JXN series includes the functionality to create and store programs in the centrifuge memory. A program is a series of steps containing parameters for a run. Programs are retained in the centrifuge memory until they are deleted.

This chapter contains information about:

- [Creating Programs](#)
- [Running Programs](#)
- [Editing Programs](#)
- [Deleting Programs](#)

Creating Programs

Creating Programs

- 1 Select **Program** from the side menu on the **Home** page.

NOTE When Require Login is enabled, programs can only be created by an Administrator or Super User.

Figure 5.1 Program Button

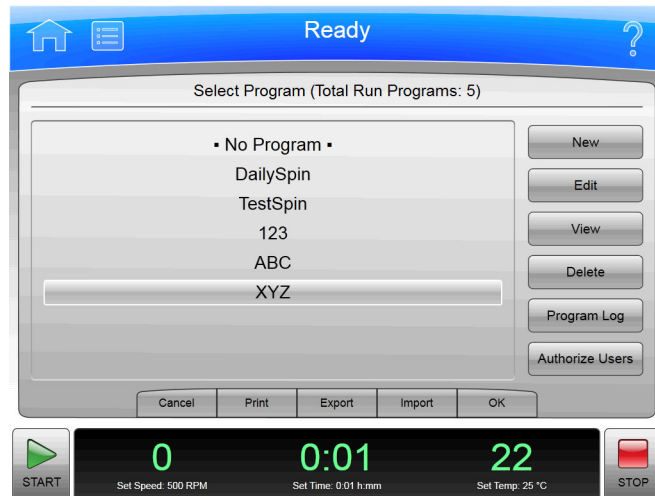

Figure 5.2 Home



- 2 On the **Select Program** page, select the **New** button.

Figure 5.3 Select Program



- 3 On the **New Program** page, **•Unnamed•** appears as the title. To name the new program now, select **•Unnamed•** on the screen.

Figure 5.4 Unnamed program

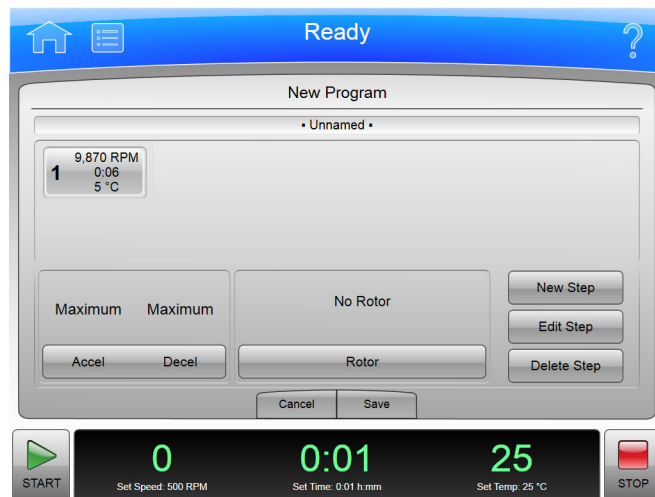

- 4 On the **New Program Name** page, use the keyboard to name it, then select **OK** to save it.

NOTE Program names cannot be reused.

Figure 5.5 New Program Name

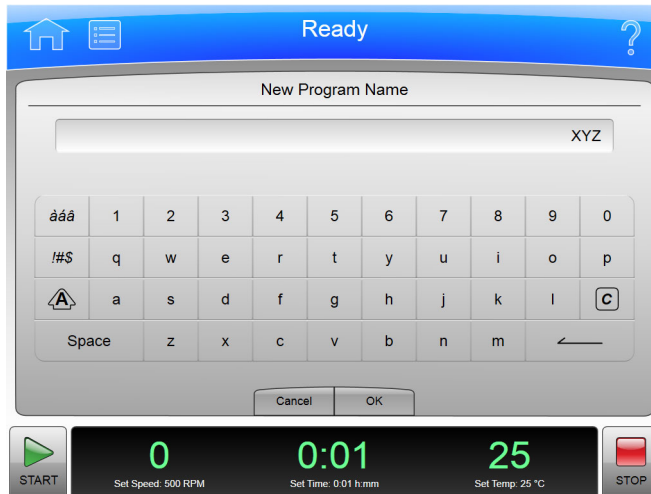

- 5 On the **New Program** page, select the **Accel Decel** button to set the Acceleration and Deceleration profiles. On the **Acceleration/Deceleration Profiles** page, set the profiles, then select **OK** to save them and return to the previous page.

Figure 5.6 Set Acceleration/Deceleration Profiles



- To specify the rotor, select the **Rotor** button. The system displays rotor types. Select a rotor. When you are finished making your selection, select **OK** to save them and return to the previous page.

NOTE Specifying a rotor type is optional. However, if a rotor type is selected within the program editor, this constrains the other program settings and the rotor instance selected for the run.

Figure 5.7 Select Rotor

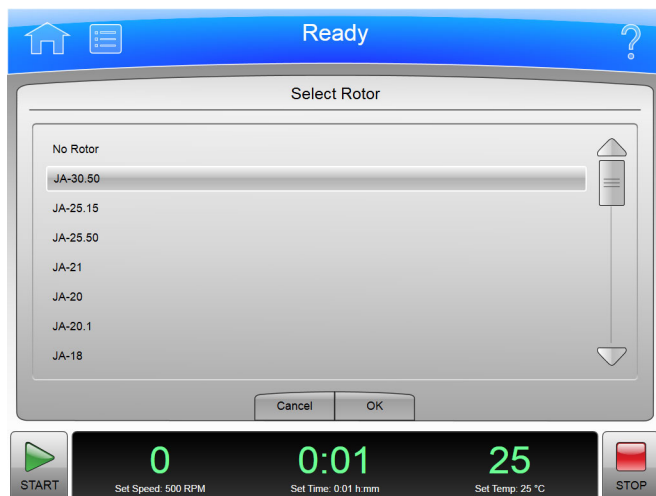

- On the **New Program** page, select the **New Step** button.

Figure 5.8 New Step

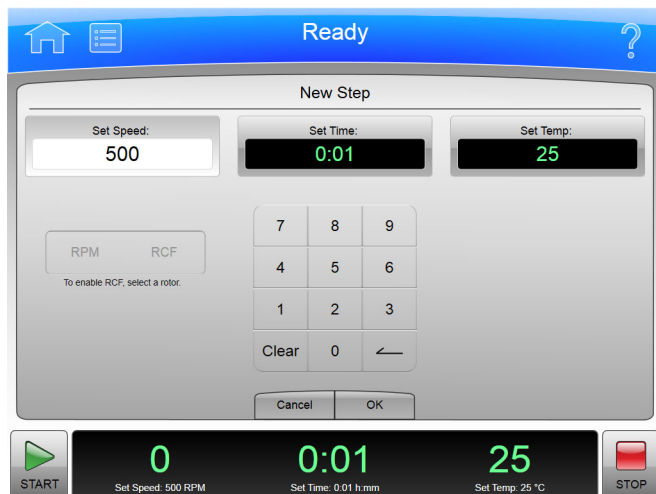

- a. Select the **Set Speed** button at the top of the page, then use the keypad to set the speed. The speed must be at least 500 RPM up to the maximum speed for the selected rotor. If you plan to set the speed in units of relative centrifugal field (RCF), select the **RPM/RCF** button.

NOTE The **RPM/RCF** button is only enabled when you have selected a rotor.

- b. Select the **Set Time** button, then use the keypad to set the time range. The run time must be between 1 minute and 99 hours 59 minutes.
- c. Select the **Set Temp** button, then use the keypad to set the temperature.
- d. When the parameters for Speed, Time, and Temperature are set, select **OK** to save the step and return to the **New Program** page.

- 8 The new step appears in a numbered sequence for the run. From this point, more steps can be added to the run, edited, or deleted using the **New Step**, **Edit Step**, and **Delete Step** buttons.

Figure 5.9 New Step in a numbered sequence

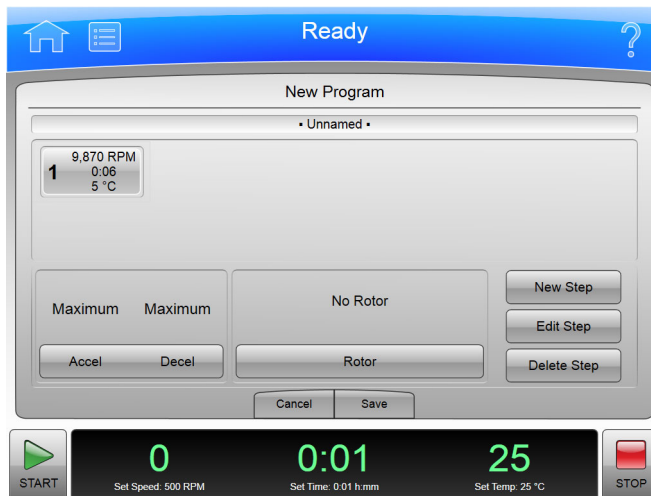

- 9 Select **Save** to store the program.

Running Programs

NOTE If **Require Login** is enabled, the user needs to be authorized to run the programs. Users will only be able to see the programs they are authorized to run.

Running Programs

- 1 Select **Program** from the side menu on the **Home** page.

Figure 5.10 Program Button



- 2 On the **Select Program** page, choose the program you want to run, then select **OK**.

NOTE The list will only show the programs that are authorized for use by the user.

- 3 Select the **Start** button. The run program begins.

NOTE You must select a compatible rotor from the Rotor Library in order to enable the **Start** button. If the program specifies a rotor type, that further constrains the set of valid rotors you can choose from.

NOTE You must have Super User or Administrator access to change a run in progress. If you select the Set Speed, Set Time, or Set Temp buttons to change the parameters while a program is running, the system displays a message that you cannot change parameter values for the selected program. It will ask if you want to exit the program and run with the changes, in which case, the remaining steps in the program will NOT be run.

- 4 To stop the run for any reason, select the **Stop** button.
-

Editing Programs

You must have Administrator or Super User access to modify any part of a program, which includes the Steps, Acceleration/Deceleration rates, and Rotor. You can edit a program only when it is not running.

Editing a Program

- 1 Select **Program** from the side menu on the **Home** page.

Figure 5.11 Program Button



- 2 Select the program you want to edit and select the **Edit** button. If the program is selected to run, that selection will be cleared. If the program is running, the **Edit** button will be disabled.
- 3 On the **Edit Program** page, select the numbered step you want to edit, then select the **Edit Step** button.
- 4 On the **Edit Step** page, select each button you want to modify (**Set Speed**, **Set Time**, and **Set Temp**), then select the **Clear** button and enter the new parameters. Select **OK** to save the changes and return to the previous page.
- 5 On the **Edit Program** page, you can select the **Accel Decel** button and/or the **Rotor** button, and modify each set of parameters. Then select **Save**.

Deleting Programs

You can delete any program that is not currently running.

NOTE If **Require Login** is enabled, only an Administrator or Super User may delete a program.

- 1 On the **Home** page, select **Program** from the side menu.

Figure 5.12 Program Button



- 2 On the **Select Program** page, select the program you want to delete, then select the **Delete** button.
- 3 The system displays a confirmation message. Select **Yes** to delete the program, or select **No** to cancel the deletion.

NOTE A deleted program name cannot be reused.

Overview

This chapter describes the functional pages used to control the Avanti JXN series. They include all of the following:

- Home Page
- Home Page (Run in Progress)
- Set Speed Page
- Select Rotor Page (Library)
- Set Time Page
- Delay Start Page
- Set Speed ω^2t Time Page
- Set Temperature Page
- Set Acceleration/Deceleration Profiles Page
- Login Page
- Select Program Page
- New/Edit/View Program Page
- Select Rotor Page (Catalog)
- New/Edit Step Page
- Program Log Page
- Export Page
- Authorize Users Page
- Import Page
- Real-Time Run Data/Historical Run Data Page
- Run Graph Options Page
- Run History Page
- Run History Filter Page
- Before Run/After Run Comment Page
- Menu Page
- System Options Page
- Select Language Page
- User Options Page
- Max Temperature Offset Page
- Reset User PIN Page

- [Select Image Page](#)
- [Set Date and Time Page](#)
- [System Log Page](#)
- [Manage Rotors Page](#)
- [Add to Rotor Library Page](#)
- [Diagnostic History Page](#)
- [Set Sound Page](#)
- [Custom Sounds Page](#)
- [Archive Data Page](#)
- [Setup Network Page](#)
- [Select Printer Page](#)
- [Setup Email Page](#)
- [Setup VNC Page](#)
- [Manage Users Page](#)
- [Add/Edit User Page](#)
- [Authorize Programs Page](#)
- [Rotor Catalog Page](#)
- [About Page](#)
- [Zonal Authorization Page](#)
- [Zonal Operation Page](#)

Home Page

Figure 6.1 Home Page



The **Home** page is the first operational page to appear after the instrument startup. To display the Home page, select the **Home** page button on the Header Bar. It is the basic page from which you begin most operations. The large fields are designed for viewing from a distance.

You can select the **Home** page button to return to the Home page.

In addition to the Header Bar and the Footer Bar, the **Home** page contains the following elements:

- The **ω^2t** Display.
The **ω^2t** Display appears only when you have enabled **ω^2t** mode on the [System Options Page](#). It shows the accumulated **ω^2t** value for the run in progress. See the [Set Speed \$\omega^2t\$ Time Page](#) for details.
- The **Set Speed** Display/Button.
The **Set Speed** Display/Button shows the current rotor speed as a large number and also shows the current run speed setting in small characters across the bottom. Select the **Set Speed** Display/Button to display the [Set Speed Page](#) (or the [Set Speed \$\omega^2t\$ Time Page](#) if the **ω^2t** mode is active). When you are not on the **Home** page, the **Set Speed** Display/Button appears in the Footer Bar.
- The **Set Time** Display/Button.
The **Set Time** Display/Button shows the current remaining run time as a large number and also shows the current run duration setting in small characters across the bottom. Before you begin a run, the numbers are the same. During a run, the large number counts down to zero.

NOTE In Hold mode, the time counts up to show the length of time the instrument has been running, and continues to increment until you select Stop or the maximum run time elapses. When a delayed run is scheduled or pending, the time counts down to the effective start time of the run.

Select the **Set Time** Display/Button to display the [Set Time Page](#) ([Set Speed \$\omega^2\$ t Time Page](#) if the ω^2 t mode is active). When you are not on the **Home** page, the **Set Time** Display/Button appears in the Footer Bar.

- The **Set Temp** Display/Button.

The **Set Temp** Display/Button shows the current temperature as a large number and also shows the current temperature setting in small characters across the bottom. Select the **Set Temp** Display/Button to display the [Set Temperature Page](#). When you are not on the **Home** page, the **Set Temp** Display/Button appears in the Footer Bar.

- The Side Menu

The Side Menu must be accessed from the **Home** page, and includes the following buttons:

- If your system requires login, the **Login/Logout** button. Select this button to log in or out of the system.
- The **Program** button. Select this button to display the [Select Program Page](#).
- The **Run Graph** button. Select this button to display the [Real-Time Run Data/Historical Run Data Page](#).
- The **Run History** button. Select this button to display the [Run History Page](#).
- The **Zonal Mode** button. Select this button to display the [Zonal Authorization Page](#).

- The **Rotor** Display/Button

The **Rotor** Display/Button on the Footer Bar shows the current selected rotor. Select this button to display the [Select Rotor Page \(Library\)](#).

IMPORTANT Zonal mode is used when the JCF-Z continuous flow/zonal rotor is installed.

When you use Zonal mode, the [Zonal Operation Page](#) replaces the **Home** page.

Home Page (Run in Progress)

Figure 6.2 Home Page (Run in Progress)



When an actual run is in progress, the **Home** page includes the following information:

- The **Set Speed** Display shows the actual speed of the rotor in RPM or RCF.
- The **Set Time** Display shows the time remaining in the run or the present step of the run program. If the time setting is Hold, it displays the actual run time elapsed.
- The **Set Temp** Display shows the current actual temperature of the run in degrees Celsius.

Animated arrows on each display show whether the speed, time and temperature are increasing or decreasing.

Set Speed Page

Figure 6.3 Set Speed Page (Rotor Selected)

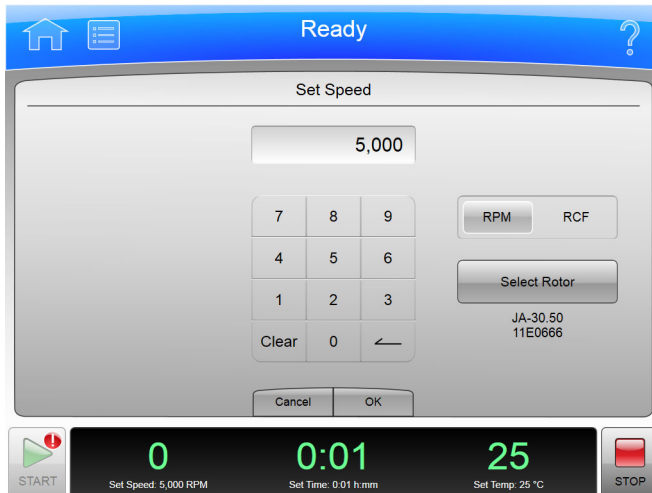

To set the speed for the next run or change the speed of the run in progress, select the **Set Speed** Display/Button on the [Home Page](#) or the Footer Bar to display the **Set Speed** page. You can select the **RPM RCF** button to set the value in RCF (Relative Centrifugal Field) instead of RPM.

If the instrument is in ω^2t mode, the system displays the [Set Speed \$\omega^2t\$ Time Page](#).

In addition to the Header Bar and the Footer Bar, the **Set Speed** page contains the following elements:

- The Set Speed Display at the top of the page shows the current Set Speed in RPM or RCF. The last digit is always zero.
- The keypad changes the speed setting. You can use the **Clear** and **Back** keys to make corrections.
- The **RPM/RCF** button selects the speed units. This button is disabled until a rotor is selected.
- The **Select Rotor** button displays the [Select Rotor Page \(Library\)](#) page.
- The **Cancel** button discards your changes and dismisses the page.
- The **OK** button saves your entry and dismisses the page.

Select Rotor Page (Library)

Figure 6.4 Select Rotor Page (Library)

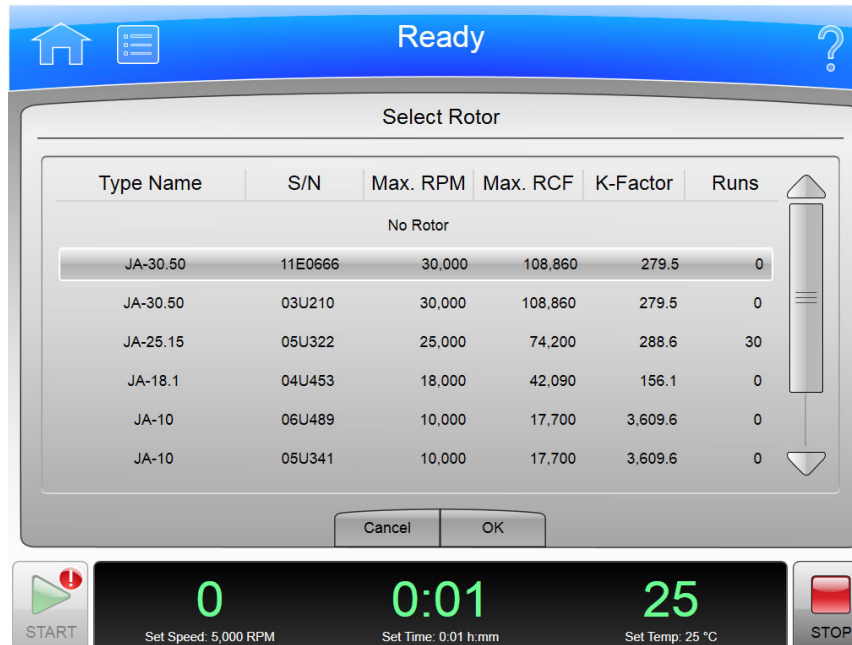

To select a rotor for the next run, select the **Rotor Display/Button** on the Home Page or the **Select Rotor** button on either the [Set Speed Page](#) or the [Set Speed \$\omega\$ t Time Page](#) to display the **Select Rotor** page. This page displays the library of rotors that have been entered for your instrument.

In addition to the Header Bar and the Footer Bar, the **Select Rotor** page contains the following elements:

- The Rotor Library List shows the available rotors for the instrument. Select a rotor from this list. You must select a rotor before you can start a run.
- The **Cancel** button cancels your selection and dismisses the page.
- The **OK** button saves the selection and dismisses the page.

For details about each rotor, see the [Rotor Catalog Page](#).

Set Time Page

Figure 6.5 Set Time Page

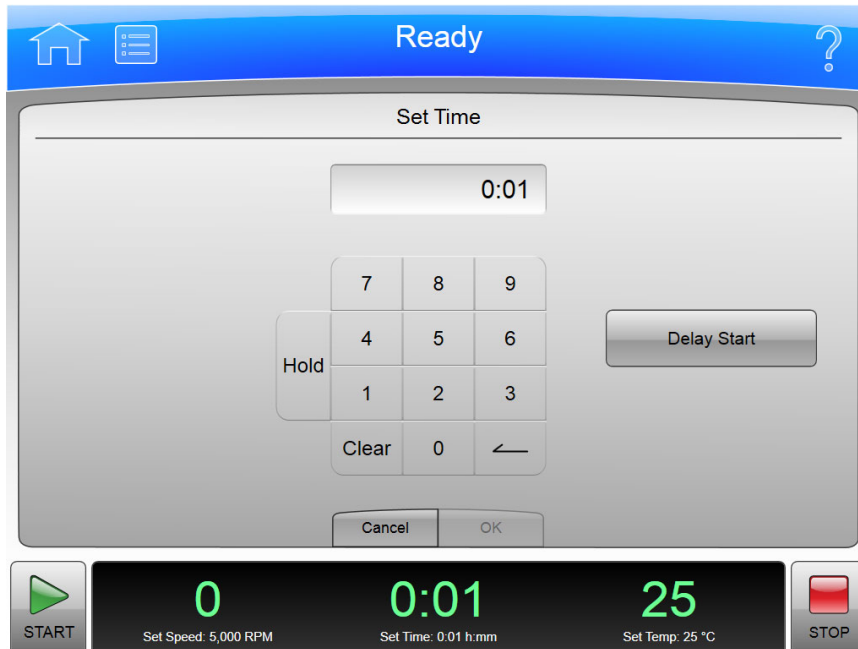

To set the duration for the next run or change the duration of the run in progress, select the **Set Time** Display/Button on the [Home Page](#) or the Footer Bar to display the **Set Time** page.

If the instrument is in ω^2t mode, the [Set Speed \$\omega^2t\$ Time Page](#) appears instead.

In addition to the Header Bar and the Footer Bar, the **Set Time** page contains the following elements:

- The Set Time Display shows the current **Set Time** setting in hours and minutes.
- The keypad changes the time setting. You can use the **Clear** and **Back** keys to make corrections.
- The **Hold** key sets the time to a hold state with no countdown to an automatic end. When you select **Hold**, the run does not end until you select **Stop** (or until the maximum time of 99 hours and 59 minutes has elapsed).
- The **Delay Start** button displays the [Delay Start Page](#), to set a future time at which to start or end the run. This button is disabled when a run is in progress or a delayed run is pending. (To stop the countdown on a pending delayed run, go to the [Delay Start Page](#) and select **No Delay**.)
- The **Cancel** button discards your entry and dismisses the page.
- The **OK** button accepts your entry and dismisses the page.

Delay Start Page

Figure 6.6 Delay Start Page



To set a future start or end time for the next run, select the **Delay Start** button on the [Set Time Page](#) or the [Set Speed with Time Page](#) to display the **Delay Start** page.

In addition to the Header Bar and the Footer Bar, the **Delay Start** page contains the following elements:

- The current time in hours and minutes and the length of time currently set for the run.
- The **No Delay** button (default) sets the run start time to the present and disables the Date/Time scroll arrows.
- The **Start At** button enables the Date/Time scroll arrows and sets the run to start at the time entered.
- The **Stop At** button enables the Date/Time scroll arrows and sets the run to end at the time entered. The system calculates the start time by subtracting the Run time from the Stop At time.

NOTE The **Stop At** feature is not available for a Hold run.

- The Date/Time scroll arrows change the date or time setting.
- The **Cancel** button discards your entry and dismisses the page.
- The **OK** button accepts your entry and dismisses the page.

Set Speed ω^2t Time Page

Figure 6.7 Set Speed ω^2t Time Page



When the ω^2t mode is active and you select either the **Set Speed** button or the **Set Time** button on the [Home Page](#) or the Footer Bar, the system displays the **Set Speed ω^2t Time** page. The ω^2t value is computed from the time and RPM (or RCF) values you enter. Use this page to set the values for the next run that produce the desired ω^2t value.

Use the **ω^2t Mode** button on [The Basic Tab](#) of the [System Options Page](#) to enable or disable ω^2t mode.

In addition to the Header Bar and the Footer Bar, the **Set Speed ω^2t Time** page contains the following elements:

- The **Set Speed** Display/Button shows the current Speed in RPM or RCF. Select this button to set a new speed value. The system then changes the ω^2t or time value, whichever you entered last, to reflect the new speed value.
- The **Set ω^2t Display**/Button shows the current ω^2t value. Select this button to set a new ω^2t value. The time then changes to reflect the new ω^2t value.
- The **Set Time** Display/Button shows the current time setting in hours and minutes. Select this button to set a new time value. The ω^2t value then changes to reflect the new time value.
- Use the **RPM/RCF** button to select the speed units. You must have a rotor selected to use RCF.
- The **Select Rotor** button displays the [Select Rotor Page \(Library\)](#).
- The keypad changes slightly depending on the value you are entering. For setting time, you can use the Hold key to set the time to a hold state with no countdown to an automatic end. For Display/Button setting ω^2t , use the decimal and e keys to enter values in exponential notation. You can use the **Clear** and **Back** keys to make corrections.
- The Delay Start button displays the [Delay Start Page](#).
- The **Cancel** button discards your changes and dismisses the page.
- The **OK** button accepts your changes and dismisses the page.

Set Temperature Page

Figure 6.8 Set Temperature Page

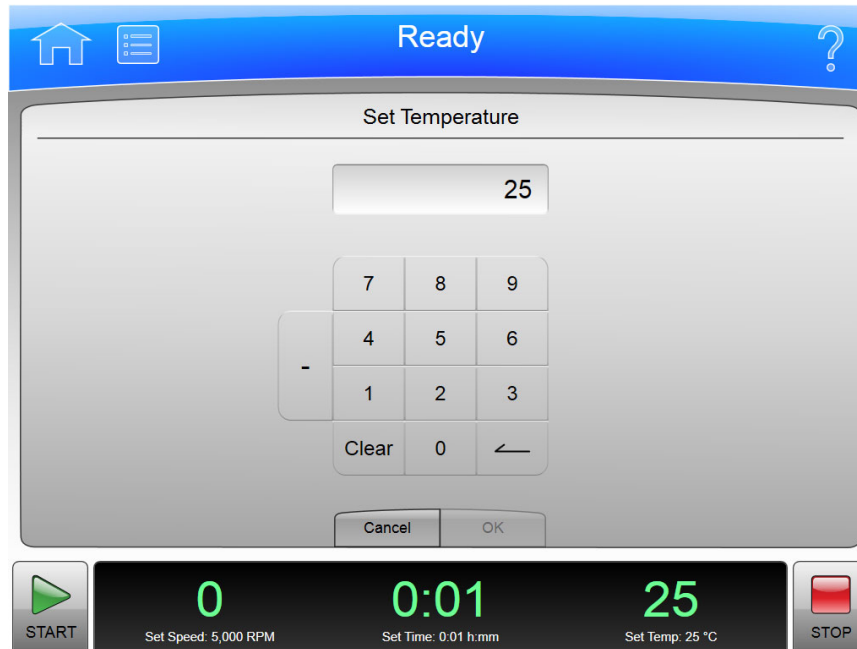

To set the temperature for the next run or change the temperature for the run in progress, select the **Set Temperature** button on the [Home Page](#) or the Footer Bar to display the **Set Temperature** page.

In addition to the Header Bar and the Footer Bar, the **Set Temperature** page contains the following elements:

- The Set Temperature Display shows the current **Set Temperature** setting in degrees Celsius.
- Use the keypad to change the temperature setting. You can use the **Clear** and **Back** keys to make corrections.
- The **Cancel** button discards your changes and dismisses the page.
- The **OK** button accepts your changes and dismisses the page.

Set Acceleration/Deceleration Profiles Page

Figure 6.9 Set Acceleration/Deceleration Profiles Page

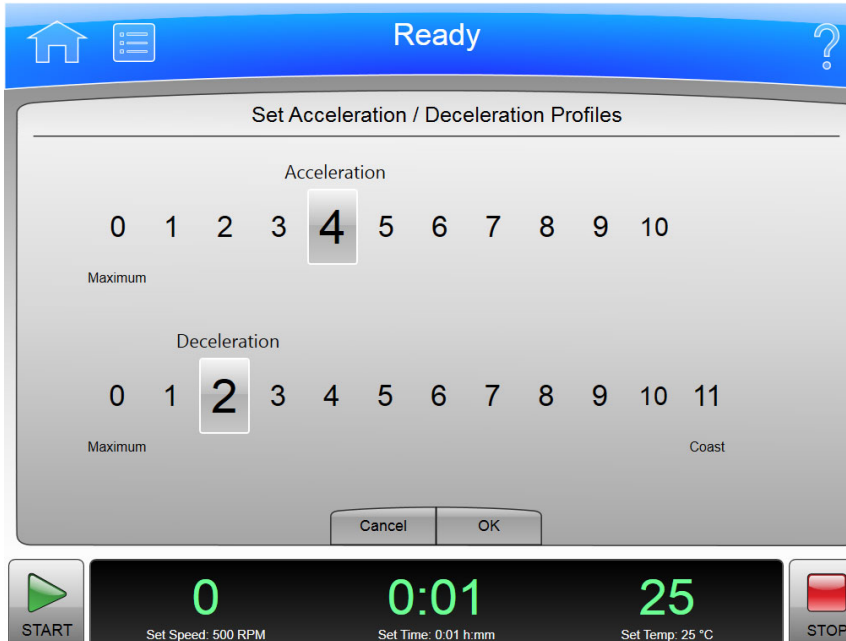

To choose profiles for acceleration and deceleration, select the **Accel/Decel** Display/Button in the Footer Bar of the [Home Page](#) to display the **Set Acceleration/Deceleration Profiles** page.

In addition to the Header Bar and the Footer Bar, the **Set Acceleration/Deceleration Profiles** page contains the following elements:

- Use Acceleration to select a numbered acceleration value.
- Use Deceleration to select a numbered deceleration value.
- The **Cancel** button discards your changes and dismisses the page.
- The **OK** button accepts your changes and dismisses the page.

The acceleration values are the degree of reduction from the maximum value. The acceleration value of zero is the maximum (no reduction). The acceleration value of 10 is the slowest (maximum reduction). The same applies to the deceleration values. The value 11 is an absolute reduction, eliminating all braking and allowing the rotor to coast to a stop.

Slower (numerically higher) acceleration and deceleration values minimize sample-to-gradient interface disturbance. Each acceleration profile has a designated time that it takes to reach a specified speed. After that, it uses maximum acceleration to reach run speed. For a deceleration profile, the instrument uses maximum deceleration until it reaches the specified speed, then takes the designated time to slow to a stop.

Example Acceleration and Deceleration Settings

The values associated with each acceleration and deceleration setting are given in the table below.

Table 6.1 Acceleration and Deceleration Profiles

Setting	Description
Maximum acceleration (not available with the JS-24.38 and JS-24.15 rotors)	Full torque is used from 0 RPM until set speed is reached.
Timed acceleration	Acceleration time from 0 to 500 RPM can be set from 1 to 10 minutes. Above 500 RPM, full torque is used until set speed is reached.
Maximum deceleration	Full brake from set speed to near 0 RPM. Reduce brake is used during the last few RPM until 0 is reached to minimize sample disturbance.
Timed deceleration	Full brake from set speed to 500 RPM. From 500 to 0 RPM, deceleration time can be set from 1 to 10 minutes.
Coast	No brake is used. Rotor coasts from set speed to 0 RPM. The time required for a rotor to come to a complete stop can vary from 1 to 9 hours depending upon the set speed while in operation and the rotor's mass.

Login Page

Figure 6.10 Login Page



If the user login requirement has been enabled for the instrument, you must log in to the system use it. Select the **Login** button on the [Home Page](#) to display the **Login** page.

To enable or disable the user login requirement, select **Require Login** on [The Users Tab](#) of the [System Options Page](#).

NOTE Only an Administrator can change this setting.

- To log in, select your User ID from the list on the left. Use the keypad to enter your PIN on the right, and select **Login**.
- Select **Cancel** to dismiss the page without logging in.

Select Program Page

Figure 6.11 Select Program Page



To select or manage your run programs, select the **Program** button on the [Home Page](#) to display the **Select Program** page. Operator-level users may only view and run programs.

In addition to the Header Bar and the Footer Bar, the **Select Program** page contains the following elements:

- Select a program from the list on the left to run, edit, view, delete, authorize users, and view program log. Select **•No Program•** and select **OK** to return to manual mode.
- Select **New** to create a new program. The system displays the [New Program Page](#).
- Select **Edit** to change the selected program. The system displays the [Edit Program Page](#).
- Select **View** to review the selected program without making changes to it. The system displays the [View Program Page](#).
- Select **Delete** to remove the selected program from the list. The system displays a confirmation message. Select **Yes** to remove the program.
- Select **Program Log** to display the [Program Log Page](#) for the selected program.

- Select **Authorize Users** to grant Operator-level users permission to run the selected program. The system displays the [Authorize Users Page](#).
- Select the **Cancel** button to discard your changes and dismiss the page.
- Select **Print** to print the selected program.
- Select **Export** to export the selected program. The system displays the [Export Page](#).
- Select **Import** to import a program. The system displays the [Import Page](#).
- The **OK** button accepts your program selection and dismisses the page. The system will run the selected program when you select **Start**.

New/Edit/View Program Page

Figure 6.12 New Program Page

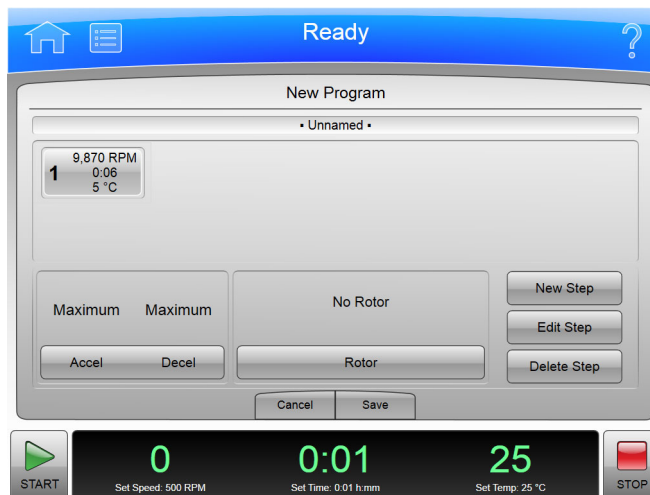

Figure 6.13 Edit Program Page

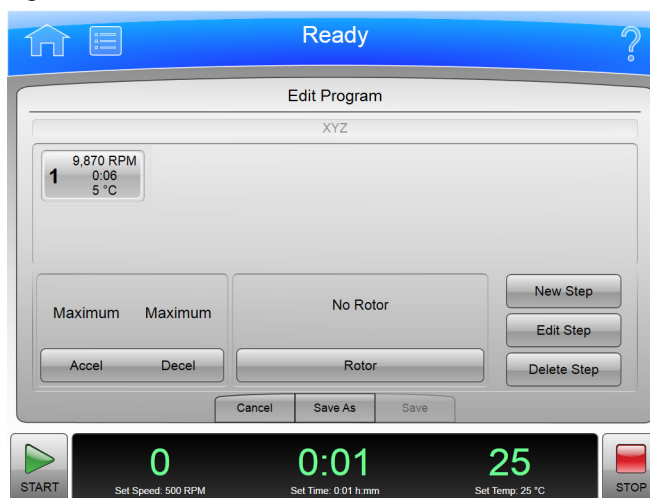
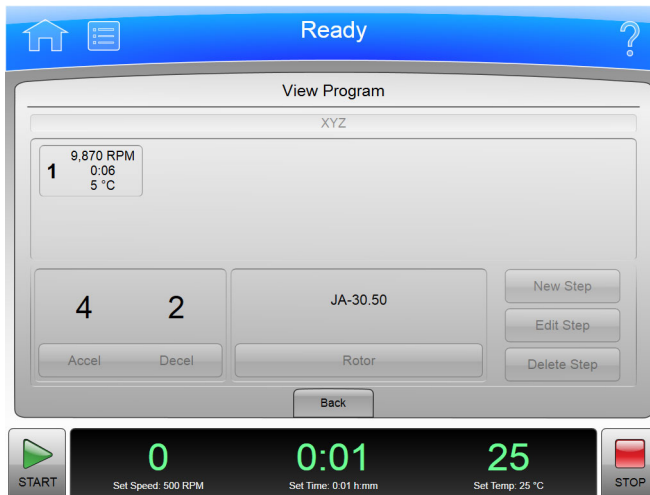

Figure 6.14 View Program Page



To create a run program, select the **New** button on the [Select Program Page](#) to display the **New Program** page. To edit or view a run program, select the program and select the **Edit** or **View** button on the [Select Program Page](#) to display the **Edit Program** or **View Program** page. The pages are identical except for which buttons are active. (The **View Program** page does not permit editing.)

In addition to the Header Bar and the Footer Bar, the **New/Edit/View Program** page contains the following elements:

NOTE No changes can be made on the **View Program** page.

- The program name appears at the top of the page. New programs appear as **•Unnamed•** until you save them, or select **•Unnamed•** to display the **New Program Name** page. Enter the name of the new program and select **OK** to enter the name.
- Program steps appear in the Step List.
- Acceleration and Deceleration Profiles appear in the Accel/Decel area. Select the **Accel/Decel** button to display the [Set Acceleration/Deceleration Profiles Page](#) to select new profiles.
- The selected rotor type appears in the Rotor area. To enter or change the rotor, select the **Rotor** button to display the [Select Rotor Page \(Catalog\)](#).
- Use the **New Step** button to display the [New Step Page](#) and add a new step to the program.
- To change a step, select the step and select the **Edit Step** button to display the [Edit Step Page](#).
- To delete a step, select the step and select the **Delete Step** button. The system displays a confirmation message. Select **Yes** to delete the step.
- The **Cancel** button discards your changes and dismisses the page.
- From the **Edit Program** page, you can use the **Save As** button to save the changed program as a new program. The system displays the **New Program Name** page. Enter the name of the new program and select **OK** to save the program. The original program remains unchanged.
- The **Save** button saves your entry and dismisses the page.

Select Rotor Page (Catalog)

Figure 6.15 Select Rotor Page (Catalog)



To select a type of rotor for a run program, select the **Rotor** button on the [New Program Page](#) or the [Edit Program Page](#) to display the **Select Rotor** page (Catalog). This page displays the complete list of rotors that can be used with the Avanti JXN series.

In addition to the Header Bar and the Footer Bar, the **Select Rotor** page contains the following elements:

- The Rotor Catalog List shows the rotors that can be used with the instrument. Select a rotor from this list to indicate the kind of rotor that must be used with the run program. When you run the program, the selection from the rotor library will be restricted to rotors of the same kind.
- The **Cancel** button cancels your selection and dismisses the page.
- The **OK** button saves the selection and dismisses the page.

For details about each rotor, use the [Rotor Catalog Page](#).

New/Edit Step Page

Figure 6.16 New Step Page

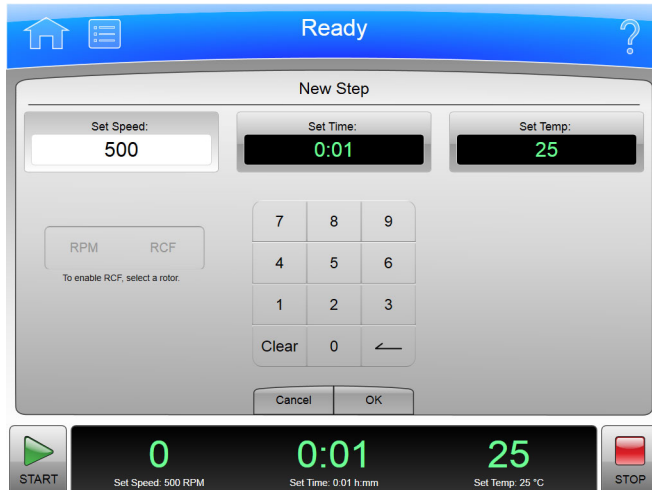
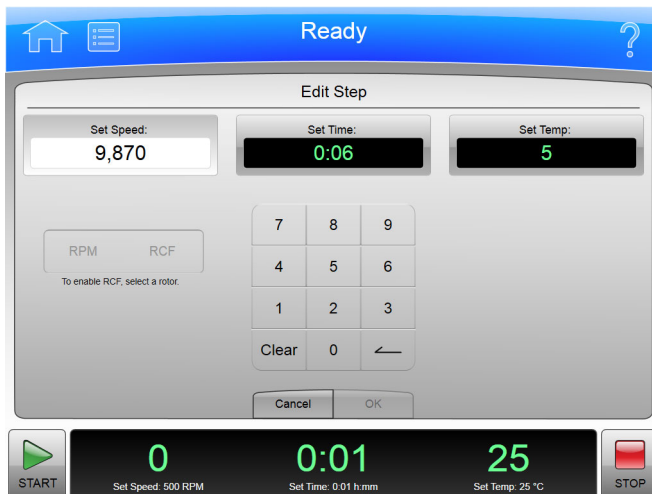

Figure 6.17 Edit Step Page



To create a step within a run program, select the **New Step** button on the [New Program Page](#) or the [Edit Program Page](#) to display the **New Step** page. To edit a step within a run program, select the step and select the **Edit Step** button on the [New Program Page](#) or the [Edit Program Page](#) to display the **Edit Step** page. The pages contain the same options.

In addition to the Header Bar and the Footer Bar, the **New/Edit Step** page contains the following elements:

- The **Set Speed** field shows the default or the current step Set Speed in RPM. The last digit is always zero. Select the field and use the keypad to change the entry as required. If you plan to set the speed in units of relative centrifugal field (RCF), select the **RPM/RCF** button.

NOTE The **RPM/RCF** button is only enabled when you have selected a rotor.

- The **Set Time** field shows the default or the current step Set Time in hours and minutes. Select the field and use the keypad to change the entry as required.
- The **Set Temp** field shows the default or current step Set Temperature setting in degrees Celsius. Select the field and use the keypad to change the entry as required.
- Use the keypad to change the settings as required. You can use the **Clear** and **Back** keys to make corrections.
- The **Cancel** button discards your changes and dismisses the page.
- The **OK** button saves your entry and dismisses the page.

Program Log Page

Figure 6.18 Program Log Page

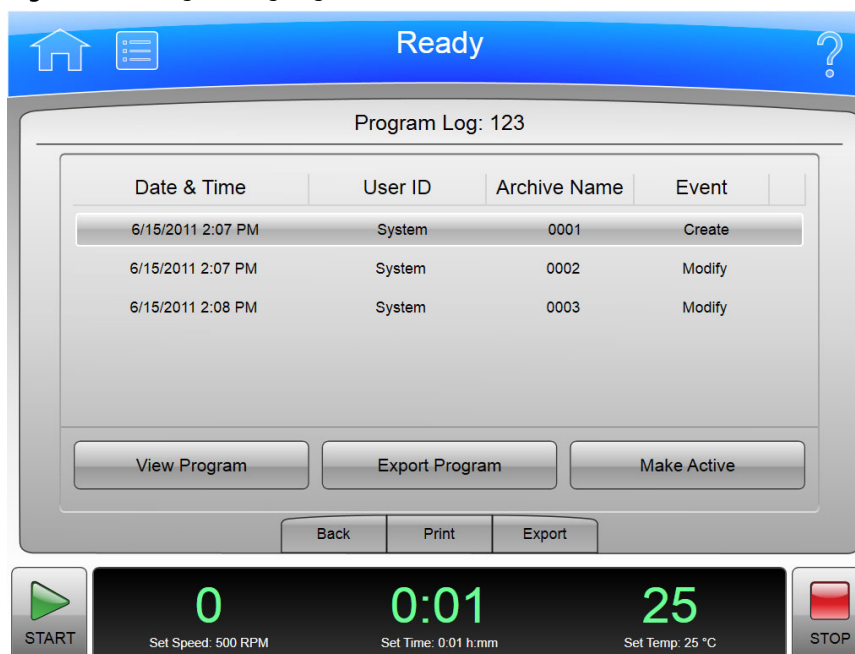

To display the history of changes to a run program, select the program and select the **Program Log** button on the [Select Program Page](#) to display the **Program Log** page for the selected program.

In addition to the Header Bar and the Footer Bar, the **Program Log** page contains the following elements:

- The name of the selected program appears at the top of the page.
- The log entry section lists all versions of the selected program.
- Select a version of the program and select **View Program** to display the [View Program Page](#) for the selected version.
- Select a version of the program and select **Export Program** to export the selected version. The system displays the [Export Page](#).
- Select an older version of the program and select **Make Active** to copy the selected version. The copy becomes the most current version of the program.

- Select the **Back** button to return to the [Select Program Page](#).
- Select **Print** to print the program log.
- Select **Export** to export the program log. The system displays the [Export Page](#).

Export Page

Figure 6.19 Export Page

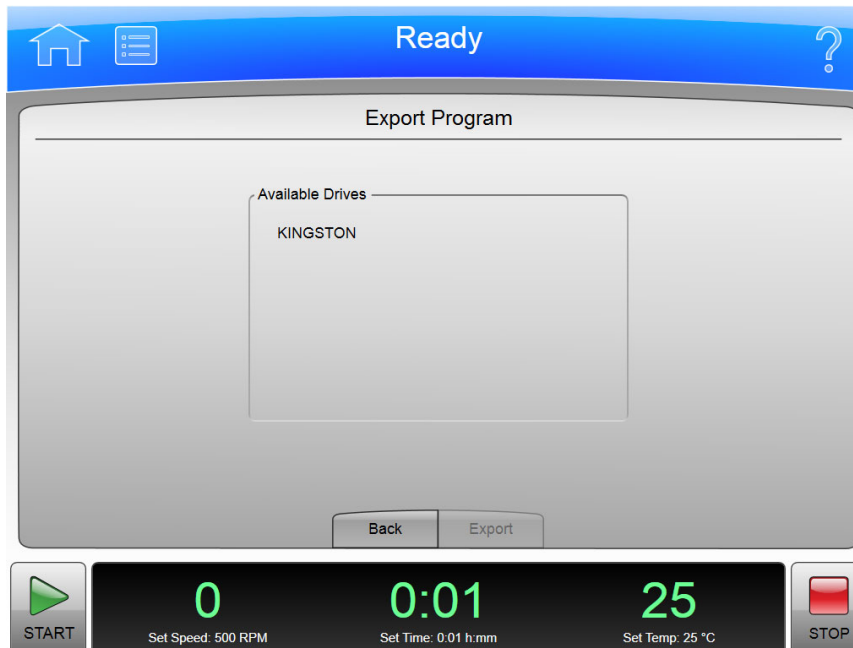

Different kinds of information can be exported from the Avanti JXN series to a USB device or network drive. All Export pages function in the same manner.

NOTE Do not remove a USB drive while a data transfer is in progress.

In addition to the Header Bar and the Footer Bar, the **Export** page contains the following elements:

- The Export Item at the top tells you what you are about to export (About information, diagnostic messages, programs, the program log, run history, or the system options log).
- The Available Drives list shows all the available network and USB drives. Attach a USB device if necessary. Select the destination drive.
- The **Back** button returns to the previous page without exporting information.
- The **Export** button copies the information to the selected drive.

Authorize Users Page

Figure 6.20 Authorize Users Page

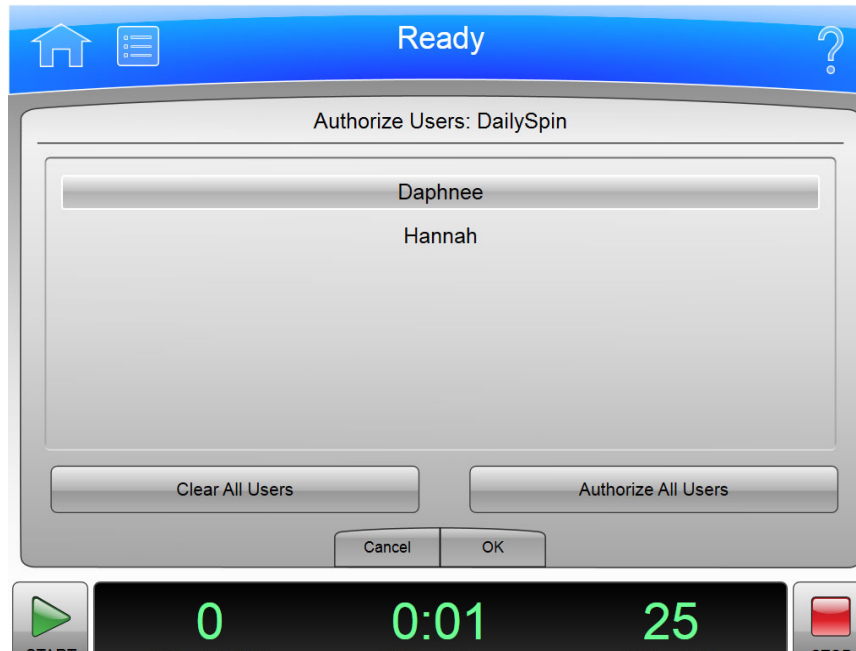

To manage the list of users with permission to run a program, select the program and select the **Authorize Users** button on the [Select Program Page](#) to display the **Authorize Users** page.

In addition to the Header Bar and the Footer Bar, the **Authorize Users** page contains the following elements:

- The program name appears at the top of the page.
- The list box displays the Operator-level users in the system. Users with permission to run the program are highlighted.
- To grant permission to additional users, select the users.
- To remove permission for all users, select **Clear All Users**.
- To grant permission to all current users, select **Authorize All Users**.
- Select the **Cancel** button to discard your changes and return to the [Select Program Page](#).
- Select the **OK** button to accept your changes and return to the [Select Program Page](#).

Import Page

Figure 6.21 Import Page

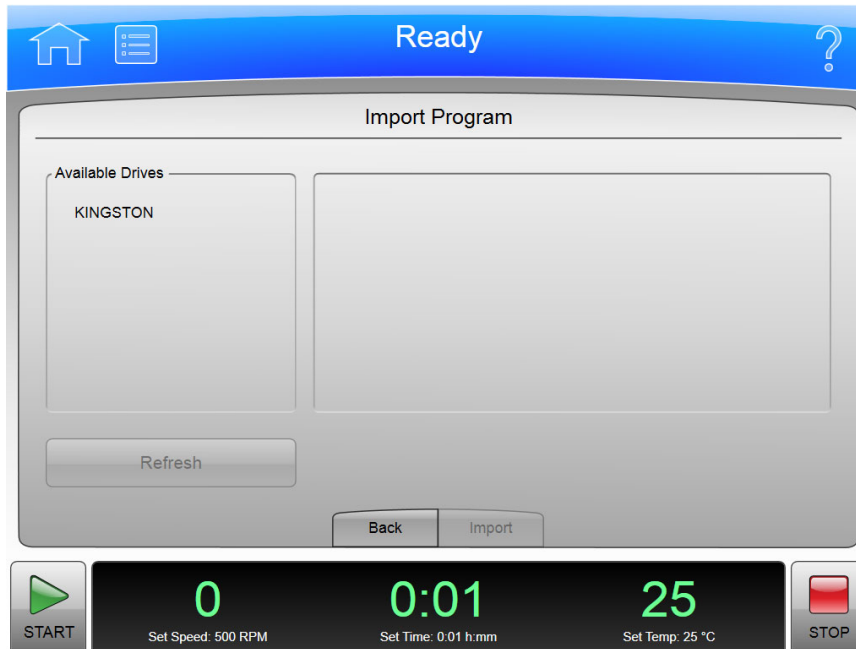

Many kinds of information can be imported to the Avanti JXN series from a USB device or network drive. All Import pages function in the same manner.

NOTE Do not remove a USB drive while a data transfer is in progress.

In addition to the Header Bar and the Footer Bar, the **Import** page contains the following elements:

- The Import Item at the top tells you what you are about to import (images, programs, custom sound files).
- The Available Drives list shows all the available network and USB drives. Attach a USB device if necessary. Select the appropriate drive.
- Select **Refresh** to update the file list of the selected drive.
- When you select a drive, the system displays the available files on the right. Select the file to import.
- The **Back** button returns to the previous page without importing information.
- The **Import** button imports the selected file.

Real-Time Run Data/Historical Run Data Page

Figure 6.22 Real-Time Run Data Page

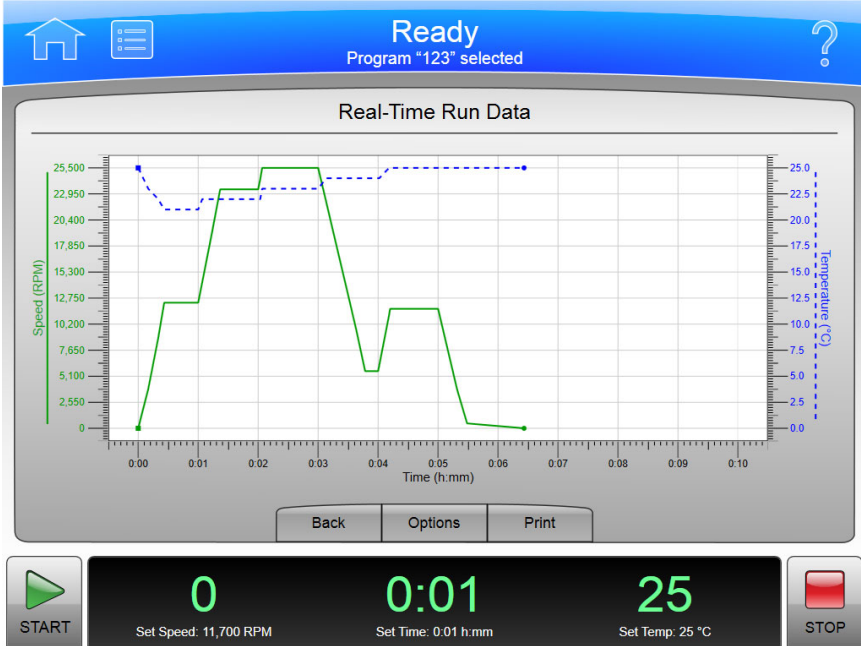
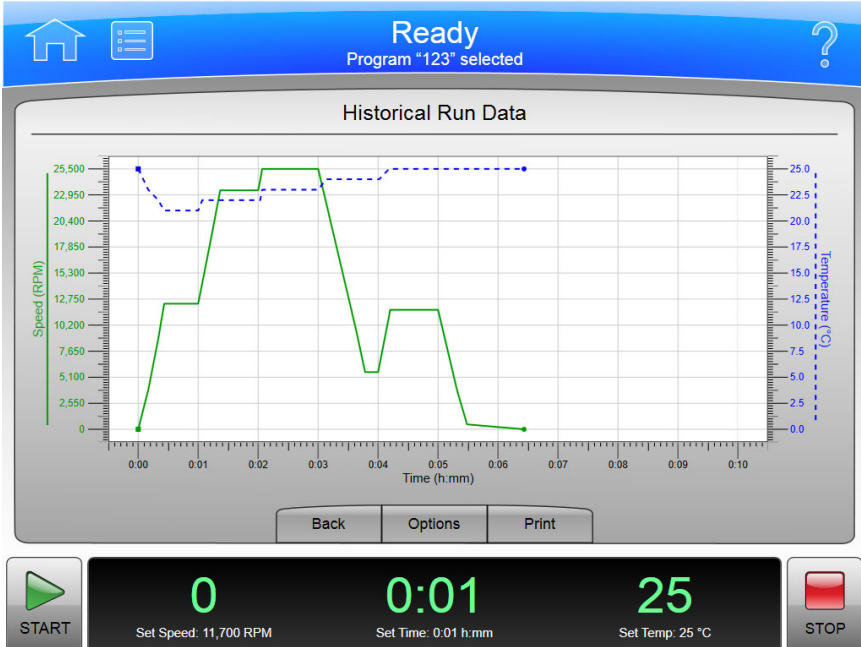

Figure 6.23 Historical Run Data Page



Select the **Run Graph** button on the side menu of the **Home Page** to display the **Real-Time Run Data** page. This page graphs the current run as it is in progress, or shows the most recent run.

Figure 6.24 Run Graph Button



Select a run log from the [Run History Page](#) and select the **Graph** button to display the **Historical Run Data** page for the selected run.

In addition to the Header Bar and the Footer Bar, the Real-Time Run Data page contains the following elements:

- The **Back** button returns to the previous page.
- The **Options** button displays the Run Graph Options page.
- The **Print** button prints the graph.

Run Graph Options Page

Figure 6.25 Run Graph Options Page

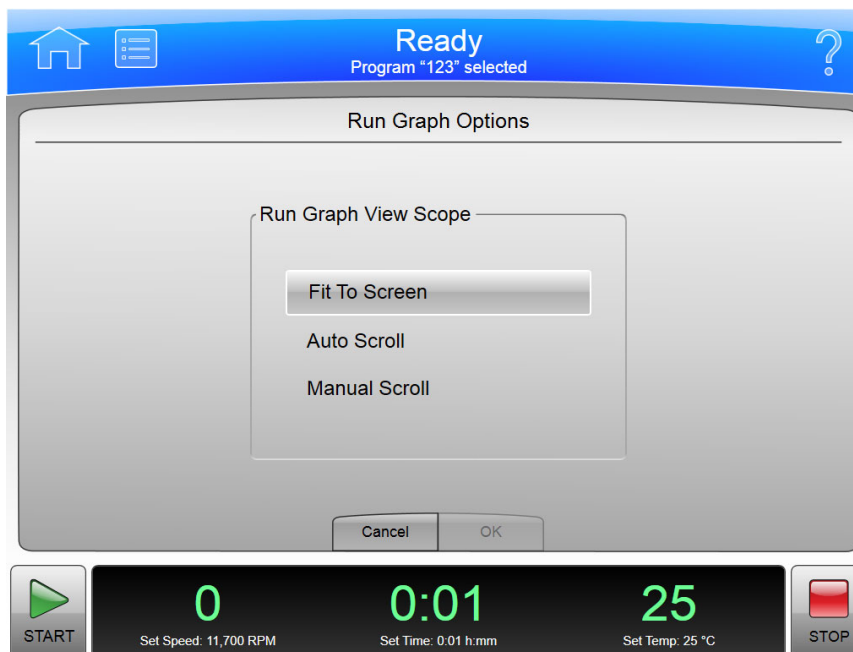

Select the **Options** button on the [Real-Time Run Data/Historical Run Data Page](#) to display the **Run Graph Options** page. Use this page to configure scroll options for your run graph.

In addition to the Header Bar and the Footer Bar, the **Run Graph Options** page contains the following elements:

- The **Fit To Screen** button displays the entire run on the run graph page.
- The **Auto Scroll** button displays the last 10 minutes of the historical run or the run in progress, and cannot be scrolled back.

- The **Manual Scroll** button displays the last 10 minutes of the run, with a scroll bar beneath the run graph to scroll through the entire run.
- Select the **Cancel** button to discard your changes and return to the previous page.
- Select the **OK** button to accept your changes and return to the previous page.

Run History Page

Figure 6.26 Run History Page

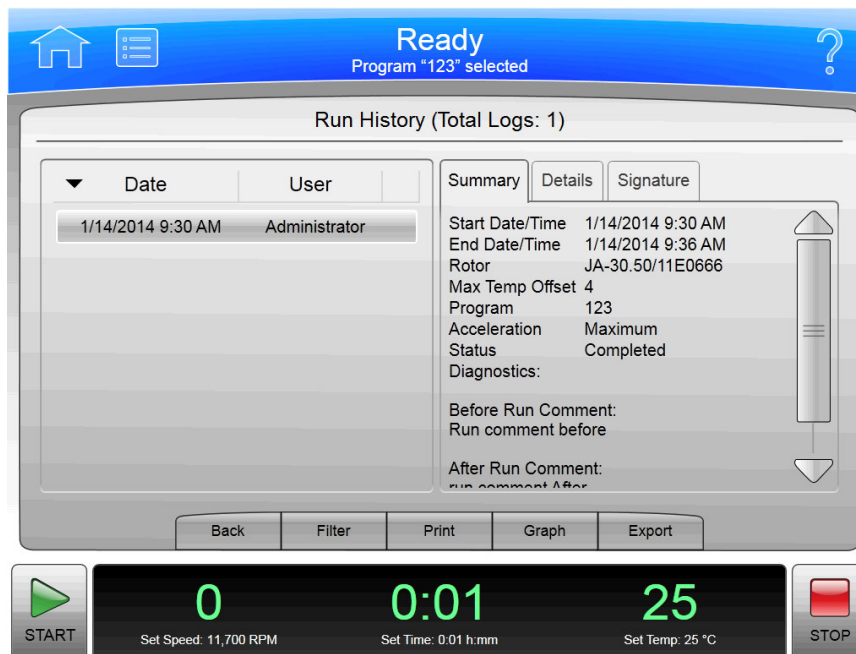
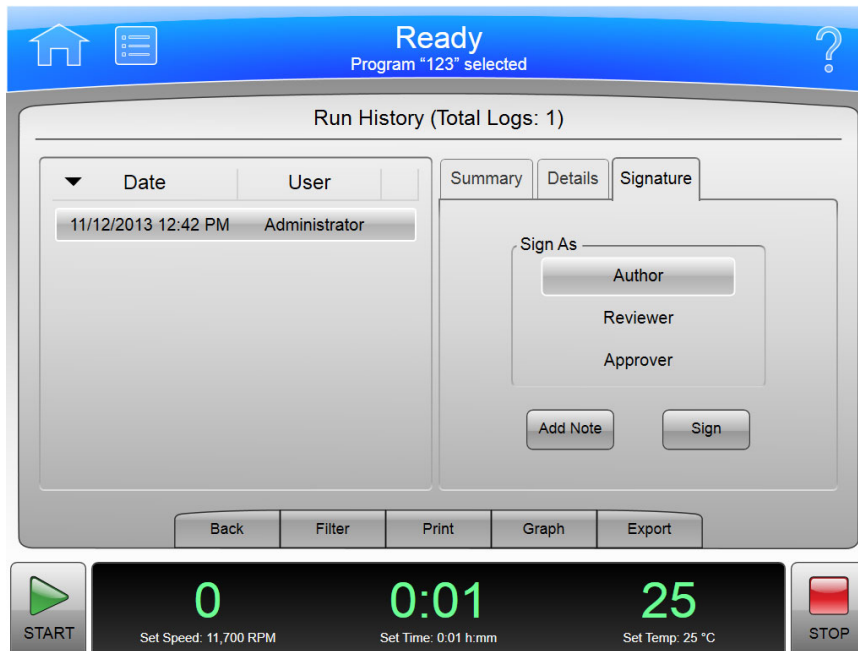

Figure 6.27 Run History Page (E-Signature Enabled)



Select the **Run History** button on the side menu of the [Home Page](#) to display the **Run History** page.

Figure 6.28 Run History Button



In addition to the Header Bar and the Footer Bar, the **Run History** page contains the following elements:

- The run logs for all instrument runs are listed on the left. Select a run log to review.
- The **Summary** tab shows summary details for the selected run.
- The **Details** tab shows detailed information for each step of the selected run.
- If your system has E-Signature enabled (see [The Reports Tab](#)), use the **Signature** tab to sign off on the run as the Author, Reviewer, or Approver. You must select a role to enable the **Add Note** and **Sign** buttons. Active options are determined by your user level. The Signature tab contains the following elements:
 - Select **Author** to sign the run log as the author.
 - Select **Reviewer** to sign the run log as the reviewer.
 - Select **Approver** to sign the run log as the approver.
 - You can optionally select **Add Note** to display the **Add Note** page. Enter your note and select **Sign** to display the **Sign** page. Enter your PIN and select **OK** to sign the run and display the **Run History** page.
 - Select **Sign** to display the **Sign** page. Enter your PIN and select **OK** to sign the run and display the **Run History** page.
- The **Back** button returns to the previous page.

- The **Filter** button displays the [Run History Filter Page](#).
- The **Print** button prints all the listed run logs. (Use **Filter** to narrow the list.)
- The **Graph** button displays the [Historical Run Data Page](#) for the selected run log.
- The **Export** button exports all the listed run logs. (Use **Filter** to narrow the list.) The system displays the **Export** page.

Run History Filter Page

Figure 6.29 Run History Filter Page

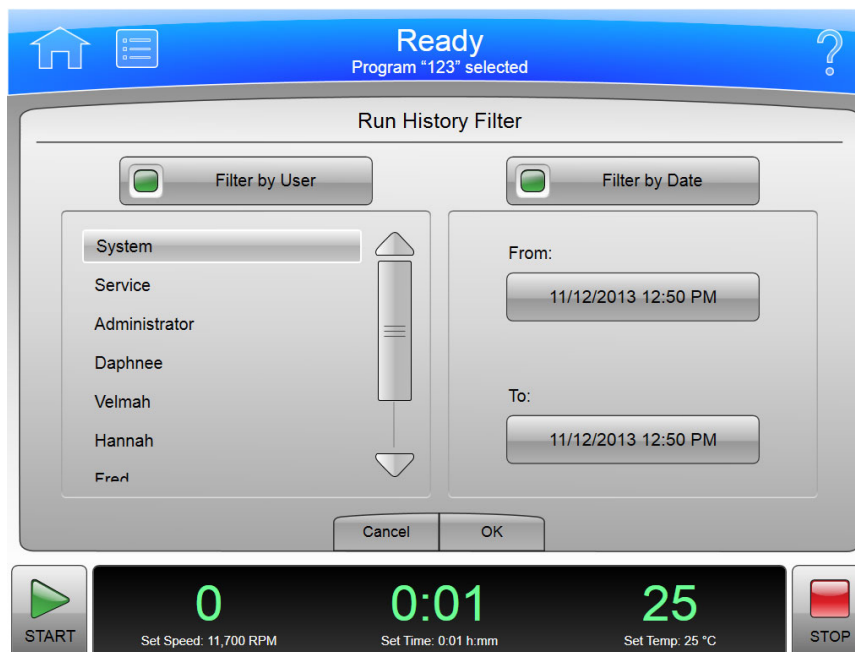

Select the **Filter** button on the [Run History Page](#) to display the **Run History Filter** page. Use this page to narrow the parameters for the run logs that will be displayed, printed or exported on the [Run History Page](#).

In addition to the Header Bar and the Footer Bar, the **Run History Filter** page contains the following elements:

- The **Filter by User** button enables the user list. Select a user from the list to limit the run log display to the runs performed by the selected user.
- The **Filter by Date** button enables the From and To fields. Select the fields to display the Set Date pages and enter a date range to which to limit the run log display.
- Select the **Cancel** button to discard your entries and return to the [Run History Page](#).
- Select the **OK** button to accept your entries and return to the [Run History Page](#).

Before Run/After Run Comment Page

Figure 6.30 Before Run Comment Page

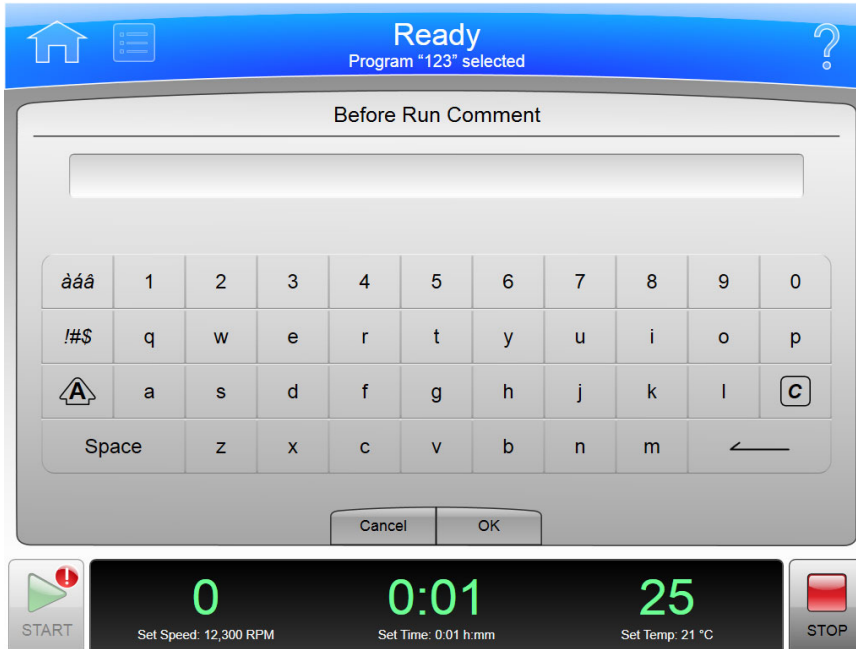

If your system has Run Comments enabled (see [The Reports Tab](#)), it displays the **Before Run Comment** page when you start a run, and the **After Run Comment** page when a run ends.

In addition to the Header Bar and the Footer Bar, the Run Comment pages contains the following elements:

- Use the keypad to enter your comment.
- The **Cancel** button discards your comment and dismisses the page.
- The **OK** button accepts your comment and dismisses the page.

Menu Page

Figure 6.31 Menu Page

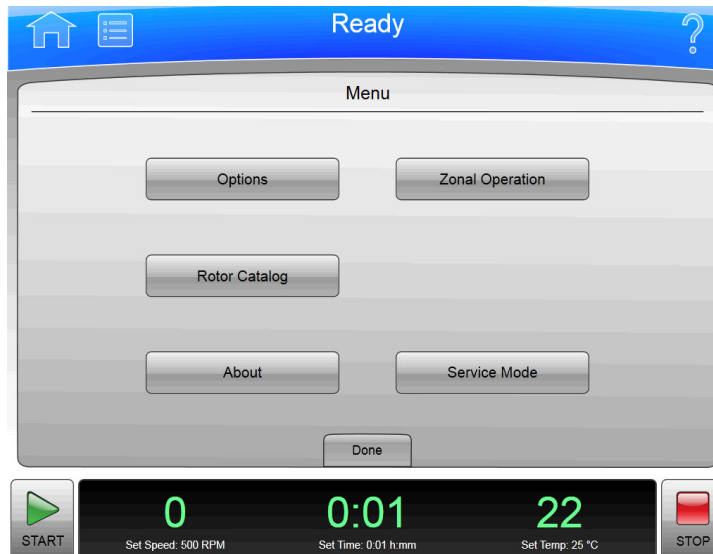

Select the **Menu** button in the Header Bar to display the **Menu** page. Use this page to configure or use the Avanti JXN series options.

- The **Options** button displays the [System Options Page](#).
- The **Rotor Catalog** button displays the [Rotor Catalog Page](#).
- The **About** button displays the [About Page](#).
- The **Zonal Operation** button displays the [Zonal Authorization Page](#).
- The **Service Mode** button is used by service personnel only. If you select this button and display the **Service Login** page, select the **Cancel** button to dismiss the page.
- The **Done** button dismisses the page.

System Options Page

Figure 6.32 System Options Page, Basic Tab



Select the **Options** button in the **Menu** page to display the **System Options** page. Use this page to configure the system option settings.

The **System Options** page is organized into five tabs. If you have user login enabled, many of the options are restricted to Admin-level users. (See the [Manage Users Page](#) for more information.) If a button is greyed out, you do not have access to the option.

In addition to the Header Bar and the Footer Bar, the **System Options** page contains the following elements organized on five tabs:

The Basic Tab

- The **Select Language** button displays the [Select Language Page](#).
- The **User Options** button displays the [User Options Page](#).
- The **ω²t Mode** button enables and disables the ω²t mode. The mode is on when the green square is visible. See the [Set Speed ω²t Time Page](#) for details.
- The **Max Temperature Offset** button displays the [Max Temperature Offset Page](#).
- The **Max Temperature Shutdown** button enables and disables instrument shutdown if the maximum temperature offset is exceeded. When the green square is visible, the instrument will stop the run in the event the maximum temperature offset is exceeded. When the green square is not visible, the instrument will notify the user that the maximum temperature offset was exceeded, but not shut down the run.

The System Tab

Figure 6.33 System Options Page, System Tab

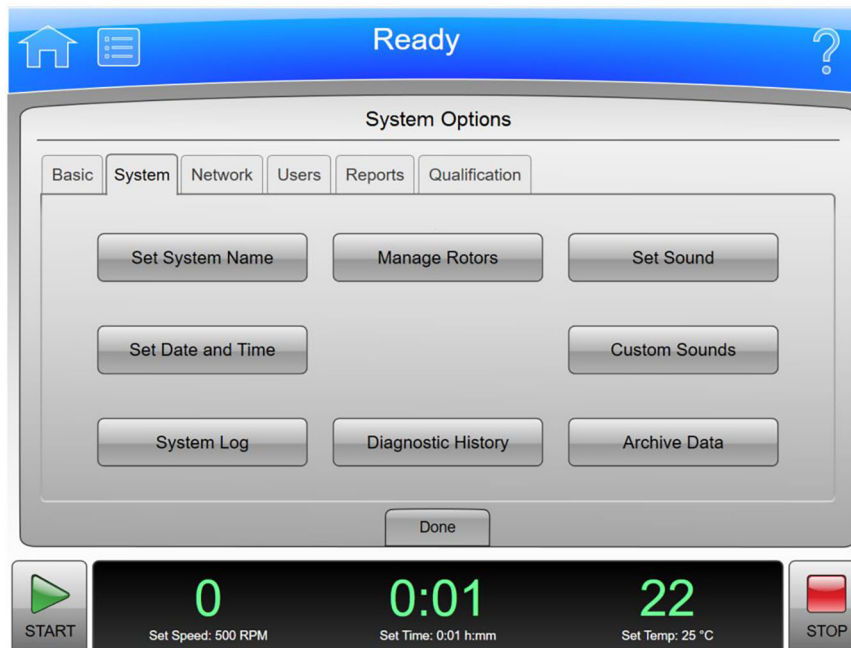

- The **Set System Name** button displays the **Set System Name** page. Enter the system name and select **OK** to return to the **System Options** page.
- The **Set Date and Time** button displays the [Set Date and Time Page](#).
- The **System Log** button displays the [System Log Page](#).
- The **Manage Rotors** button displays the [Manage Rotors Page](#).
- The **Diagnostic History** button displays the [Diagnostic History Page](#).
- The **Set Sound** button displays the [Set Sound Page](#).
- The **Custom Sounds** button displays the [Custom Sounds Page](#).
- The **Archive Data** button displays the [Archive Data Page](#).

The Network Tab

Figure 6.34 System Options Page, Network Tab

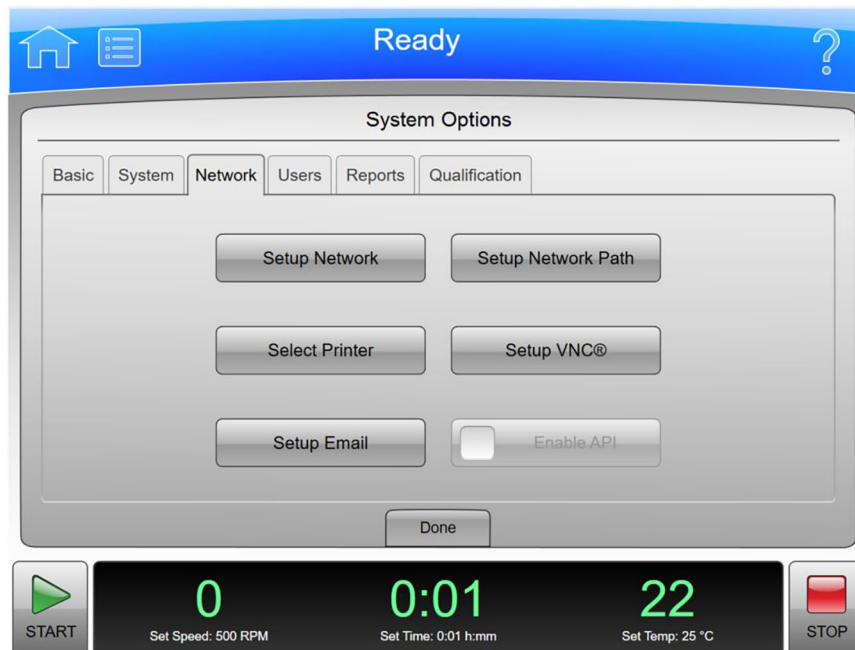

- The **Setup Network** button displays the [Setup Network Page](#).
- The **Select Printer** button displays the [Select Printer Page](#).
- The **Setup Email** button displays the [Setup Email Page](#).
- The **Setup VNC** button displays the [Setup VNC Page](#).
- The **Enable API** button enables and disables the Applications Programming Interface for remote devices. Contact your Beckman Coulter Representative for more information.

The Users Tab

Figure 6.35 System Options Page, Users Tab

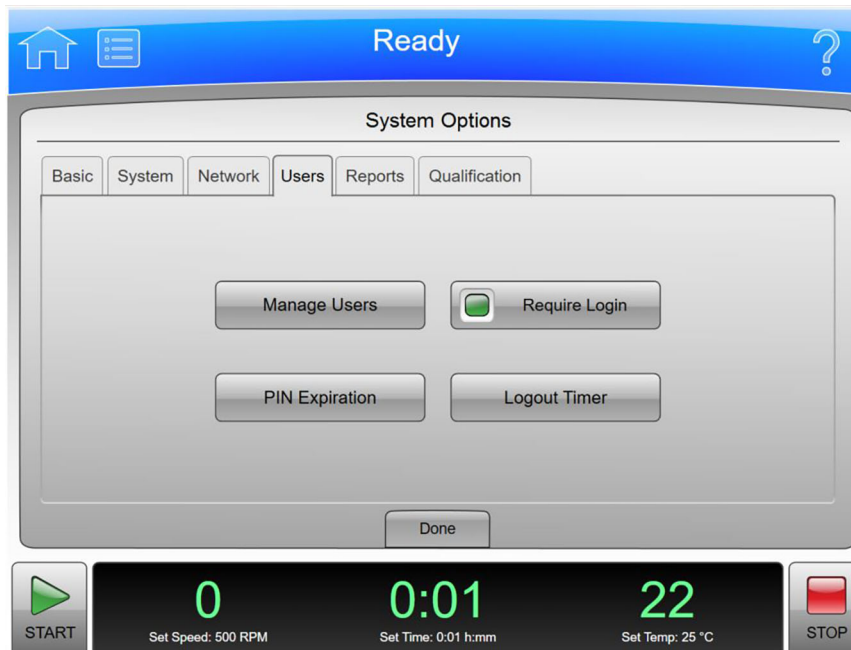

- The **Manage Users** button displays the [Manage Users Page](#).
- The **PIN Expiration** button displays the **PIN Expiration Page**. Enter the number of days that you want PINs to remain valid. To disable PIN Expiration, enter 0 and select **OK** to return to the [System Options Page](#).

NOTE The PIN Expiration Page allows you to configure the amount of time before the PIN expires.

- The **Require Login** button enables and disables the user login requirement.
- The **Logout Timer** button displays the Logout Timer page. Change the field to the number of minutes of inactivity before the system logs out a user. To disable the Logout Timer, enter 0 and select **OK** to return to the [System Options Page](#).

The Reports Tab

Figure 6.36 System Options Page, Reports Tab

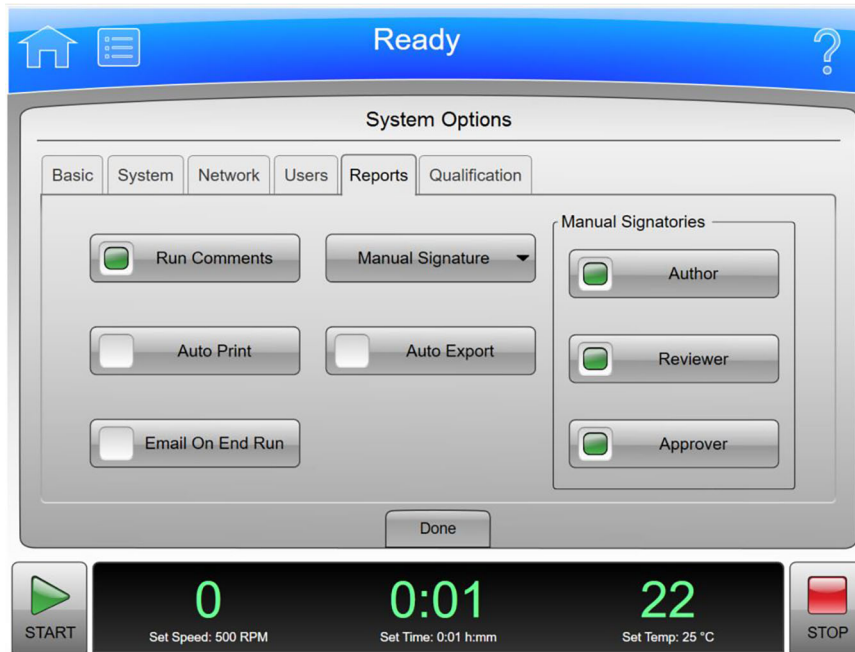

- The **Run Comments** button enables and disables the Before Run and After Run comment requirement.
- The **Manual Signature** drop down box allows choice of signature options. See [Signature Options](#) for more information.
- The **Auto Print** button enables and disables automatic printing of run logs at the completion of each run. See [Auto Print and Auto Export Run History Data](#) for more information.
- The **Auto Export** button enables and disables automatic export of run logs at the completion of each run. See [Auto Print and Auto Export Run History Data](#) for more information.
- The **Email on End Run** button enables and disables sending an automatic email at the conclusion of each run. If your system is configured for email, it will send an end of run notification to the user that initiated the run.
- The **Manual Signatories** buttons enable which signature lines will be included in a report when it is exported.

The Qualification Tab

Figure 6.37 Systems Options Page, Qualification Tab

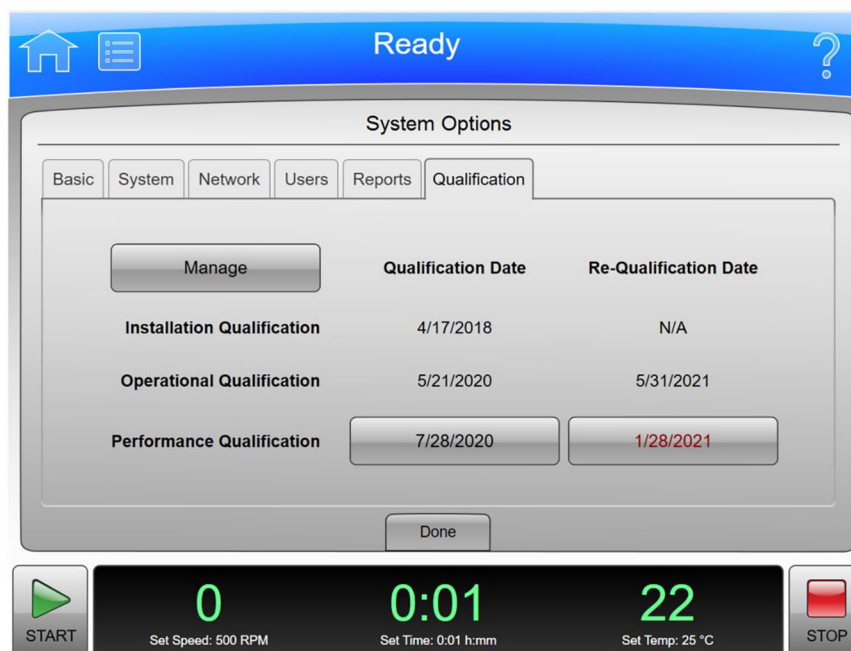

Avanti JXN can provide instrument qualification status and the ability to enable a qualification alert.

NOTE You must have Administrator access to enter PQ dates and enable the qualification alert.

- To enable alerts, select the **Manage** button to display the Qualification Management page. Select the **Enable Alerts** button. The small box in the **Enable Alerts** button will turn green to indicate that it is enabled. The **Qualification Alert** icon will be displayed at the top of the screen within 30 days of the re-qualification date and will continue to be displayed after the date. Operational Qualification Expiration Time Period can be selected as 6 months or 12 months.
- Installation Qualification (IQ) - Qualification at installation performed by a BCI Service Technician.
- Operational Qualification (OQ) - Certified qualification performed at either 6 or 12 month interval by a BCI Service Technician.
- Performance Qualification (PQ) - Workflow verification performed by a user lab at a user-selected interval.

Select Language Page

Figure 6.38 Select Language Page

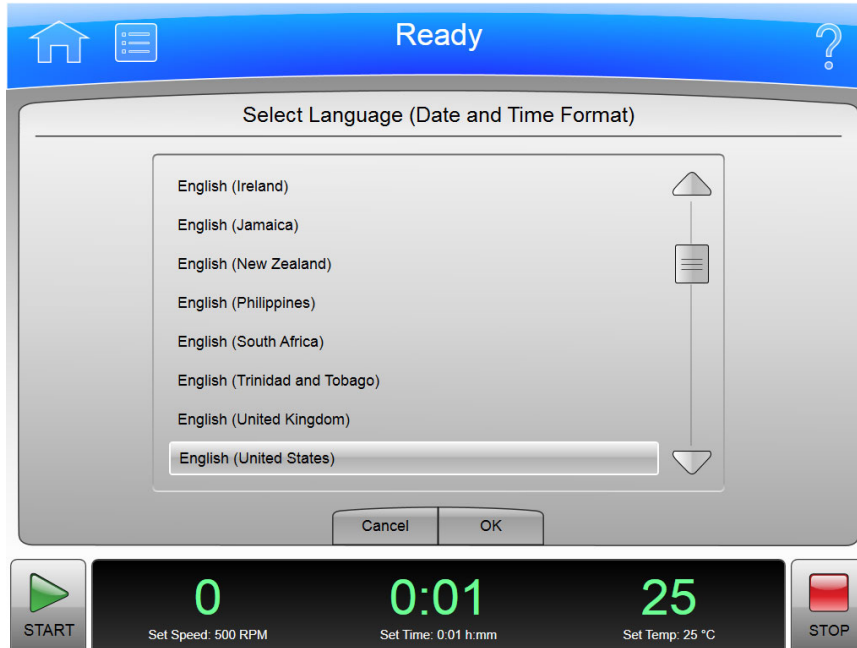

Select the **Select Language** button on the Basic tab of the [System Options Page](#) to display the **Select Language** page. Use this page to choose the language and date, time and number format the instrument uses in operations.

In addition to the Header Bar and the Footer Bar, the **Select Language** page contains the following elements:

- The List of Languages shows all the languages and countries available for the instrument. Scroll through this list and select a **Language** and **Country**.
- The **Cancel** button discards your selection and returns to the [System Options Page](#).
- The **OK** button saves your selection and returns to the [System Options Page](#) with the newly-selected language active on all pages.

NOTE Be careful not to select a language that you do not understand. If you don't understand the display language, select the Menu button, then select the upper left button (Options), select the first tab (Basic), and then select the top button (Select Language).

User Options Page

Figure 6.39 User Options Page

The screenshot shows the 'User Options: Administrator' page. At the top, a blue header bar contains a home icon, a menu icon, the word 'Ready', and a question mark icon. Below this, the page title 'User Options: Administrator' is centered. The main area features three input fields: 'PIN' (with masked characters), 'Email', and 'Phone Number'. Below these are two buttons: 'Set Avatar' and 'Set Background'. At the bottom center is a 'Done' button. The footer bar is black and contains a 'START' button with a green play icon, three digital displays showing '0', '0:01', and '25' with their respective units (Set Speed: 500 RPM, Set Time: 0:01 h:mm, Set Temp: 25 °C), and a 'STOP' button with a red stop icon.

Select the **User Options** button on the Basic tab of the [System Options Page](#) to display the **User Options** page. Use this page to configure personal options and information for your User ID.

NOTE You can display this page only if Require Login is enabled (see [The Users Tab](#)).

In addition to the Header Bar and the Footer Bar, the **User Options** page contains the following elements:

- Select **PIN** to display the [Reset User PIN Page](#).
- Select **Email** to display the Enter Email page. If your system is configured for email, it will send all diagnostic messages to the address you enter. If enabled, it will also send an end of run notification to the user that initiated the run. Select **Save** to return to the [User Options Page](#).
- Select **Phone Number** to display the Enter Phone Number page. Enter your phone number and select **Save** to return to the User Options page.
- Select the **Set Avatar** button to select or import an image to appear in the Footer Bar of the Home page when you are logged on. The system displays the [Select Image Page](#).
- Select the **Set Background** button to select or import an image to appear as the background in the Footer Bar of the Home page when you are logged on. The system displays the [Select Image Page](#).
- The **Done** button dismisses the page.

Max Temperature Offset Page

Figure 6.40 Max Temperature Offset Page

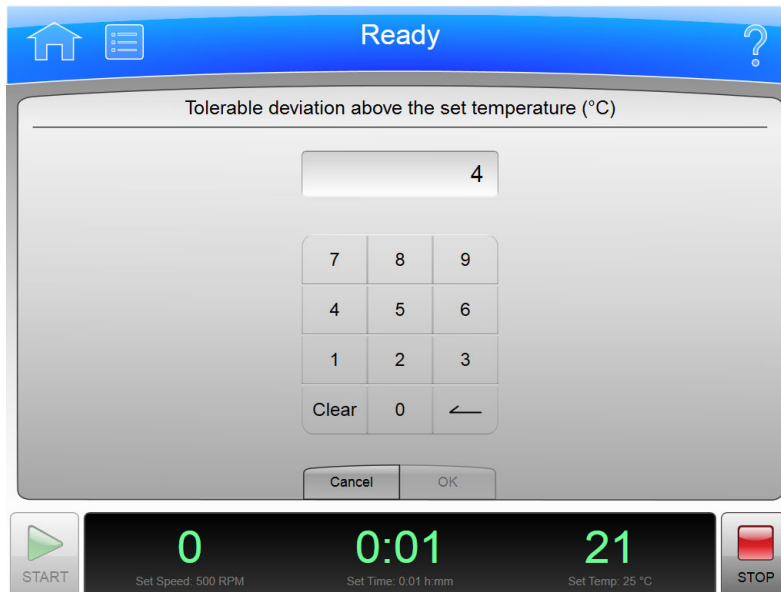

Select the **Max Temperature Offset** button on the Basic tab of the [System Options Page](#) to display the **Max Temperature Offset** page. Use this page to set the tolerable deviation above the set temperature during a run. Once the tolerable deviation above the set temperature has been selected, the user can specify whether the run should shut down or continue if the overtemp setting is reached by using the **Max Temperature Shutdown** button on the Basic tab of the [System Options Page](#).

In addition to the Header Bar and the Footer Bar, the **Max Temperature Offset** page contains the following elements:

- The **Tolerable Deviation Above the Set Temperature** page shows the current setting in degrees Celsius. The system default is 4°C.
- Use the keypad to change the setting. You can use the **Clear** and **Back** keys to make corrections.
- The **Cancel** button discards your changes and dismisses the page.
- The **OK** button accepts your changes and dismisses the page.

Reset User PIN Page

Figure 6.41 Reset User PIN Page

The screenshot shows the 'Reset User PIN: Administrator' interface. At the top, a blue header bar contains a home icon, a menu icon, the word 'Ready', and a question mark icon. Below this, the main content area is titled 'Reset User PIN: Administrator'. It contains three input fields: 'Enter PIN' (with three green dots), 'Enter new PIN' (with three green dots), and 'Confirm new PIN' (with three black dots). Below the input fields is a numeric keypad with buttons for digits 1-9, 0, and a back arrow, along with a 'Clear' button. At the bottom of the keypad area are 'Cancel' and 'Save' buttons. The footer bar at the bottom of the screen contains a 'START' button (green play icon), three large green numbers: '0' (Set Speed: 500 RPM), '0:01' (Set Time: 0:01 h:mm), and '25' (Set Temp: 25 °C), and a 'STOP' button (red stop icon).

Select the **PIN** field on the [User Options Page](#) to display the **Reset User PIN** page. Use this page to change the PIN for your User ID.

In addition to the Header Bar and the Footer Bar, the **Reset User PIN** page contains the following elements:

- Enter your current PIN in the **Enter PIN** field.
- Enter your new PIN in the **Enter new PIN** field.
- Enter the same PIN in the **Confirm new PIN** field.
- Select the **Cancel** button to discard your changes and return to the [User Options Page](#).
- Select the **Save** button to save your changes and return to the [User Options Page](#).

Select Image Page

Figure 6.42 Select Image Page (Avatar)

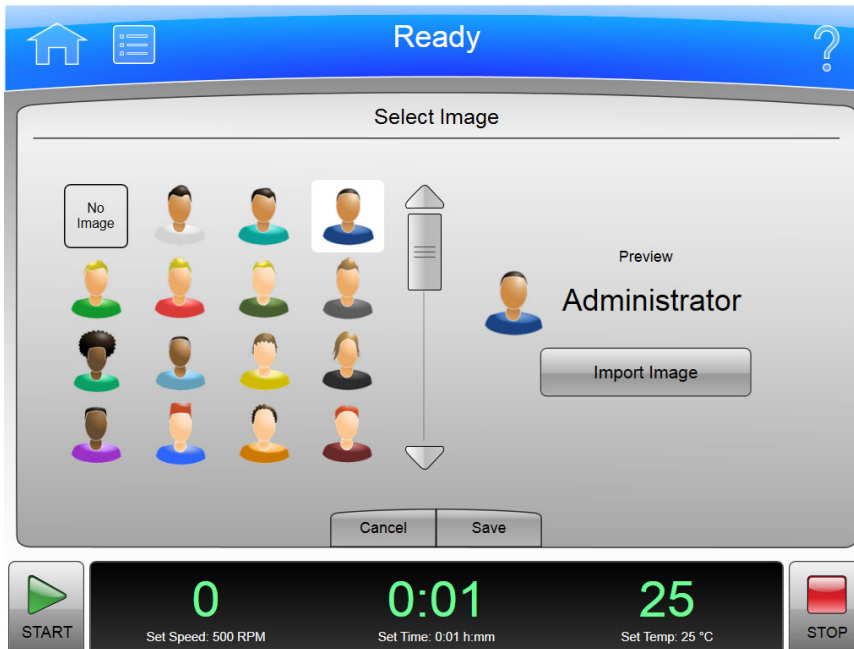
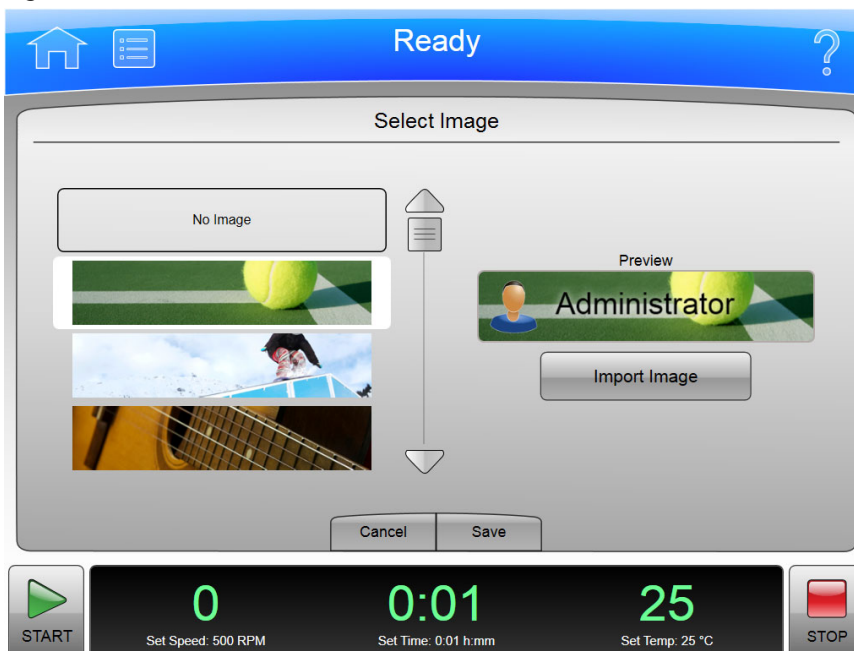

Figure 6.43 Select Image Page (Background)



Select the **Set Avatar** button or the **Set Background** button on the [User Options Page](#) to display the **Select Image** page. Use this page to select or import an avatar or background for your User ID on the Avanti JXN series.

In addition to the Header Bar and the Footer Bar, the **Select Image** page contains the following elements:

- The Image list shows all the available avatar or background images.
- Select **Import Image** to import an image from a network drive or USB device. The system displays the [Import Page](#).
- Select the **Cancel** button to discard your changes and return to the [User Options Page](#).
- Select the **Save** button to save your changes and return to the [User Options Page](#).

NOTE The system supports .jpg and .png file formats. Images must be less than 50 KB for Background Image, and 20 KB for Avatar.

Set Date and Time Page

Figure 6.44 Set Date and Time Page



Select the **Set Date and Time** button on System tab of the [System Options Page](#) to display the **Set Date and Time** page. Use this page to set the instrument's internal time and date.

In addition to the Header Bar and the Footer Bar, the **Set Date and Time** page contains the following elements:

- The Month-Day-Year controls set the date. Select the arrow buttons to increase or decrease the numbers.
- The Hour-Minute-AM/PM controls set the time. The AM/PM value has only one arrow button enabled at a time.
- The **Select Time Format** buttons set the time format. The 12 Hour format button displays a 12 hour clock with AM and PM. The 24 Hour format button displays a 24 hour clock without AM

and PM notation. With some language/country selections, the 12 hour option may be unavailable and the **Select Time Format** buttons will not be visible.

- The **Cancel** button discards your changes and returns to the [System Options Page](#).
- The **OK** button accepts your changes and returns to the [System Options Page](#).

System Log Page

Figure 6.45 System Log Page

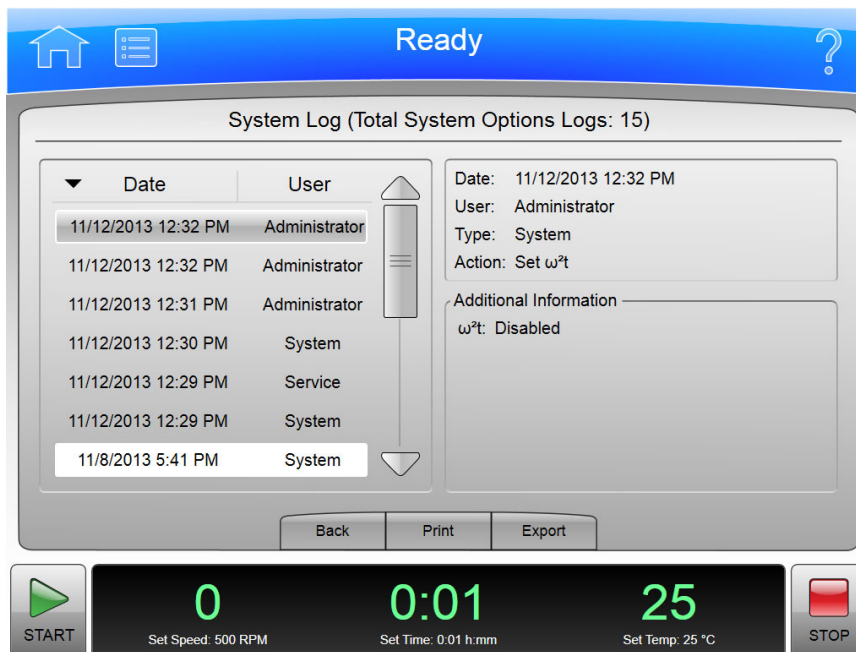

To display the history of changes to the system, select the **System Log** button on the System tab of the [System Options Page](#) to display the **System Log** page.

In addition to the Header Bar and the Footer Bar, the **System Log** page contains the following elements:

- The log entry list on the left lists the date and responsible user for each system option modified. Select an entry to display the details on the right.
- The Details section on the right shows detailed information for the selected event.
- Select the **Back** button to return to the [System Options Page](#).
- Select **Print** to print the system log.
- Select **Export** to export the system log. The system displays the [Export Page](#).

Manage Rotors Page

Figure 6.46 Manage Rotors Page



To add or delete rotors from your rotor library, select the **Manage Rotors** button on the System tab of the [System Options Page](#) to display the **Manage Rotors** page. See [Managing Rotors](#) for more information.

In addition to the Header Bar and the Footer Bar, the **Manage Rotors** page contains the following elements:

- The rotor list displays the rotors that have been added to the library.
- Select the **Back** button to return to the [System Options Page](#).
- Select a rotor and select **Delete** to delete the rotor. The system displays a confirmation message. Select **Yes** to delete the rotor.
- Select **Add** to add a rotor to the library. The system displays the [Add to Rotor Library Page](#).

Add to Rotor Library Page

Figure 6.47 Add to Rotor Library Page

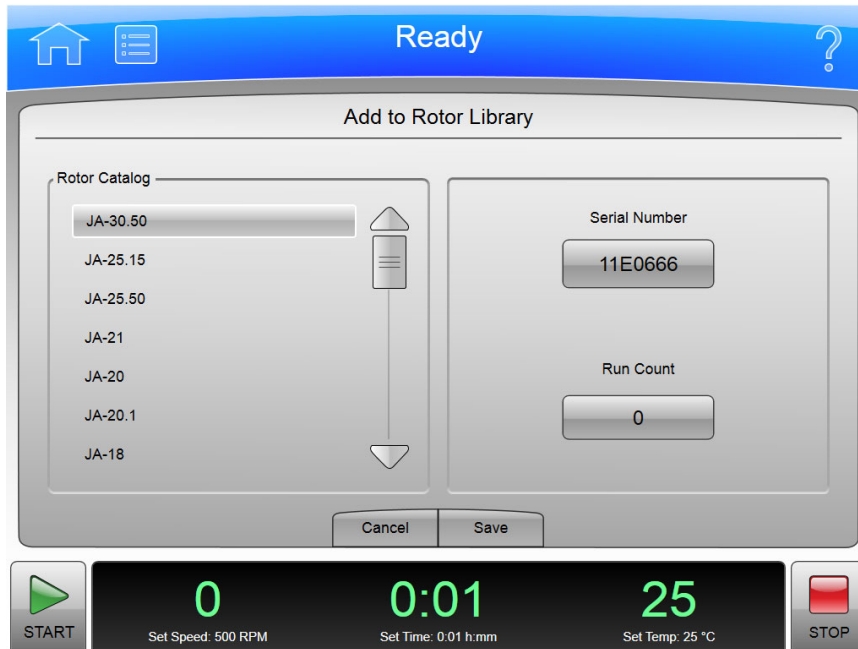

To add a rotor to your rotor library, select the **Add** button on the [Manage Rotors Page](#) to display the **Add to Rotor Library** page.

In addition to the Header Bar and the Footer Bar, the **Add to Rotor Library** page contains the following elements:

- The Rotor Catalog list on the left lists all the rotors that are compatible with the instrument. Select the type of rotor to add to the library.
- Select the **Serial Number** field to display the **Enter Serial Number** page. Enter the rotor serial number and select **OK** to return to the **Add to Rotor Library** page.
- Select the **Run Count** field to display the **Run Count** page. Enter the number of times the rotor has been used and select **OK** to return to the **Add to Rotor Library** page.
- The **Cancel** button discards your entry and returns to the [Manage Rotors Page](#).
- The **Save** button accepts your entry and returns to the [Manage Rotors Page](#).

Diagnostic History Page

Figure 6.48 Diagnostic History Page

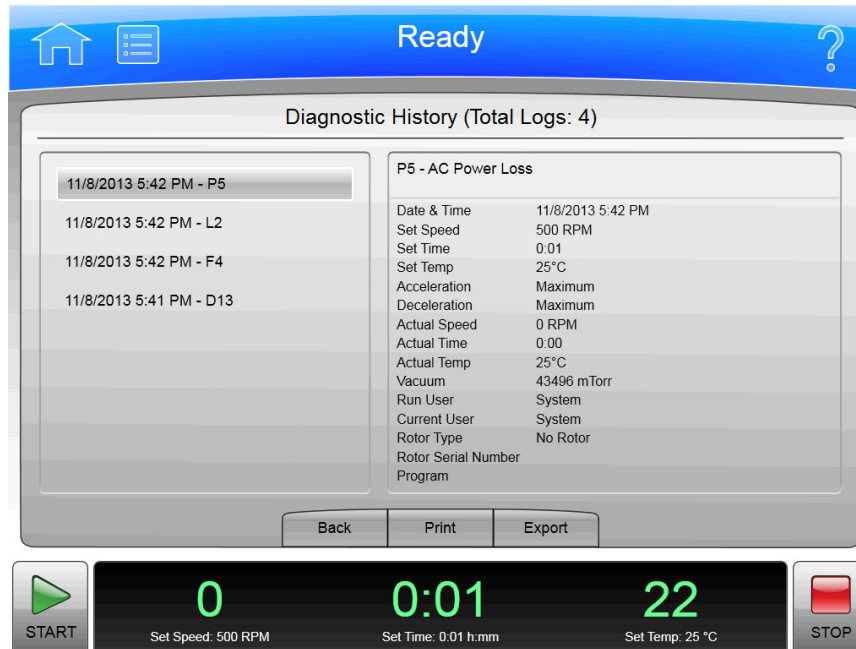

Select the **Diagnostic History** button on the System tab of the [System Options Page](#) to display the **Diagnostic History** page. Use this page to review and export the details of incidents that caused a diagnostic message on the instrument (warnings and error messages).

In addition to the Header Bar and the Footer Bar, the **Diagnostic History** page contains the following elements:

- The List of Events on the left side of the screen shows all the diagnostic events for the instrument. Scroll through this list and select an event to view the detailed information about it.
- The Event Details on the right side of the screen shows detailed information for the selected event.
- The **Back** button returns to the [System Options Page](#).
- The **Print** button prints the entire diagnostic history.
- Select **Export** to export the entire diagnostic history. The system displays the [Export Page](#).

Set Sound Page

Figure 6.49 Set Sound Page

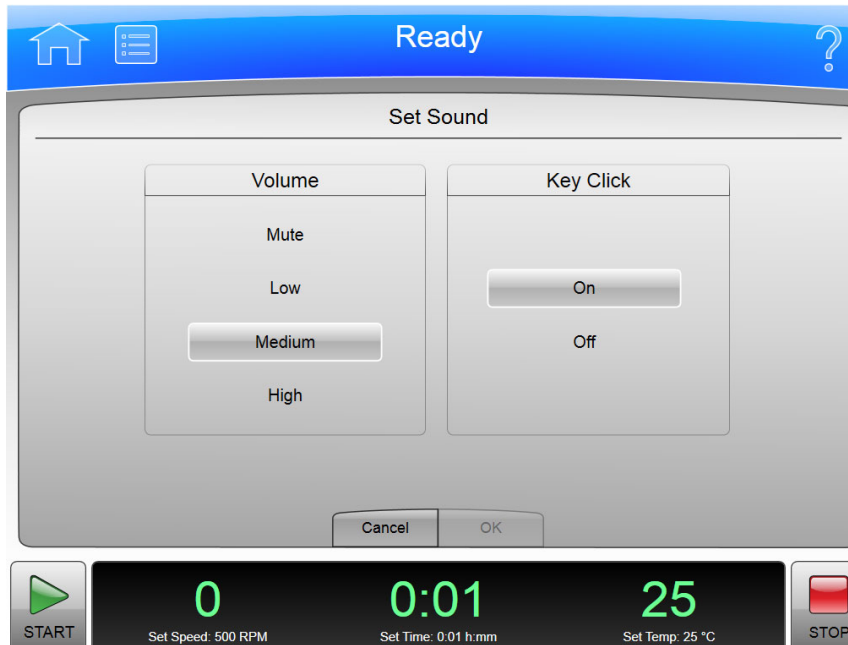

Select the **Set Sound** button on the System tab of the [System Options Page](#) to display the **Set Sound** page. Use this page to set the volume and enable or disable the key click option.

In addition to the Header Bar and the Footer Bar, the **Set Sound** page contains the following elements:

- The **Volume** buttons determines one of the four system volumes: **Mute (silent)**, **Low**, **Medium**, or **High**.
- The **Key Click** buttons set the key click (an audible sound for every screen touch) **On** or **Off**.
- The **Cancel** button discards your changes and returns to the [System Options Page](#).
- The **OK** button accepts your changes and returns to the [System Options Page](#).

Custom Sounds Page

Figure 6.50 Custom Sounds Page

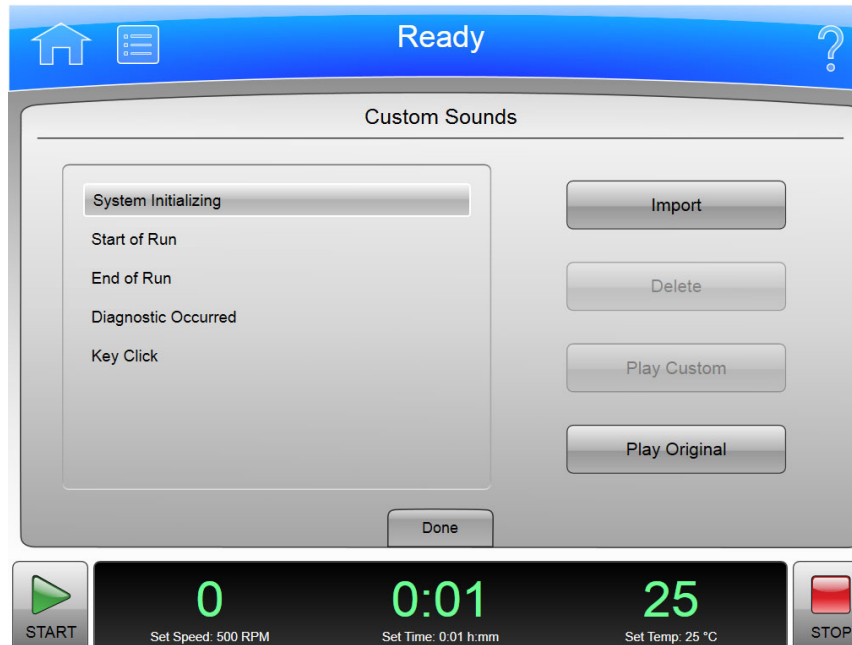

Select the **Custom Sounds** button on the System tab of the [System Options Page](#) to display the **Custom Sounds** page. Use this page to import custom sounds for various system events. See [Audible Sounds](#) for more information.

NOTE Sounds have a 10-second play limit. Files much larger than this may not be imported.

In addition to the Header Bar and the Footer Bar, the **Custom Sounds** page contains the following elements:

- The system sound list shows the system events with audible notices. Select an event to review or change the associated sound.
- Select **Import** to import a sound for the selected event from a network drive or USB device. The system displays the [Import Page](#).
- Select **Delete** to delete the sound associated with the selected event. The system displays a confirmation message. Select **Yes** to delete the sound.
- Select **Play Custom** to play the custom sound associated with the selected event.
- Select **Play Original** to play the original sound associated with the selected event.
- Select the **Done** button to return to the [System Options Page](#).

Archive Data Page

Figure 6.51 Archive Data Page

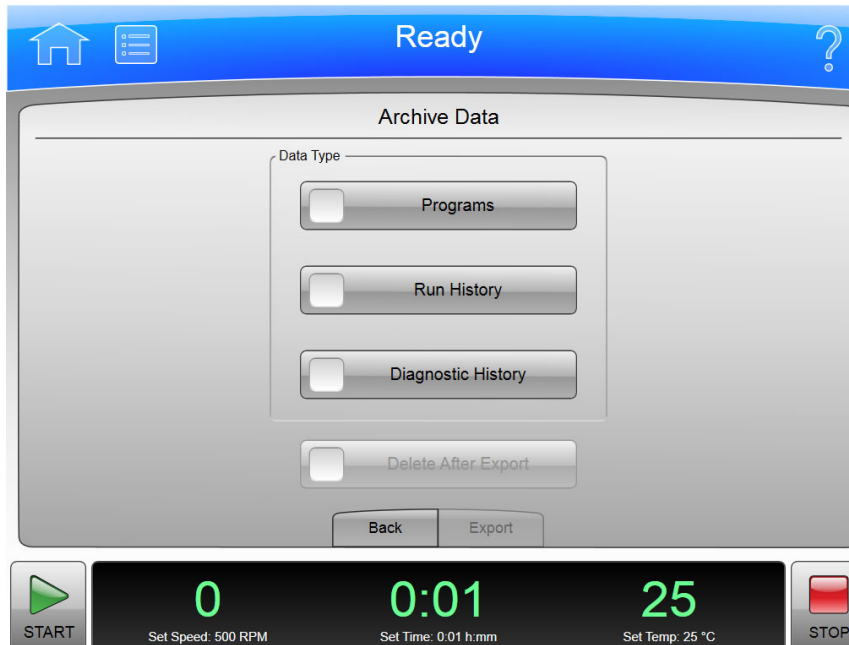

Select the **Archive Data** button on the System tab of the [System Options Page](#) to display the **Archive Data** page. Use this page to configure export of different types of system information.

NOTE Run History and Diagnostic History cannot be imported back into the system.

- The **Programs** button enables and disables run program export.
- The **Run History** button enables and disables export of run logs.
- The **Diagnostic History** button enables and disables the export of diagnostic messages.
- The **Delete After Export** button is available only when you select all three data types. Select this button to delete the information after it has been exported.
- The **Back** button returns to the [System Options Page](#).
- Select **Export** to export the selected information. The system displays the [Export Page](#).

Setup Network Page

Figure 6.52 Setup Network Page

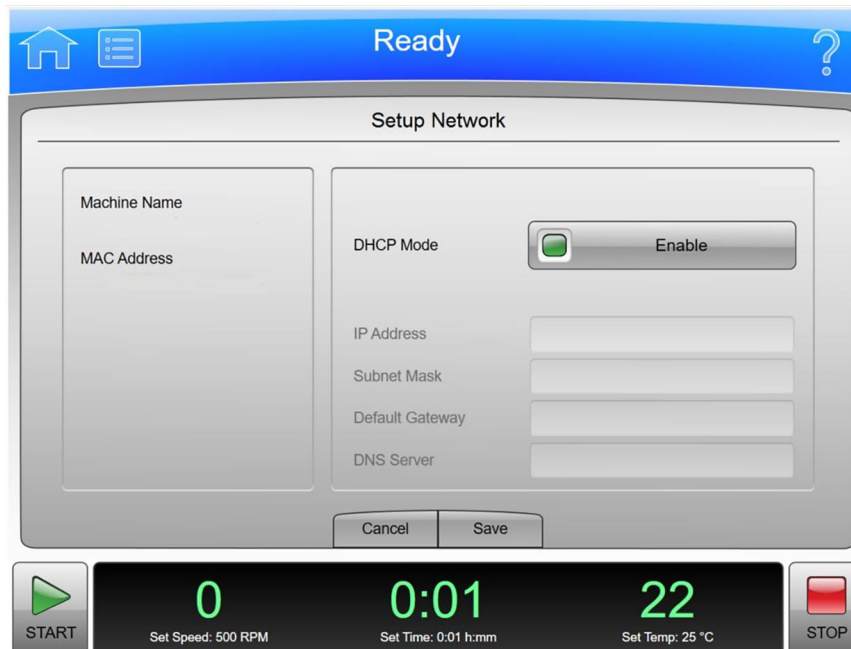

Select the **Setup Network** button on Network tab of the [System Options Page](#) to display the **Setup Network** page. Use this page to configure the network connection.

In addition to the Header Bar and the Footer Bar, the **Setup Network** page contains the following elements:

- **DHCP Mode** (Dynamic Host Configuration Protocol) is enabled by default and automatically uses a DHCP Server on the network to retrieve IP address values. If your network administrator provides a specific IP address, disable DHCP mode and enter the values provided for the following fields:
 - **IP Address**
 - **Subnet Mask**
 - **Default Gateway**
 - **DNS Server**
- The **Cancel** button discards your changes and returns to the [System Options Page](#).
- The **Save** button accepts your changes and returns to the [System Options Page](#).

Setup Network Path

Figure 6.53 Setup Network Path

The screenshot shows the 'Setup Network Path' configuration screen. At the top, a blue header bar contains a home icon, a menu icon, the word 'Ready', and a question mark icon. Below this is a grey panel with the title 'Setup Network Path'. It features four input fields: 'Network Path', 'User Name', 'Password' (with masked characters), and 'Domain'. A 'Test Network Path' button is centered below the fields. At the bottom of the grey panel are 'Cancel' and 'Save' buttons. Below the grey panel is a black footer bar with a green play button labeled 'START', three green digital displays showing '0', '0:01', and '22' with labels 'Set Speed: 500 RPM', 'Set Time: 0:01 h:mm', and 'Set Temp: 25 °C' respectively, and a red stop button labeled 'STOP'.

Select the **Setup Network Path** button on the Network tab of the **Systems Options Page** to display the **Setup Network Path** page. Use the page to configure the network path access.

Some features of this instrument can support a GMP workflow with the proper network. Refer to *Optima XPN Series and Avanti JXN Series Recommended Networking Configurations Guide (C67730)* for details. Consult with your local IT department to ensure that privacy and security requirements are met.

In addition to the Header Bar and Footer Bar, the **Setup Network Path** page contains the following elements:

- **User Name** - User name used to authenticate to the server for the **Network Path**.
- **Password** - Password used to authenticate to the server for the **Network Path**.
- **Domain** - Field is optional. If specified, the domain is used to authenticate to the server for the **Network Path**.
- **Cancel** - Discards your changes and returns to the **System Options Page**.
- **Save** - Accepts your changes and returns to the **System Options Page**.

Select Printer Page

Figure 6.54 Select Printer Page

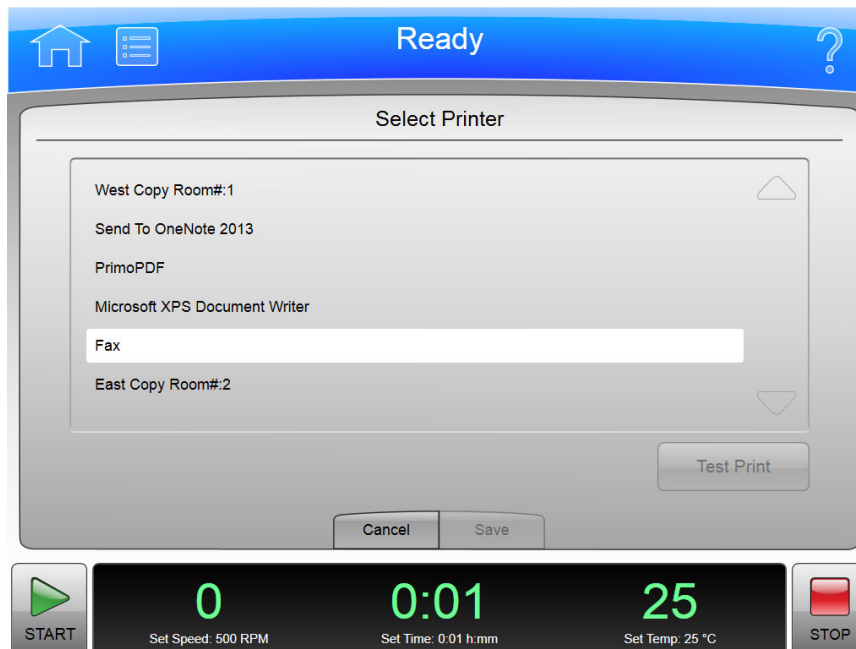

To select a printer for the system, select the **Select Printer** button on the Network tab of the [System Options Page](#) to display the Select Printer page.

In addition to the Header Bar and the Footer Bar, the **Select Printer** page contains the following elements:

- The Printer list shows the configured printers on the network or physically connected to the instrument. Printers must be configured by your Beckman Coulter Representative. Select the printer to use.
- You can select **Test Print** to send a test page to the selected printer.
- The **Cancel** button discards your selection and returns to the [System Options Page](#).
- The **Save** button accepts your selection and returns to the [System Options Page](#).

Setup Email Page

Figure 6.55 Setup Email Page

The screenshot shows the 'Setup Email' configuration page. The header bar is blue and contains a home icon, a menu icon, the text 'Ready', and a question mark icon. The main content area is titled 'Setup Email' and contains the following fields and controls:

- SMTP Server: BCI
- Port Number: 25
- User Name: (empty)
- Password: (masked with dots)
- Email From: Do.Not.Reply@avantil.beckmancoulter.com
- SSL Server: Enable
- Test Email: (button)
- Cancel: (button)
- Save: (button)

Below the form is a footer bar with a 'START' button, three status indicators (0, 0:01, 25) with their respective units (Set Speed: 500 RPM, Set Time: 0.01 h:mm, Set Temp: 25 °C), and a 'STOP' button.

Select the **Setup Email** button on the Network tab of the [System Options Page](#) to display the **Setup Email** page. Use this page to configure settings for email sent from the instrument. When email is configured, the instrument sends diagnostic notifications to all users with email addresses defined in their user profiles.

In addition to the Header Bar and the Footer Bar, the **Setup Email** page contains the following elements:

- Select the **SMTP Server** field to enter your email server name or address. Select **OK** to save the address and return to the Setup Email page.
- The **Port Number** field defaults to 25. Do not change it unless required by your email server.
- **User Name** and **Password** are optional, but may be required by your email server. Select the fields to enter the required values, then select **OK** to return to the Setup Email page.
- **Email From** defines the return email address that appears on email notifications sent by the instrument. You can change the default to a legitimate or fictitious address, depending on your requirements. Select the field to enter the new address, then select **OK** to save the address and return to the Setup Email page.
- Select the SSL Server **Enable** button to enable email encryption, if necessary. The button displays a green square when the option is enabled.
- You can select **Test Email** to send an email to test your configuration. Enter the recipient email address and select **OK** to send the email and return to the Setup Email page. The system displays a status message for the success or failure sending the test email. The email may still not be delivered to the specified recipient.
- The **Cancel** button discards your changes and returns to the [System Options Page](#).

- The **Save** button accepts your changes and returns to the [System Options Page](#).

Setup VNC Page

Figure 6.56 Setup VNC Page

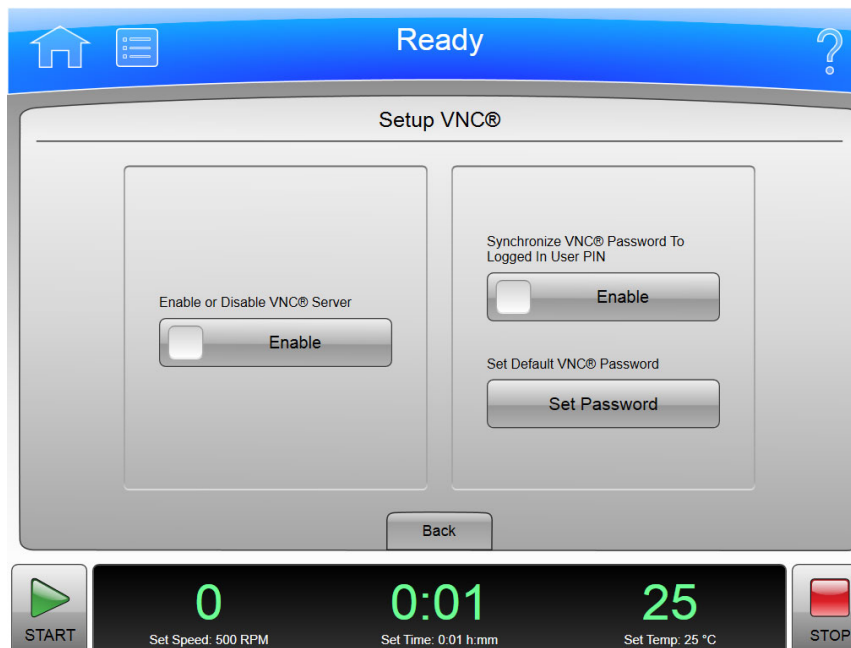

Select the Setup VNC button on the Network tab of the [System Options Page](#) to display the **Setup VNC** page. Use this page to connect to the instrument from a laptop or other remote device.

- The Enable or Disable VNC Server **Enable** button enables or disables the VNC server.
- The Synchronize VNC Password To Logged in User PIN **Enable** button enables or disables using the current user's PIN as the VNC password.
- Select the **Set Password** button to set a default password. Enter and confirm the password and select **OK** to save the password and return to the **Setup VCN** page. The system uses this password when no user is logged in.
- The **Back** button returns to the [System Options Page](#).

Manage Users Page

Figure 6.57 Manage Users Page

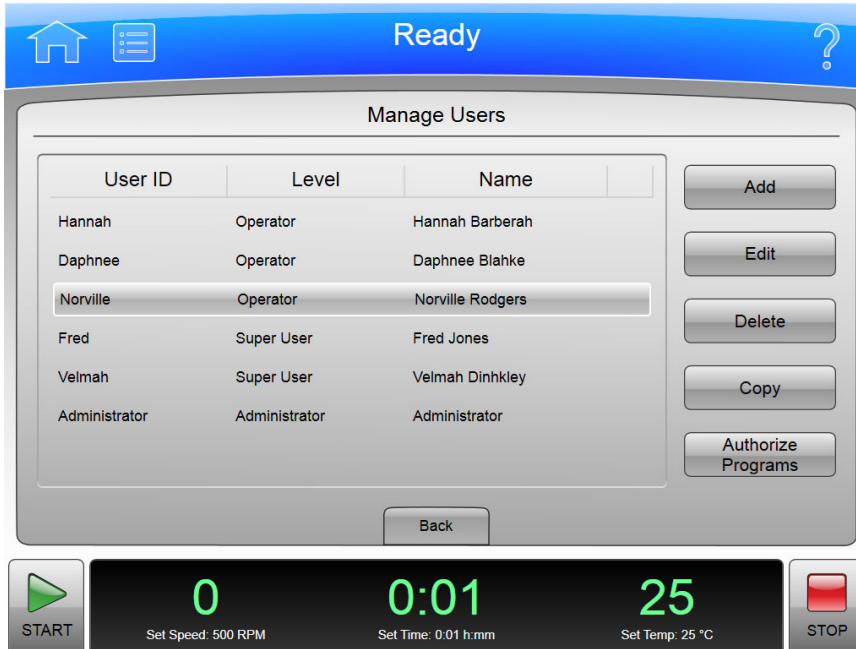

To add, delete or edit your users, select the **Program** button on the Users tab of the [System Options Page](#) to display the **Manage Users** page.

In addition to the Header Bar and the Footer Bar, the **Manage Users** page contains the following elements:

- Select **Add** to add a new user profile. The system displays the [Add User Page](#).
- Select a User ID and select **Edit** to change an existing user profile. The system displays the [Edit User Page](#).
- Select a User ID and select **Delete** to remove a user profile from the list. The system displays a confirmation message. Select **Yes** to remove the user profile. User IDs cannot be re-used.
- Select a User ID and select **Copy** to copy the user level and permissions from the selected user profile to a new user profile. This is helpful when you want to add a user with the same run program permissions as an existing user. The system displays the [Add User Page](#) with the copied information.
- Select an Operator-level User ID and select **Authorize Programs** to grant the user permission to use certain run programs. The system displays the [Authorize Programs Page](#).
- The **Back** button returns to the [System Options Page](#).

Add/Edit User Page

Figure 6.58 Add User Page

The screenshot shows the 'Add User' page on a control panel. The page has a blue header bar with a home icon, a 'Ready' status, and a help icon. The main area is titled 'Add User' and contains several input fields: 'User ID' (Fred), 'PIN' (masked with dots), 'Email' (fred.jones@mymail.com), 'Full Name' (Fred Jones), and 'Phone Number' (555-555-1212). To the right, there is a 'Select User Level' section with buttons for 'Operator', 'Super User', and 'Administrator', and an 'Authorize Programs' button. At the bottom of the form are 'Cancel' and 'Save' buttons. Below the form is a footer bar with a 'START' button, three digital displays (0, 0:01, 25), and a 'STOP' button. The displays are labeled 'Set Speed: 500 RPM', 'Set Time: 0:01 h:mm', and 'Set Temp: 25 °C'.

To add a user profile to the system, select the **Add** button on the [Manage Users Page](#) to display the **Add User** page.

To edit an existing user profile, select the User ID and select **Edit** on the [Manage Users Page](#) to display the **Edit User** page. The pages contain the same options.

In addition to the Header Bar and the Footer Bar, the **Add/Edit User** page contains the following elements:

- Select the **User ID** field to enter a User ID for a new user profile. Select **OK** to return to the **Add User** page.

NOTE Once you have saved the page, the User ID cannot be changed.

- Select the **PIN** field to set or change the PIN. Enter the new PIN in the **Enter PIN** field, and repeat the same number in the **Confirm PIN** field. Select **OK** to return to the **Add/Edit User** page.
- Select the **Email** field to enter or change the user's email. Enter or change the email address and select **OK** to return to the **Add/Edit User** page.

NOTE If the system is configured for email, all diagnostic messages will be sent to this address.

- Select the **Full Name** field to enter or change the name associated with this user profile. Enter or change the name and select **OK** to return to the **Add/Edit User** page.
- Select the **Phone Number** field to enter or change the user's phone number. Enter or change the phone number and select **OK** to return to the **Add/Edit User** page.
- Select the **User Level**. See [Managing Users](#) for more information.

- For Operator-level user profiles, you can select the **Authorize Programs** button to add permission to run programs to the user profile. The system displays the [Authorize Programs Page](#).
- The **Cancel** button discards your changes and returns to the [Manage Users Page](#).
- The **Save** button accepts your changes and returns to the [Manage Users Page](#).

Authorize Programs Page

Figure 6.59 Authorize Programs Page

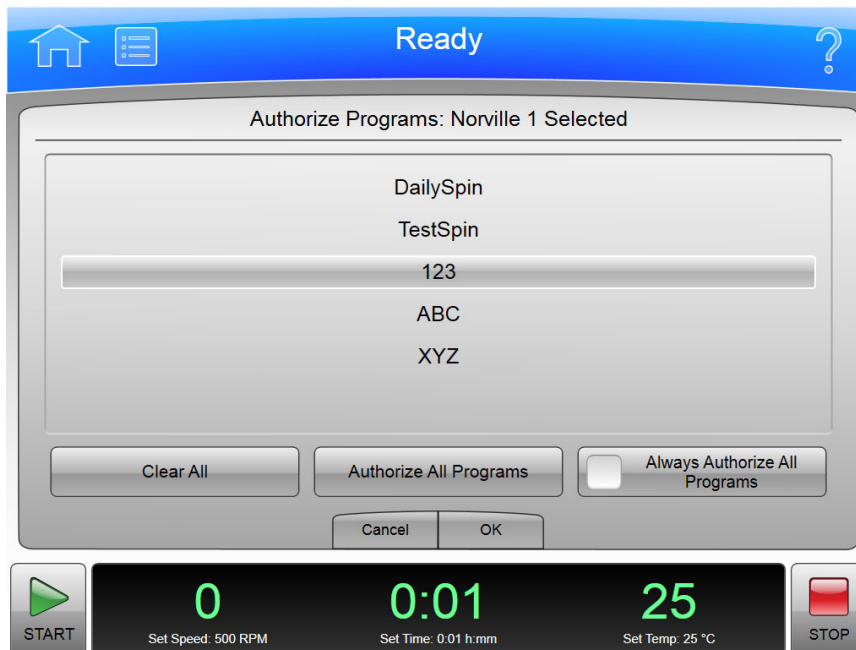

To manage the list of run programs the user has permission to run, select the User ID and select the **Authorize Programs** button on the [Manage Users Page](#), or select the **Authorize Programs** button on the [Add/Edit User Page](#) to display the **Authorize Programs** page.

In addition to the Header Bar and the Footer Bar, the **Authorize Programs** page contains:

- The User ID appears at the top of the page.
- The list box displays the programs in the system. Programs that the user has permission to run are highlighted.
- To grant the user permission to run additional programs, select the programs.
- To remove permission for all programs, select **Clear All**.
- To grant the user permission to run all programs, select **Authorize All Programs**.
- To grant the user permission to run all programs and all future programs as they are added to the system, enable **Always Authorize All Programs**.
- Select the **Cancel** button to discard your changes and return to the previous page.
- Select the **OK** button to accept your changes and return to the previous page.

Rotor Catalog Page

Figure 6.60 Rotor Catalog Page



Select the **Rotor Catalog** button on the [Menu Page](#) to display the **Rotor Catalog** page. Use this page to examine the detailed specifications for all the rotors compatible with the Avanti JXN series.

In addition to the Header Bar and the Footer Bar, the **Rotor Catalog** page contains the following elements:

- The rotor list on the left side of the screen shows compatible rotors. Scroll through this list and select a rotor to view the detailed information about it.
- The rotor details on the right side of the screen shows details for the selected rotor.
- The **Back** button returns to the **Menu** page.

About Page

Figure 6.61 About Page

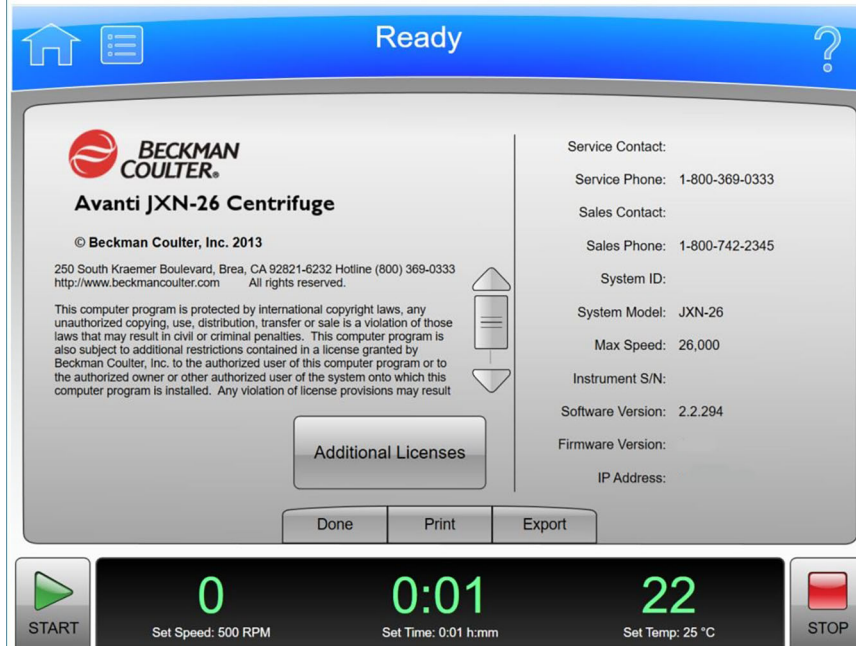

The **About** page appears when you select the **About** button on the [Home Page](#). This page presents system information about your instrument.

In addition to the Header Bar and the Footer Bar, the **About** page contains the following operating elements:

- The **Done** button dismisses the page.
- The **Print** button prints the page.
- The **Export** button displays the [Export Page](#).

Zonal Authorization Page

IMPORTANT Zonal mode is used when the JCF-Z flow/zonal rotor is installed.

Figure 6.62 Zonal Authorization Page



Select the **Zonal Mode** button on the side menu of the [Home Page](#), or the **Zonal Operation** button on the [Menu Page](#) to display the **Zonal Authorization** page. Enter the authorization code (1793) and select **Authorize** to use Zonal mode for the next run.

Figure 6.63 Zonal Mode Button



In addition to the Header Bar and the Footer Bar, the **Zonal Authorization** page contains the following elements:

- The **Cancel** button dismisses the page without entering Zonal mode.
- The **Authorize** button submits the authorization code and, if correct, displays the [Zonal Operation Page](#), which replaces the [Home Page](#) while you are using Zonal mode.

Zonal Operation Page

Figure 6.64 Zonal Operation Page

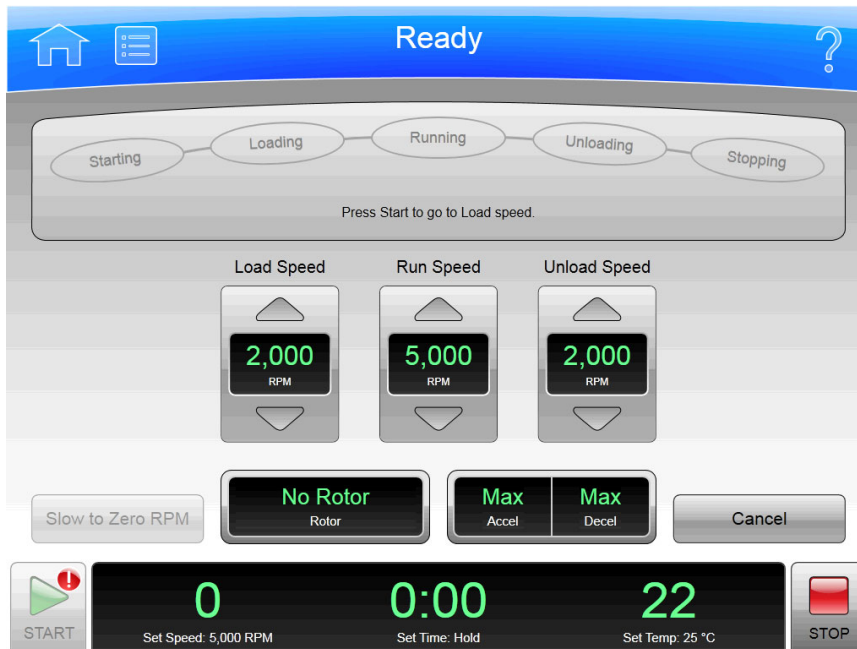

Enter the correct authorization code from the [Zonal Authorization Page](#) to display the **Zonal Operation** page and enter Zonal mode.

When you use Zonal mode, the **Zonal Operation** page replaces the [Home Page](#) until Zonal mode ends.

In addition to the Header Bar and the Footer Bar, the **Zonal Operation** page contains the following elements:

- As a display, the **Status Display/Buttons** show the current step in the Zonal or Continuous Flow run procedure. Once a run has started, the **Loading, Running, and Unloading** buttons become active and are used to move between Zonal process steps. See [Zonal and Continuous Flow Operation](#) in [CHAPTER 3, Operations](#) for additional details.
- As a display, the **Load Speed Display/Button** shows the sample loading speed. Use the arrow buttons above and below to increase or decrease the sample loading speed, or select the button to enter the sample loading speed using the keypad.
- As a display, the **Run Speed Display/Button** shows the sample running speed. Use the arrow buttons above and below to increase or decrease the sample running speed, or select the button to enter the sample running speed using the keypad.
- As a display, the **Unload Speed Display/Button** shows the sample unloading speed. Use the arrow buttons above and below to increase or decrease the sample unloading speed, or select the button to enter the sample unloading speed using the keypad.
- The **Slow to Zero RPM** button is for preliminary steps which require bringing the rotor to a stop temporarily during the initial loading adjustments. The button brings the rotor to a stop without exiting Zonal mode.

- As a display, the **Rotor Display/Button** shows the current selected rotor. Select the button to display the Select Rotor page.

NOTE Only rotors available for use with the Zonal mode will show in the list.

- As a display, the **Accel and Decel Display/Button** shows the currently selected acceleration or deceleration profile. Select the button to display the Set Acceleration/Deceleration Profiles Page.
- The **Cancel** button ends Zonal mode before loading is complete, and returns to the **Home** page. **Cancel** is available only until you start the run or select **Slow to Zero RPM**. When the run is in progress, use **Stop** to end the run and exit Zonal mode.

Use the Footer Bar for setting the run speed, time, and temperature.

Maintenance and Troubleshooting

Overview

This chapter contains care and maintenance procedures to be performed regularly.

This chapter contains information about:

- [Field Service](#)
- [Maintenance](#)
- [Decontamination](#)
- [Sterilization and Disinfection](#)
- [Replacing the Air Filter](#)
- [Checking the Vacuum Pump](#)
- [Diagnostics/User Messages](#)
- [Accessing the Rotor in Case of Power Failure](#)
- [JCF-Z Rotor Identification](#)
- [Storage and Transportation](#)
- [Supply List](#)

Field Service

For any maintenance not covered in this manual, contact your Beckman Coulter Representative for assistance. USA customers can call 1-800-742-2345. For international contacts, see the website at www.beckman.com or use the contact numbers on the inside front cover of this book.

NOTE It is your responsibility to decontaminate the instrument, as well as any rotors and accessories, before requesting service by your Beckman Coulter Representative.

Maintenance

Perform the following procedures regularly to ensure continued performance and long service life of the centrifuge.

Performing Instrument Maintenance

- 1 Inspect the centrifuge chamber for accumulations of sample, dust, or glass particles from broken sample tubes.

- a. Clean as required (see [Cleaning](#) below).
-
- 2 Check the air filter on the back panel for obstructions.
 - a. Keep vents clear and clean.
-
- 3 Wipe condensation out of the chamber between runs with a sponge or clean cloth to prevent chamber icing.
-
- 4 If chamber icing occurs, defrost the system and wipe moisture out of the chamber before use.
 - a. To defrost the system, install a rotor, set the temperature to 30°C, and start a run for 20 minutes.
(These are suggested settings that may be adjusted as appropriate for your laboratory conditions.)
 - b. Make sure that the chamber, chamber gasket, and door are dry before each run.

NOTE Before using any cleaning or decontamination methods except those recommended by the manufacturer, users should check with the manufacturer that the proposed method will not damage the equipment.

Cleaning

Cleaning the Instrument

- 1 Clean the centrifuge frequently.
 - a. Always clean up spills when they occur to prevent corrosives or contaminants from drying on component surfaces.
-
- 2 To prevent accumulations of sample, dust, and/or glass particles from broken sample tubes, keep the chamber clean and dry by frequent wiping with a cloth or paper towel.
 - a. For thorough cleaning, wash the chamber using a mild detergent such as Solution 555.
 - b. Dilute the detergent with water (10 parts water to 1 part detergent).
 - c. Rinse thoroughly and dry completely.
-
- 3 Clean the centrifuge exterior surfaces by wiping with a cloth dampened with Solution 555. Dilute the detergent with water (10 parts water to 1 part detergent). Do not use acetone.
-
- 4 Clean the drive hub regularly using Solution 555 and a soft brush.

- a. Dilute the detergent with water (10 parts water to 1 part detergent).
 - b. Rinse thoroughly and dry completely.
-

Tube Breakage

- 1 If a glass tube breaks, and all the glass is not contained in the bucket or rotor, be sure to thoroughly clean the chamber.



WARNING

Risk of possible biohazardous contamination and/or operator injury. Be careful when examining or cleaning the chamber and chamber gasket, as sharp glass fragments may be embedded in their surfaces.

- 2 Examine the chamber gasket to make sure that no glass particles are retained in it.
 - a. Carefully remove any glass particles that may remain.
-

- 3 Carefully wipe away any glass particles that remain in the chamber.
-

Decontamination

If the instrument and/or accessories are contaminated with radioactive or pathogenic solutions, follow appropriate decontamination procedures as determined by your laboratory safety officer. Refer to Chemical Resistances (publication IN-175), or contact your Beckman Coulter Representative to ensure that the decontamination method does not damage any part of the instrument (or accessories).

Sterilization and Disinfection

⚠ WARNING

While Beckman Coulter has tested these methods and found that they do not damage the instrument, no guarantee of sterility or disinfection is expressed or implied. When sterilization or disinfection is a concern, consult your laboratory safety officer regarding proper methods.

⚠ WARNING

Ethanol is a volatile liquid that cannot be used on or near an operating instrument due to fire hazard.

⚠ CAUTION

Ethanol is a flammability hazard. Do not use it in or near operating centrifuges.

Ethanol (70%) may be used to clean any exterior surface of the centrifuge. While Beckman Coulter has tested ethanol (70%) and found that it does not damage the centrifuge, no guarantee of sterility or disinfection is expressed or implied. When sterilization or disinfection is a concern, consult your laboratory safety officer regarding proper methods to use.

Replacing the Air Filter

- 1 Check the air filter regularly and replace it about once a year, or more often if it looks dirty. The air filter is not fastened to the centrifuge, so no tools are required for removal or installation.

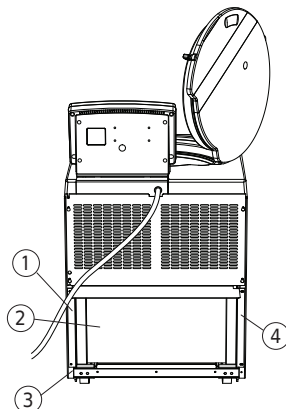

1. Frame Edge
2. Air Filter
3. Retaining Strip
4. Frame Edge

- 2 To remove the air filter, hold the side edges and lift the filter straight up until the bottom edge is above the centrifuge bottom retaining strip.
 - a. Pull the filter out, bottom edge first, and discard it.
- 3 Install a new filter.
 - a. The filter has a directional arrow on one of its edges; install the filter with this arrow pointing toward the centrifuge.
 - b. Holding the filter by the side edges, insert the top half behind the frame edge and lift up until the bottom half clears the retaining strip.
 - c. Then, set the bottom edge down.

Checking the Vacuum Pump

IMPORTANT An oil level check is only applicable to the Avanti JXN-30 instrument.

Check the vacuum pump oil level at approximately every 1000 cycles. To access the vacuum pump, you must remove the centrifuge front panel. The pump is on the bottom lower left of the centrifuge housing, with the view shown in [Figure 7.1](#) facing out.

Figure 7.1 Front View of Vacuum Pump

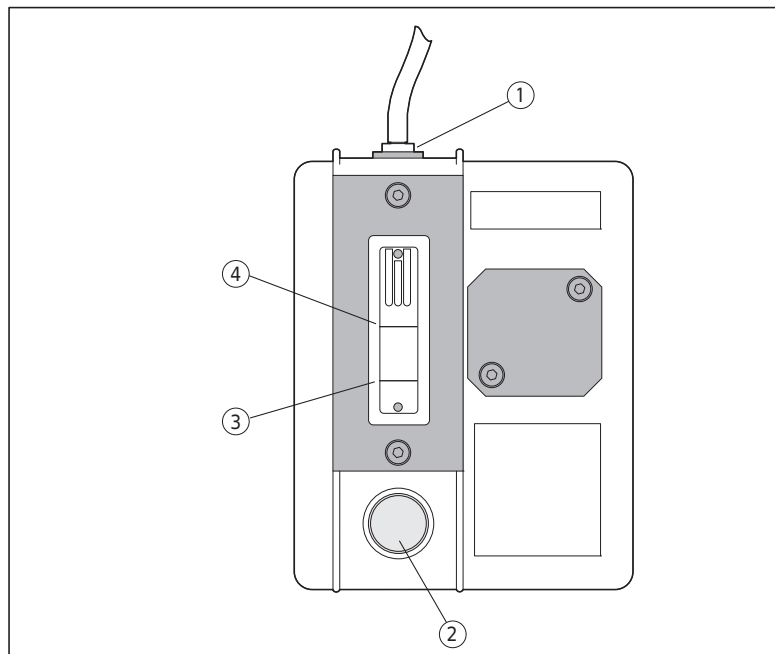

- | | |
|---------------|----------------------|
| 1. Filter Cap | 3. Minimum Fill Line |
| 2. Drain Plug | 4. Maximum Fill Line |

- 1 Remove the centrifuge front panel.
See [Accessing the Rotor in Case of Power Failure](#) for instructions.
- 2 Unscrew the filler cap. Set the cap aside.
- 3 Add oil (PN 392760) up to the maximum fill line. Pour the oil through a funnel if necessary.
- 4 Screw the filler cap back on tightly.
- 5 Replace the front panel. See [Replacing the Front Panel on the Centrifuge](#) for instructions.

Diagnostics/User Messages

When a condition arises that requires operator attention, the header bar turns yellow or red. A page displays the diagnostic message. User messages communicate information about the centrifuge or alert you to an abnormal condition. For a list of the possible malfunctions and their corrective actions, see [APPENDIX C, Diagnostics](#).

Accessing the Rotor in Case of Power Failure

WARNING

Any maintenance procedure requiring removal of a panel exposes the operator to the possibility of electrical shock and/or mechanical injury. Therefore, turn the power off (O) and disconnect the instrument from the main power source by removing the Mains (power) plug from the outlet receptacle, and refer such maintenance to qualified service personnel.

WARNING

Before performing this procedure, verify that the rotor is not spinning by listening carefully for any noise coming from the chamber. Proceed only if the instrument is quiet. Never attempt to override the door interlock system while the rotor is spinning.

If the facility power fails only momentarily, the centrifuge will resume operation when the power is restored and the rotor will return to the set speed. In the event of an extended power failure,

you may need to override the door-locking mechanism manually to remove the rotor and retrieve your sample.

To access the door-locking mechanism, you must remove the instrument front panel. Two latches secure the front panel in place; these latches are accessible through two holes at the upper right and left of the panel (see [Figure 7.2](#)).

Figure 7.2 Emergency Door Release Latch Access

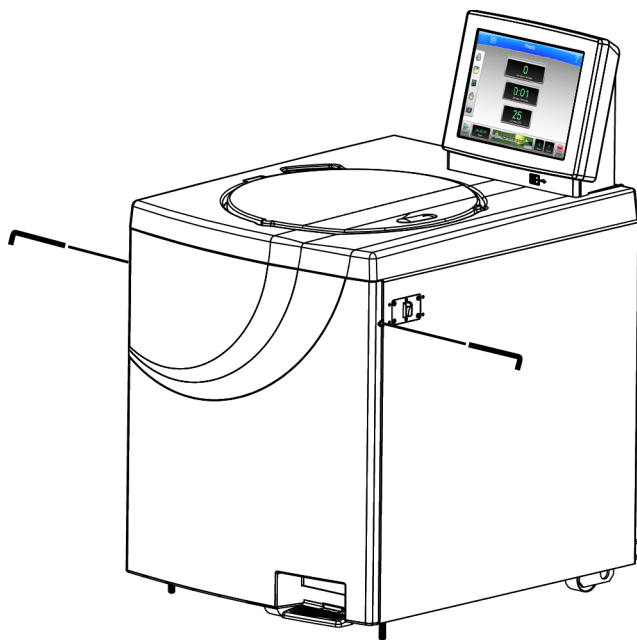

- 1** Turn the power switch to off (O) and unplug the power cord from the main source by removing the Mains (power) plug from the outlet receptacle.
 - The Mains (power) plug is the disconnect device and must remain easily accessible.
 - Position the centrifuge so that it is easy to remove the Mains (power) plug from the outlet receptacle.
- 2** Insert a 4-mm or $5/32$ -in. Allen wrench straight through one of the holes (either one) and turn the wrench to the left (counterclockwise) until the latch disengages.
- 3** Repeat step 2, inserting the Allen wrench through the other hole.
 - After the second latch disengages, the front panel will fall forward about an inch from the top.
 - The bottom of the front panel is held in place by three grooved brackets, attached to the front panel, that seat over a metal retaining strip on the centrifuge bottom panel.

- 4** Lift the front panel up and off the centrifuge; set it aside.
 - You will see an inner front panel that extends about halfway down from the centrifuge top (see [Figure 7.3](#)).
 - Below this inner panel is a black manual door release interlock lever (see [Figure 7.3](#)).

Figure 7.3 Manual Door Release

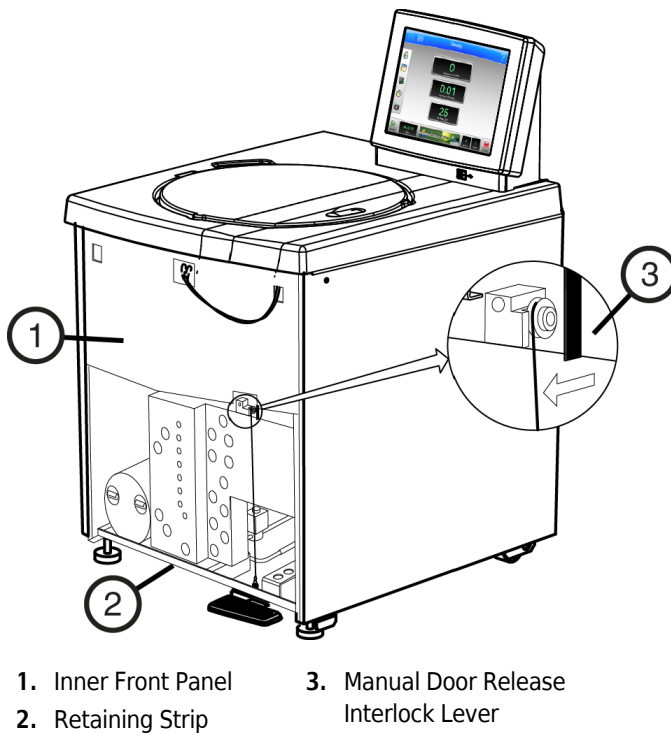

- 5** Pull the interlock lever out and to the left (at about a 45-degree angle), and while holding it out, step on the foot pedal.

Depending on the level of vacuum in the chamber at the time of the power failure, the door may or may not open.

 - a.** If it opens, go to step [6](#).
 - b.** If it does not open, you will need to manually vent the vacuum. Go to step [7](#).
- 6** After the door opens, first release the foot pedal and then release the interlock lever.

Sample can be removed.

 - a.** Go to step [10](#).
- 7** To vent the chamber vacuum, grasp either one of the two red rubber hoses, and pull it up until it comes off of the pump fitting (see [Figure 7.4](#)).

Use a back-and-forth motion as you pull; this takes quite a bit of force.

The vacuum will be completely vented several seconds after the hose is detached.

NOTE Several tubing lines are tied to the red hose. As you grasp the hose, place your hand over these lines. Make sure that they stay connected as you pull.

CAUTION

Risk of instrument damage. Do not twist the hose to the left (counterclockwise) as you pull the hose, or you will unscrew the hose fitting.

Figure 7.4 Venting the Chamber Vacuum - Removing the Red Hose

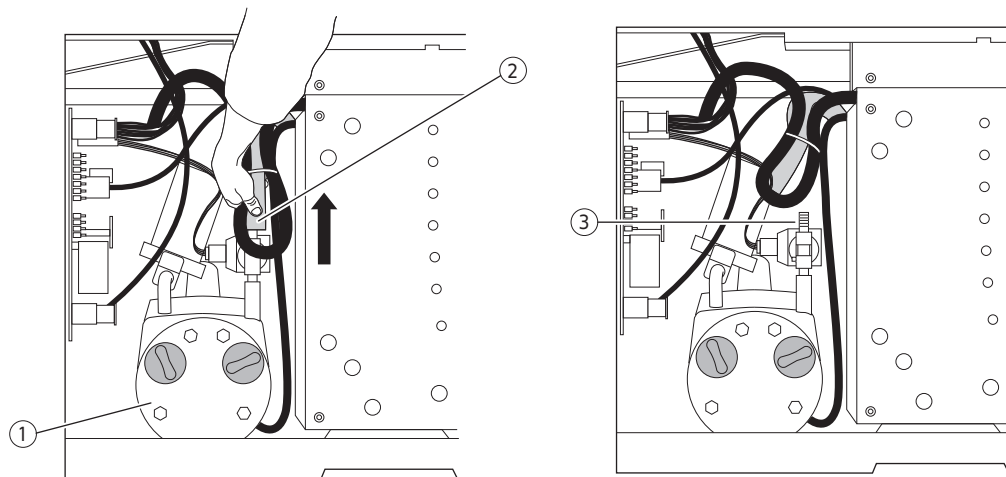

- 1. Vacuum Pump
- 2. Red Hose

- 3. Pump Fitting

-
- 8 Replace the hose by pushing it down over the fitting as far as it can go (see [Figure 7.5](#)).

Figure 7.5 Venting the Chamber Vacuum - Replacing the Red Hose

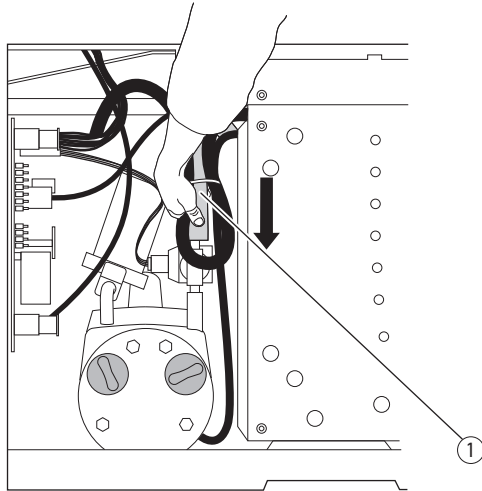

1. Red Hose

-
- 9 Pull the interlock level out and left, and while holding it out, step on the foot pedal.



Risk of serious injury or death to the operator. Never try to slow or stop the rotor by hand. Always wait for the rotor to come to a complete stop before attempting to access the sample.

-
- 10 Remove your sample.
-

Replacing the Front Panel on the Centrifuge

- 1 Holding the panel at the top (with the instrument label facing out), insert the three grooved brackets on the bottom inside of the door over the front panel retaining strip (see [Figure 7.6](#)).
 - a. Push the top of the front panel into place.

Figure 7.6 Front Panel Retaining Strip

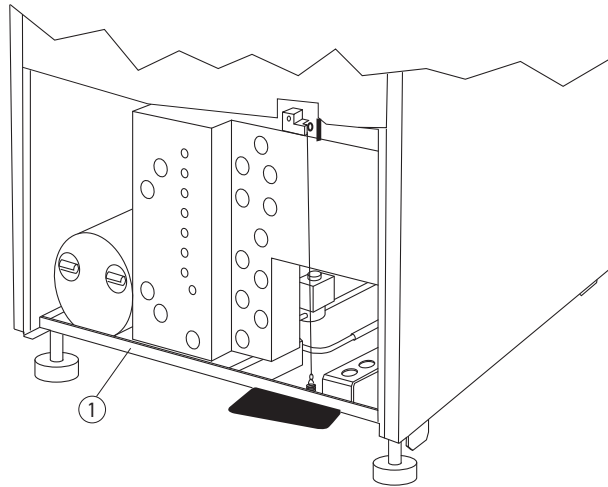

1. Retaining Strip

- 2 Hold the left top edge in place and insert the Allen wrench through the hole.
 - a. Turn to the right (clockwise) until the latch engages.
- 3 Repeat step 2 on the right side
The second latch engages.

JCF-Z Rotor Identification

The rotor identification system can, under two specific conditions, misidentify the JCF-Z continuous flow/zonal rotor. If the rotor is misidentified, the run will be stopped. Follow the steps below to resolve the issue.

NOTE Misidentification can be prevented by returning your JCF-Z rotor to the Beckman Coulter factory to have magnets added to the rotor body. The magnets ensure correct identification. Call your local Beckman Coulter Representative* for more information.

JCF-Z rotors manufactured after March, 1997, have factory-installed magnets.

* In the United States, call 1-800-742-2345. Outside the U.S., contact your local Beckman Coulter office or visit us at www.beckman.com.

- 1 *On the first few uses of a new JCF-Z rotor, or in an older JCF-Z rotor with newly replaced bearings, run the rotor from 0 to 5000 RPM and back to 0 RPM three times.*

This procedure will dis-tribute lubricant around the bearings in the rotating seal assembly, reducing drag.

- 2 *In older JCF-Z rotors with bearings that have not been replaced recently, follow the same procedure as for a new JCF-Z rotor (per-form three runs from 0 to 5000 RPM and back to 0 RPM) to ensure that the bearings are properly lubricated.*

If misidentification recurs after the third run, when the bearings are lubricated, this indicates that the bearings are worn and need to be replaced.

- a. Replace the bearings following the instructions in the JCF-Z manual (JCFZ-IM).

NOTE If the JCF-Z rotor is misidentified, the run will be stopped.

Storage and Transportation

To ensure that the instrument does not get damaged, contact your Beckman Coulter Representative for specific instructions and/or assistance in preparing the equipment for transport or long-term storage.

Supply List

Contact Beckman Coulter Sales for assistance ordering parts and supplies. Customers in the United States call 1-800-742-2345. For international contacts, see the website at www.beckman.com or use the contact numbers on the inside front cover of this book. A partial list of supplies is given below for your convenience. See the Beckman Coulter *High Performance Rotors, Tubes & Accessories* catalog (BR-8102, available at www.beckman.com) for detailed information on ordering rotors, tubes, and accessories.

Replacement Parts and Supplies

Table 7.1 Replacement Parts

Description	Part Number
Air filter	885218
Solution 555 (1 qt)	339555
Avanti JXN-30 Zonal Bracket Kit for Cole-Parameter size 16 tubing (6.4-mm [1/4-in.] O.D.)	363843
Zonal Bracket (qty 1)	363818

Table 7.1 Replacement Parts

Description		Part Number
	Thumbscrew, stainless steel, M4 (threads) X 19 mm (qty 2)	893412
	Thumbscrew, stainless steel, M4 (threads) X 12 mm (qty 2)	893411
	Cable Clamp, nylon, 6.4-mm (1/4-in.) I.D. (qty 10)	000499
Avanti JXN-26 Zonal Bracket Kit for Cole-Parameter size 16 tubing (6.4-mm [1/4-in.] O.D.)		366431
	Zonal Bracket (qty 1)	366430
	Thumbscrew, stainless steel, M4 (threads) X 19 mm (qty 2)	893412
	Thumbscrew, stainless steel, M4 (threads) X 12 mm (qty 2)	893411
	Cable Clamp, nylon, 6.4-mm (1/4-in.) I.D. (qty 10)	000499
Zonal Tubing Adapter for Cole-Parmer size 14 tubing (4.8-mm [3/16-in.] O.D.) NOTE Kit 366431 for the Avanti JXN-26 or kit 363843 for the Avanti JXN-30 is also required.		363844
	Tubing Adapter, stainless steel, for size 14 tubing (qty 2)	363830
	Cable Clamp, nylon, 4.8-mm (3/16-in.) I.D. (qty 10)	003343
Zonal Tubing Adapter for Cole-Parmer size 15 tubing (9.6-mm [3/16-in.] O.D.) NOTE Kit 366431 for the Avanti JXN-26 or kit 363843 for the Avanti JXN-30 is also required.		363845
	Tubing Adapter, stainless steel, for size 15 tubing (qty 2)	363831
	Cable Clamp, nylon, 9.6-mm (3/8-in.) I.D. (qty 10)	000596
External HEPA Filter Assembly NOTE Accessory HEPA filter Kit B37916 is required.		B45269

Preinstallation Requirements

Preinstallation Requirements

Do not attempt to install this instrument. Its purchase price includes installation by Beckman Coulter personnel. Installation by anyone other than an authorized Beckman Coulter Representative invalidates any warranty covering the instrument.

Preinstallation requirements have been sent prior to shipment of the instrument. The following information is provided in case the centrifuge must be relocated.

The centrifuge will be installed upon initial purchase by your Beckman Coulter Representative after preinstallation requirements for power and site preparation have been met. The following equipment is required for preinstallation:

- Voltmeter
- For single phase centrifuges: two 30-ampere circuit breakers
- For three phase centrifuges: three 16-ampere circuit breakers
- Power receptacle (see [Figure A.1](#) or [Figure A.2](#))

Electrical Requirements

Power to the centrifuge should originate directly from a main power line transformer at a power source known to be clear of erratic loads, spikes, and electromagnetic interference. Make sure that there are properly rated thermal circuit breakers at the service panel to protect the centrifuge circuit. If fuses must be used instead of the specified circuit breakers, the fuses may require a rating of greater than 30 amperes (for single-phase centrifuges) or greater than 16 amperes (for three-phase centrifuges).

Terminate the open end of the harmonized cord with a certified single- or three-phase connector suitable for the power supplied in the country of intended use (see [Table A.1](#)). Install only one centrifuge per circuit.

Table A.1 Nominal Supply Voltage Ratings for the Avanti JXN Series

Nominal Instrument Voltage Rating	Nominal Supply Frequency	Power Cord and Plug Description
Single-phase, 200/208/240 V	180 – 264 V, 50/60 Hz, 30 A	permanently attached three-wire UL/CSA-approved cord with NEMA type 6-30P plug

Table A.1 Nominal Supply Voltage Ratings for the Avanti JXN Series

Nominal Instrument Voltage Rating	Nominal Supply Frequency	Power Cord and Plug Description
Single-phase, 230 V	180 – 264 V, 50 Hz, 30 A	permanently attached three-wire CEN-ELEC harmonized cord without plug
Three-phase, 220/380 V + Neutral ^a	313 – 457 V, plus neutral, 50 Hz, 16 A	permanently attached five-wire CENELEC harmonized cord without plug

a. Unbalanced three-phase. Split for single-phase operation internally.

To ensure optimal safety, the centrifuge should be wired to a remote emergency switch (preferably outside the room where the centrifuge is housed, or adjacent to the exit from that room). In case of a malfunction, the centrifuge can be disconnected from the main power source by removing the Mains (power) plug from the outlet receptacle.



To reduce the risk of electrical shock, this equipment uses a three-wire or five-wire electrical cord and plug to connect the centrifuge to earth-ground. To preserve this safety feature, make sure that the matching wall outlet receptacle is properly wired and earth-grounded.

Prior to instrument purchase, the power configuration should be determined and the appropriate instrument ordered.

Single and Three-Phase Power Connections

[Figure A.1](#) shows the power connection for single-phase centrifuges, including earth-ground and two power leads with 30-ampere circuit breakers. [Figure A.2](#) shows the power connection for three-phase centrifuges, including earth-ground and three power leads with mini-mum 16-ampere circuit breakers and common neutral connection. [Table A.2](#) contains wiring information.

Figure A.1 Single-Phase Electrical Requirements

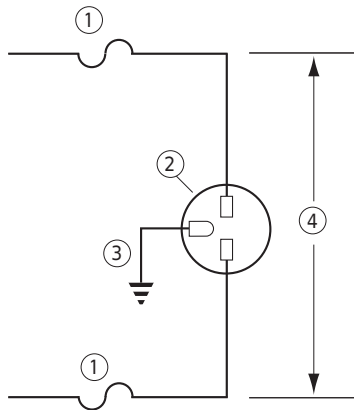

- 1. 30-ampere Circuit Breaker
- 2. Wall Outlet: Hubell 9930, Bryant 96-30-FR, or Equivalent (NEMA 6-30 R)
- 3. Earth-Ground
- 4. Measured Line Voltage

Figure A.2 Three-Phase “Y” Electrical Requirements

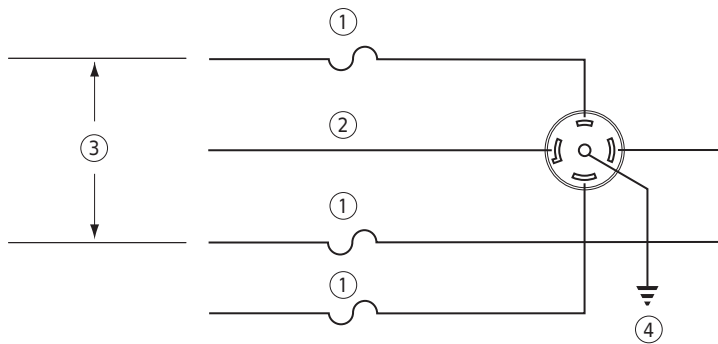

- 1. 16-ampere Circuit Breaker
- 2. Neutral
- 3. Measured Line Voltage Phase to Phase
- 4. Earth-Ground

Table A.2 Required Wire Connections

Wire Insulation Color	Terminal	Symbol	
		Harmonized	North American
Green/Yellow	Earth ground		
Light Blue	Neutral	N	L
Brown	Live or Line	L	L
Black (three-phase connections only)	Live or Line (qty 2)	L	—

Additional Requirements for Three-Phase Power Connections

For three-phase power service to the centrifuge, use the “Y” connected configuration shown in [Figure A.3](#). Also note the following information:

- The steady state current draw of the centrifuge can be as high as 12 amperes per phase, depending on the voltage.
- Inrush current to the centrifuge is 100 amperes for up to 2 seconds during the refrigeration start period. Circuit breakers, whether thermal or magnetic actuating, must be a “motor start” delay type.
- The centrifuge can tolerate a drop of 15 volts during the start period at low line voltage (see [Figure A.3](#) for the acceptable volt-age ranges). The mains power for the centrifuge must be of sufficient wire gauge to provide this condition. The wire gauge required at a particular site must be determined by a facilities engineer at that site.

Figure A.3 Correct and Incorrect Three-Phase Power Configurations

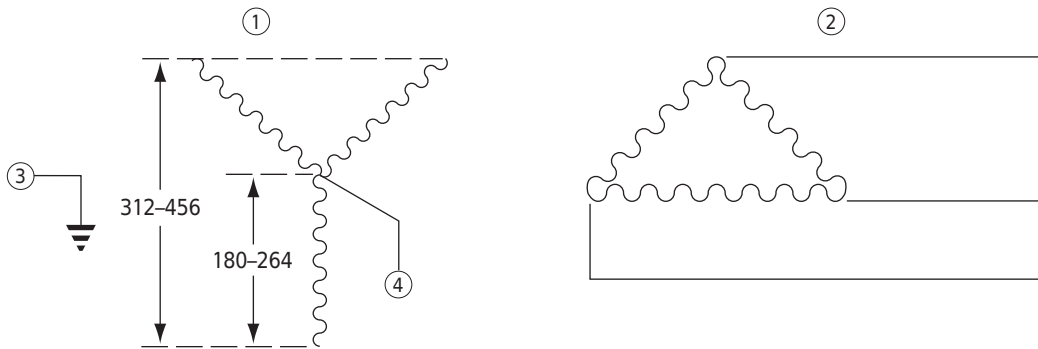

1. Correct Configuration “Y”
2. Incorrect Configuration “Delta”
3. Safety Ground
4. Circuit Common (Neutral)

Space and Location Requirements

- 1 Locate the instrument on a clean, level floor.
 - The Mains (power) plug is the disconnect device and must remain easily accessible.
 - Position the centrifuge so that it is easy to remove the Mains (power) plug from the outlet receptacle.
- 2 Select a location away from heat-producing laboratory equipment.
If ambient temperature exceeds 38°C (100°F), premature component failure may result.
- 3 In addition to space for the centrifuge, allow a 7.7 cm (3-in.) clearance on each side of the centrifuge and a 16 cm (6.25-in.) clearance behind the centrifuge for air circulation.

The centrifuge must have adequate air ventilation to ensure compliance to local requirements for vapors produced during centrifuge operation.

 **WARNING**

Do not place the centrifuge near areas containing flammable reagents or combustible fluids. Vapors from these materials could enter the instrument's air system and be ignited.

Using J2 Series Rotors in the Avanti JXN Series

 **CAUTION**

Do not use the Beckman Coulter JA-10, JS-7.5, or JA-14 rotors in the Avanti JXN centrifuge before reading this information.

Checking for Rotor Drive Pins

Rotors used in the Avanti JXN series centrifuges must have drive pins in the rotor drive hole (see [Figure A.4](#)). These drive pins engage with the centrifuge spindle hub to ensure that the rotor does not slip during acceleration. Some Beckman Coulter rotors, including the JA-10, the JS-7.5, and the JA-14, have been manufactured without drive pins because pins were not needed when these rotors were used in J2 series centrifuges.

Figure A.4 Checking the Rotor for Drive Pins

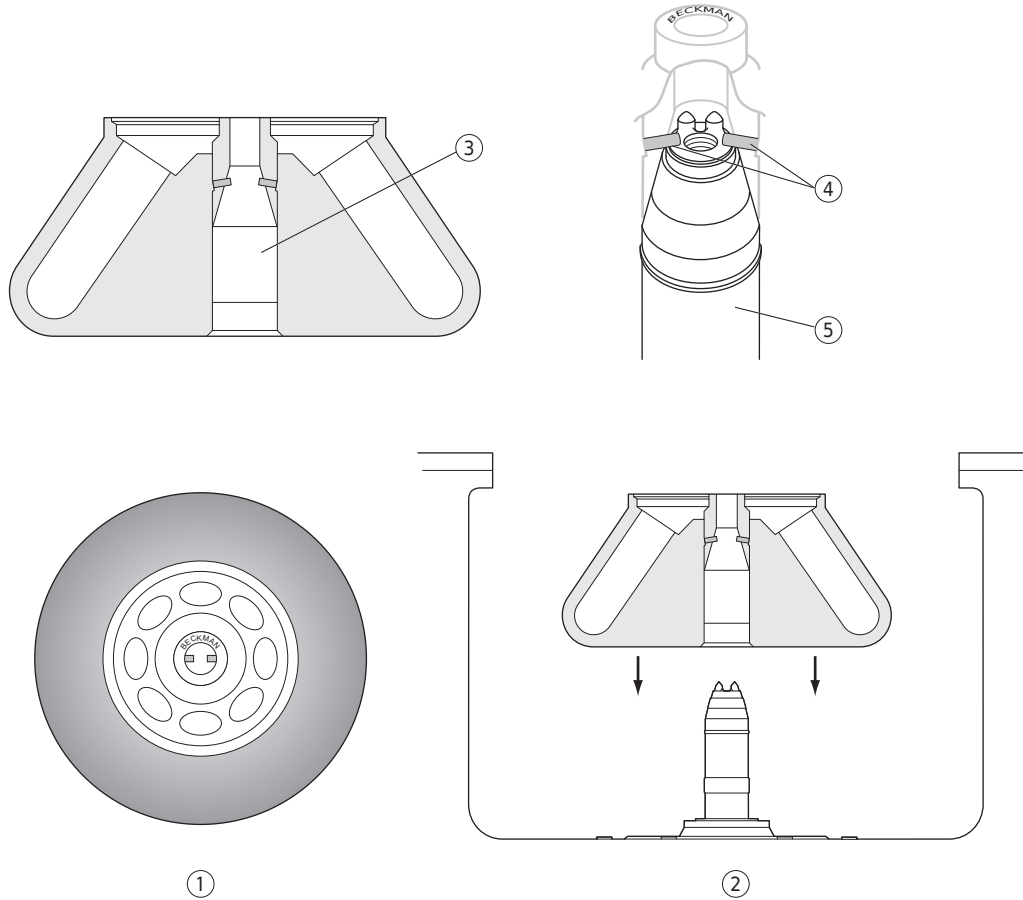

1. Top View
2. Side View
3. Rotor Drive Hole
4. Drive Pins
(Angled pins shown; pins can also be vertical or horizontal.)
5. Drive Spindle Assembly

The rotor pins are positioned parallel to the **Beckman** name engraved at the center of the rotor body (see [Figure A.4](#)). Knowing the pin orientation before you install the rotor will help to ensure that you position the rotor properly on the hub, minimizing the chance of hub damage.

Check all J2 series rotors for drive pins before using them in an Avanti JXN series centrifuge and do not use rotors without drive pins in the Avanti JXN series. To check for drive pins, hold the rotor up or turn it on its side and look into the drive hole. If you do not see two metal pins in the hole, do not use the rotor in the Avanti JXN series. Call your local Beckman Coulter office for information on returning the rotor to the factory for upgrading.*

* In the United States, call 1-800-742-2345. Outside the U.S., contact your local Beckman Coulter office or visit us at www.beckman.com.

Using the JCF-Z Continuous Flow/Zonal Rotor

Zonal Bracket Kits

A special bracket and mounting hardware are required when the JCF-Z Continuous Flow/Zonal Rotor is used. These parts are contained in the Zonal Bracket Kit. The Zonal Bracket Kit includes a bracket, mounting hardware, and assembly instructions. This kit is for use with Cole-Parmer tubing size 16 (6.4 mm [$1/4$ -in.] O.D.), the tubing size most commonly used with the JCF-Z rotor.

Two additional kits are available, one which contains adapters for size 14 tubing (4.8 mm [$3/16$ -in.] O.D.) and one which contains adapters for size 15 tubing (9.6 mm [$3/8$ -in.] O.D.). If you wish to use either of these sizes of tubing, you will need to purchase one of these kits in addition to the basic kit.

See [Table 7.1](#) in [CHAPTER 7, Maintenance and Troubleshooting](#) for a complete list of Zonal Bracket Kit contents.

Preinstallation Requirements

Using J2 Series Rotors in the Avanti JXN Series

Temperature Calibration Procedure

Introduction

The Avanti JXN series centrifuge specification for temperature control is $\pm 2^{\circ}\text{C}$. The following procedure is provided for those cases in which temperature control within $\pm 1^{\circ}\text{C}$ is required.

In this procedure, you will measure the temperature of your sample after equilibrating the rotor temperature for a minimum of 1 hour. Based on the test results, you can then adjust the centrifuge temperature setting to bring your sample as close as possible to the required temperature.

Calibrating Temperature

- 1 For runs at other than ambient temperature, precool or prewarm the rotor and test samples to the required temperature.

The length of precooling/prewarming time depends on how different the rotor starting temperature is from the required run temperature.

- 2 Install the rotor with adapters, if applicable, and tubes or bottles filled with sample buffer or water (if above 2°C).
-

- 3 Set the speed to 2000 RPM, the time to **HOLD**, and the temperature to the required run temperature.

- a. Start the run.

- 4 After 30 minutes, set the required run speed, and allow the system to run for at least 1 hour.

NOTE *The system must run for at least 1 hour before the temperature of the buffer or water is measured.* The length of time required for equilibration depends on the rotor and centrifuge starting temperatures and the ambient room temperature.

- 5 After at least 1 hour, measure the temperature of the buffer or water using a thermometer or thermocouple.
-

- 6 If the measured and set temperatures are different, note how many degrees different they are and adjust the set temperature up or down that number of degrees.

For example:

If the required sample temperature is	And the measured buffer/water temperature is	Set the temperature to
4°C	6°C	2°C
5°C	4°C	6°C

Overview

This section lists possible malfunctions and corrective actions. Maintenance procedures are described in [CHAPTER 7, Maintenance and Troubleshooting](#).

For any maintenance not covered in this manual, contact your Beckman Coulter Representative for assistance. USA customers can call 1-800-742-2345. For international contacts, see the website at www.beckman.com or use the contact numbers on the inside front cover of this book.

NOTE It is your responsibility to decontaminate the centrifuge, as well as any rotors and/or accessories, before requesting service by your Beckman Coulter Representative.

Diagnostics/User Messages Chart

Refer to the chart below for a list of possible malfunctions and their corrective actions.

Table C.1 Diagnostics/User Messages Chart

Message	Definition/Result	Recommended Action
S1-S4/ Internal firmware error	Run coasts to a stop	Contact your Beckman Coulter Representative.
S7 Internal firmware error	Run stops using maximum brake	Contact your Beckman Coulter Representative.
S9-10, S14/ Communications error	Run coasts to a stop	Contact your Beckman Coulter Representative.
P5, S15/ Communications error	Run stops using maximum brake	Attempt to clear error. If problem persists, contact your Beckman Coulter Representative.
S108/ Network path access - Cannot reach configured network path	Network path access - Cannot reach configured network path	Check IP settings, network path, network credentials, and remote server connectivity
S109-S110 Network communications error	Network connection lost	Make sure ethernet cable is plugged in. Make sure network is active.

Table C.1 Diagnostics/User Messages Chart (*Continued*)

Message	Definition/Result	Recommended Action
S111/ System data error	Notification only	If problem persists, contact your Beckman Coulter Representative.
S112/ USB port error	Data will not save to or import from USB device	USB device may be full or removed too quickly. Save again using a different USB device.
S113/ Touchscreen not detected	Run stops using maximum brake	If problem persists, contact your Beckman Coulter Representative.
S117/ Printer error	Data will not print	Make sure printer is powered on and necessary drivers are installed. If problem persists, contact your Beckman Coulter Representative.
S123/ Communications error	Notification only	Contact your Beckman Coulter Representative.
S124/ Hard drive space low	Hard drive is 90% full	Backup files soon. Contact your Beckman Coulter Representative.
S127/ Internal software error	Calibration parameters lost	Contact your Beckman Coulter Representative.
S128/ Door lockout active	Unable to open door until lockout time expires	Wait until door lockout timer expires before attempting to open the door.
P3, P200/ AC power loss	Notification only, continue run	Clear error
P4, P201/ AC power loss	Run stops using selected deceleration profile	Clear error
L2/ Door latch error	Run stops using maximum brake	Close door firmly. Clean latch areas with a dry lintless cloth. If error persists, contact your Beckman Coulter Representative.
L3/ Door latch error	Run stops using maximum brake	Clear error and attempt to restart the run. If error persists, contact your Beckman Coulter Representative.
L4/ Door latch error	Run stops using maximum brake	Restart the centrifuge and perform a brief run. If door will still not open after decel, contact your Beckman Coulter Representative.
L5-L7/ Door latch error	Run stops using maximum brake	Do not open the door and power instrument down. Contact your Beckman Coulter Representative.

Table C.1 Diagnostics/User Messages Chart (*Continued*)

Message	Definition/Result	Recommended Action
L8-L10/ Door latch error	Run stops using maximum brake	Clear error, power instrument down and then back up. If error persists, contact your Beckman Coulter Representative.
L11-L12/ Door latch error	Run stops using maximum brake	Turn lights out above instrument, clear error, and attempt to make the run again. If error persists, contact your Beckman Coulter Representative.
I1/ Imbalance error	Run stops using maximum brake	Remove samples and insure rotor is balanced and tied down properly. Restart run. If imbalance continues, contact your Beckman Coulter Representative.
R1, R4/ Rotor not recognized or no rotor	Run stops using maximum brake	Make sure the rotor is installed and compatible with the centrifuge. If error persists, contact your Beckman Coulter Representative.
R3/ Rotor mismatch	Run stops using maximum brake	Insure rotor installed matches rotor entered on user interface. If error persists, contact your Beckman Coulter Representative.
D1-D15/ Drive error	Run coasts to a stop	Contact your Beckman Coulter Representative. Before trying to open the door, listen carefully and make sure that no sound is coming from the chamber (indicating a spinning rotor).
H1-H3/ Speed control error	Run coasts to a stop	Contact your Beckman Coulter Representative.
H4/ Rotor acceleration error	Notification only, continue run	Press STOP, then clear the error Set the new run speed and then press START to begin a new run. If error persists, contact your Beckman Coulter Representative.
H5-H6/ Rotor acceleration error	Notification only, continue run	Contact your Beckman Coulter Representative.
H7/ Communications error	Run coasts to a stop	Contact your Beckman Coulter Representative.
T1-T2/ Temperature control error	Run stops using maximum brake	Contact your Beckman Coulter Representative.
T300/ Set temperature error	Set Temperature automatically adjusted	Clear error

Table C.1 Diagnostics/User Messages Chart (*Continued*)

Message	Definition/Result	Recommended Action
C1, C4/ Temperature control error	Notification only, continue run	If error persists, contact your Beckman Coulter Representative.
C2-C3, C5/ Temperature control error	Run stops using maximum brake	Contact your Beckman Coulter Representative.
F1, F3-F11/ Vacuum error	Run stops using maximum brake	Contact your Beckman Coulter Representative.
F2/ Vacuum error	Notification only, continue run	If error persists, contact your Beckman Coulter Representative.

HEPA Filter Replacement Instructions for the Avanti JXN Series Centrifuges

HEPA Filter Replacement

The external HEPA filter is located on the left side of the centrifuge. To replace the filter assembly, remove the tubing from the plastic barbed fitting protruding from the side of the centrifuge. Install the new filter assembly (B45269) ensuring the arrow on the filter is pointing down.

Figure D.1 HEPA Filter Replacement

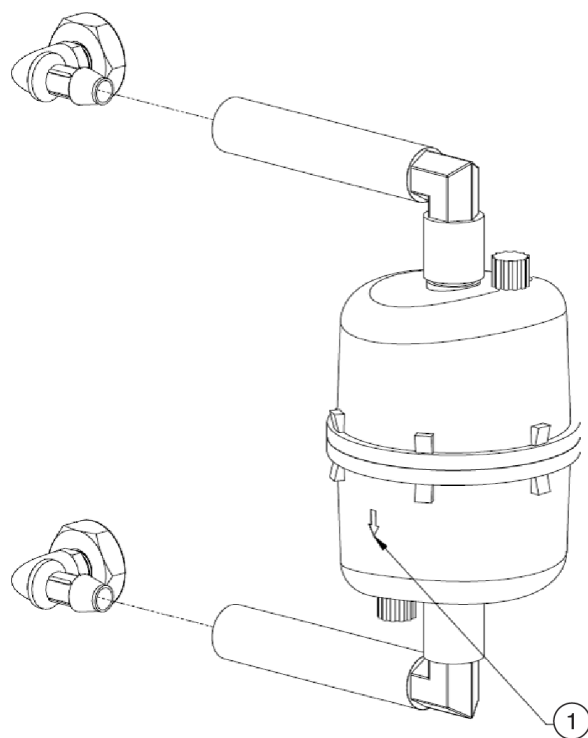

1. Arrow to point down

Abbreviations

A	— Ampere
ACA	— Australian Communication Authority
API	— Application Programming Interface
Btu	— British Thermal Unit
°C	— Degrees Celsius or Degrees Centigrade
cm	— Centimeter
CE	— Conformance European Marking signifying compliance with applicable European directives
CFC	— Chlorofluorocarbon
dB	— Decibel
DHCP	— Dynamic Host Configuration Protocol
DNS	— Domain Name System
DRIC	— Dynamic Rotor Inertia Check
EFUP	— Environmentally Friendly Use Period
ESD	— Electrostatic discharge
°F	— Degrees Fahrenheit
ft	— Foot
FRS	— Friction Reduction System
g	— Grams
HEPA	— High Efficiency Particulate Air
Hr	— Hour
Hz	— Hertz
ID	— Identification
in.	— Inches
IP	— Internet Protocol
IEEE	— Institute of Electrical and Electronics Engineers
ISO	— International Organization for Standardization
IVD	— In-Vitro Diagnostic

KB — Kilobyte
kg — Kilograms
kW — Kilowatt
lb — Pound
LCD — Liquid-Crystal Display
m — Meter
mm — Millimeter
mL — Milliliter
mm Hg — Millimeter of mercury
MSDS — Material Safety Data Sheet
NRTL — Nationally Recognized Testing Laboratory
OEM — Original Equipment Manufacturer
Pa — Pascals
PN — Part Number
RCF — Relative Centrifugal Field
RPM — Rotations per Minute
UNC — Universal Naming Convention
USB — Universal Serial Bus
USPTO — US Patent and Trademark Office
V — Volt
VAC — Voltage Alternating Current
VNC — Virtual Network Computing
W — Watt
WEEE — Waste Electrical and Electronic Equipment

Symbols

- °C
 - defined, [Abbreviations-1](#)
- °F
 - defined, [Abbreviations-1](#)

A

- A
 - defined, [Abbreviations-1](#)
- about
 - manual, [1-xxvii](#)
- about page, [6-58](#)
 - displaying, [2-9](#)
- about your instrument, [2-8](#)
- ACA
 - defined, [Abbreviations-1](#)
- acceleration and deceleration settings
 - example, [6-13](#)
- accessing
 - rotor in case of power failure, [7-6](#)
- add to rotor library page, [6-44](#)
- add/edit user page, [6-55](#)
- adding
 - rotors, [4-8](#)
 - users, [4-5](#)
- additional requirements for three-phase power connections
 - preinstallation requirements, [A-4](#)
- administrator user levels, [4-5](#)
- air filter
 - replacing, [7-4](#)
- alerts
 - safety, [1-v](#)
- API
 - defined, [Abbreviations-1](#)
 - to enable, [4-4](#)
- archive data page, [6-48](#)
- areas on the screen, [2-2](#)
 - accel and decel display/button, [2-6](#)
 - footer bar, [2-4](#)
 - footer bar on other pages, [2-5](#)
 - footer bar on the home page, [2-5](#)

- header bar, [2-2](#)
- help button, [2-4](#)
- home page button, [2-2](#)
- menu button, [2-3](#)
- page display area, [2-6](#)
- start button, [2-4](#)
- status display, [2-3](#)
- stop button, [2-5](#)
- system name, [2-6](#)
- audible sounds
 - specifications, [1-6](#)
- authorize programs page, [6-56](#)
- authorize users page, [6-21](#)
- auto export
 - enable, [4-16](#)
 - run history data, [4-16](#)
- auto print
 - enable, [4-16](#)
 - run history data, [4-16](#)
- available rotors, [1-iii](#), [1-7](#)

B

- basic tab, [6-30](#)
- before run comment page, [4-18](#)
- before run/after run comment page, [6-28](#)
- Btu
 - defined, [Abbreviations-1](#)

C

- calibrating
 - temperature, [B-1](#)
- CE
 - defined, [Abbreviations-1](#)
- centrifugation
 - function, [1-1](#)
- certification, [1-xxviii](#)
- CFC
 - defined, [Abbreviations-1](#)
- CFC-free centrifugation, [1-xxix](#)
- changing
 - defaults for logout timer, [4-6](#)

- defaults for PIN expiration, 4-6
- changing user options, 4-7
- checking for rotor drive pins, A-5
- cleaning
 - the instrument, 7-2
 - tube breakage, 7-3
- cm
 - defined, [Abbreviations-1](#)
- continuous flow page, 3-11
- conventions, 1-xxviii
- copyright
 - software, 1-xxix
- creating
 - programs, 5-2
- custom sounds page, 6-47

D

- dBa
 - defined, [Abbreviations-1](#)
- decontamination, 7-3
- delay start page, 3-7, 6-9
- deleting
 - programs, 5-8
- DHCP
 - defined, [Abbreviations-1](#)
- diagnostic history page, 6-45
- diagnostics/user messages, 7-6, C-1
- display
 - about page, 2-9
- DNS
 - defined, [Abbreviations-1](#)
- door release
 - emergency latch access, 7-7
 - manual, 7-8
- DRIC
 - defined, [Abbreviations-1](#)
- drive, 1-3

E

- editing
 - programs, 5-7
- EFUP
 - defined, [Abbreviations-1](#)
- electrical
 - preinstallation requirements, A-1
- email
 - setup, 4-2
- emergency door release latch access, 7-7

- enable
 - e-signature, 4-18
- enabling
 - API, 4-4
 - auto export, 4-16
 - auto print, 4-16
 - run comments, 4-17
- ESD
 - defined, [Abbreviations-1](#)
- e-signature, 4-18
 - enable, 4-18
 - using, 4-19
- example
 - acceleration and deceleration settings, 6-13
 - export data, 4-14
 - export page, 6-20
 - exporting
 - run history data to a USB drive
 - (manually), 4-14
 - run history data to mapped network
 - (manually), 4-15

F

- features
 - safety, 1-4
- field service, 7-1
- filtering data, 4-10
- friction reduction system, 1-3
- FRS, 1-3
 - defined, [Abbreviations-1](#)
- ft
 - defined, [Abbreviations-1](#)
- function
 - centrifugation, 1-1

G

- g
 - defined, [Abbreviations-1](#)
- graphics, 1-xxxii
- graphing
 - data for a previously completed run, 4-12
 - data for a run in progress, 4-12
- graphing data, 4-12

H

- header bar
 - error message, 2-4

ready status, [2-3](#)
 running status, [2-3](#)
 stopping status, [2-4](#)
 warning message, [2-4](#)
 help messages, [2-6](#)
 global help, [2-6](#)
 item help, [2-6](#)
 HEPA
 defined, [Abbreviations-1](#)
 home page, [2-1](#), [3-2](#), [6-3](#)
 home page (run in progress), [6-5](#)
 housing and door, [1-2](#)
 Hr
 defined, [Abbreviations-1](#)
 Hz
 defined, [Abbreviations-1](#)

I

ID
 defined, [Abbreviations-1](#)
 IEEE
 defined, [Abbreviations-1](#)
 import page, [6-22](#)
 In, [6-49](#)
 in.
 defined, [Abbreviations-1](#)
 instrument
 cleaning, [7-2](#)
 instrument labels
 summary, [1-x](#)
 IP
 defined, [Abbreviations-1](#)
 ISO
 defined, [Abbreviations-1](#)
 IVD
 defined, [Abbreviations-1](#)

J

JCF-Z
 rotor identification, [7-11](#)
 JCF-Z continuous flow/zonal rotor
 using, [A-7](#)

K

KB
 defined, [Abbreviations-2](#)
 kg

defined, [Abbreviations-2](#)
 kW
 defined, [Abbreviations-2](#)

L

labels
 for instrument, [1-x](#)
 lb
 defined, [Abbreviations-2](#)
 LCD
 defined, [Abbreviations-2](#)
 login page, [6-13](#)
 logout timer, [4-6](#)
 changing defaults, [4-6](#)

M

m
 defined, [Abbreviations-2](#)
 maintenance, [7-1](#)
 manage rotors page, [6-43](#)
 manage users page, [6-54](#)
 managing
 reports, [4-9](#)
 rotors, [4-8](#)
 users, [4-5](#)
 your network, [4-1](#)
 manual
 scope, [1-xxviii](#)
 manual door release, [7-8](#)
 manual operation, [3-1](#)
 manually
 operating the run, [3-1](#)
 manually exporting
 run history data to a mapped network, [4-15](#)
 run history data to a USB drive, [4-14](#)
 menu page, [6-29](#)
 mL
 defined, [Abbreviations-2](#)
 mm
 defined, [Abbreviations-2](#)
 mm Hg
 defined, [Abbreviations-2](#)
 MSDS
 defined, [Abbreviations-2](#)

N

name rating plate, [1-2](#)

- network
 - setup, 4-1
 - network tab, 6-32
 - new program name page, 5-4
 - new step in numbered sequence page, 5-6
 - new step page, 5-5
 - new/edit step page, 6-18
 - new/edit/view program page, 6-15
 - notices
 - safety, 1-vii
 - NRTL
 - defined, [Abbreviations-2](#)
- O**
- OEM
 - defined, [Abbreviations-2](#)
 - operating the run
 - manually, 3-1
 - operation
 - zonal and continuous flow, 3-9
 - operator user level, 4-5
 - overtemp system, 1-3
- P**
- Pa
 - defined, [Abbreviations-2](#)
 - page
 - ,manage rotors, 6-43
 - about, 6-58
 - add to rotor library, 6-44
 - add/edit user, 6-55
 - archive data, 6-48
 - authorize programs, 6-56
 - authorize users, 6-21
 - before run comment, 4-18
 - before run/after run comment, 6-28
 - continuous flow, 3-11
 - custom sounds, 6-47
 - delay start, 3-7, 6-9
 - diagnostic history, 6-45
 - export, 6-20
 - home, 2-1, 3-2, 6-3
 - home (run in progress), 6-5
 - home page, 5-2
 - import, 6-22
 - login, 6-13
 - manage users, 6-54
 - menu, 6-29
 - new program name, 5-4
 - new step, 5-5
 - new step in numbered sequence, 5-6
 - new/edit step, 6-18
 - new/edit/view program, 6-15
 - program log, 6-19
 - real-time run data/historical run data, 6-23
 - reset user PIN, 6-39
 - rotor catalog, 6-57
 - run graph options, 4-13, 6-24
 - run history, 4-9, 4-15, 6-25
 - run history filter, 4-10, 6-27
 - select image, 6-40
 - select language, 6-36
 - select printer, 6-51
 - select program, 5-3, 6-14
 - select rotor, 3-4, 5-5
 - select rotor (catalog), 6-17
 - select rotor (library), 6-7
 - set acceleration/deceleration profiles, 3-5, 5-4, 6-12
 - set date and time, 6-41
 - set from date and time, 4-11
 - set sound, 6-46
 - set speed, 3-3, 6-6
 - set speed ω^2t time, 6-10
 - set temperature, 3-8, 6-11
 - set time, 3-6, 6-8
 - setup email, 6-52
 - setup network, 6-49
 - setup VNC, 6-53
 - signature, 4-20
 - system log, 6-42
 - system options, 6-30
 - unnamed program, 5-3
 - user options, 6-37
 - zonal, 3-10
 - zonal authorization, 6-59
 - zonal operation, 6-60
 - zonal operation with cancel button, 3-3
 - performing
 - instrument maintenance, 7-1
 - PIN expiration, 4-6
 - PIN expiration
 - changing defaults, 4-6
 - PN
 - defined, [Abbreviations-2](#)
 - preinstallation
 - electrical requirements, A-1

- requirements, [A-1](#)
- single and three-phase power connection requirements, [A-2](#)
- space and location, [A-4](#)
- three-phase power connections additional requirements, [A-4](#)
- print
 - run history from the run graph page, [4-13](#)
 - run history from the run history page, [4-14](#)
- print data, [4-13](#)
- printer
 - selection, [4-2](#)
- program log page, [6-19](#)
- programs
 - creating, [5-2](#)
 - deleting, [5-8](#)
 - editing, [5-7](#)
 - running, [5-6](#)

R

- RCF
 - defined, [Abbreviations-2](#)
- real-time run data/historical run data page, [6-23](#)
- replacement parts, [7-12](#)
- replacing
 - air filter, [7-4](#)
- reports tab, [6-34](#)
- requirements
 - preinstallation, [A-1](#)
- requiring
 - login, [4-6](#)
- reset user PIN page, [6-39](#)
- rotor catalog page, [6-57](#)
- rotor chamber, [1-2](#)
- rotor identification
 - JCF-Z, [7-11](#)
- rotors
 - adding, [4-8](#)
- RPM
 - defined, [Abbreviations-2](#)
- run comments
 - enable, [4-17](#)
 - use, [4-17](#)
- run graph options page, [4-13](#), [6-24](#)
- run history data
 - auto export, [4-16](#)
 - auto print, [4-16](#)
- run history filter page, [4-10](#), [6-27](#)

- run history page, [4-9](#), [4-15](#), [6-25](#)
- running
 - programs, [5-6](#)

S

- safety
 - alerts, [1-v](#)
 - features, [1-4](#)
 - notices, [1-vii](#)
- scope of manual, [1-xxviii](#)
- Select, [4-19](#)
- select image page, [6-40](#)
- select language page, [6-36](#)
- select printer page, [6-51](#)
- select program page, [5-3](#), [6-14](#)
- select rotor page, [3-4](#), [5-5](#)
- select rotor page (catalog), [6-17](#)
- select rotor page (library), [6-7](#)
- selecting
 - a printer, [4-2](#)
- set acceleration/deceleration profiles page, [3-5](#), [5-4](#), [6-12](#)
- set date and time page, [6-41](#)
- set from date and time page, [4-11](#)
- set sound page, [6-46](#)
- set speed page, [3-3](#), [6-6](#)
- set speed ω^2t time page, [6-10](#)
- set temperature page, [3-8](#), [6-11](#)
- set time page, [3-6](#), [6-8](#)
- setting the
 - acceleration and deceleration profiles, [3-5](#)
 - speed and rotor, [3-4](#)
 - temperature, [3-8](#)
 - time, [3-6](#)
- setting up
 - email, [4-2](#)
 - the network, [4-1](#)
 - VNC, [4-3](#)
- setup email page, [6-52](#)
- setup network page, [6-49](#)
- setup VNC page, [6-53](#)
- signature page, [4-20](#)
- single and three-phase power connection preinstallation requirements, [A-2](#)
- software
 - copyright, [1-xxix](#)
- space and location
 - preinstallation requirements, [A-4](#)
- specifications

- audible sounds, 1-6
- J-26S XPI, 1-4
- J-30I, 1-4
- step 1
 - start on the home page, 3-2
- step 2
 - set the speed and rotor, 3-3
- step 3
 - set the acceleration and deceleration profiles, 3-4
- step 4
 - set the time, 3-6
- step 5
 - set the temperature, 3-8
- step 6
 - start the run, 3-8
- sterilization and disinfection, 7-4
- storage and transportation, 7-12
 - replacement parts, 7-12
 - supply list, 7-12
- super user level, 4-5
- supply list, 7-12
- symbols, 1-xxx
- system
 - overtemp, 1-3
- system log page, 6-42
- system options page, 6-30
- system tab, 6-31

T

- tab
 - basic, 6-30
 - network, 6-32
 - system, 6-31
 - users, 6-33
- temperature
 - calibration, B-1
- temperature control, 1-3
- temperature sensing, 1-3
- touch screen, 1-2
- tube breakage
 - cleaning, 7-3

U

- UNC
 - defined, [Abbreviations-2](#)
- unnamed program page, 5-3
- USB

- defined, [Abbreviations-2](#)

- user
 - changing options, 4-7
 - options, 4-7
- user access, 4-9
- user levels, 4-5
 - administrator, 4-5
 - operator, 4-5
 - super user, 4-5
- user options page, 6-37
- users tab, 6-33
- using
 - e-signature, 4-19
 - JCF-Z continuous flow/zonal rotor, A-7
 - run comments, 4-17
- using J2 series rotors in the Avanti J-26S XPI, A-5
- USPTO
 - defined, [Abbreviations-2](#)

V

- V
 - defined, [Abbreviations-2](#)
- VAC
 - defined, [Abbreviations-2](#)
- VNC
 - defined, [Abbreviations-2](#)
 - setup, 4-3

W

- W
 - defined, [Abbreviations-2](#)
- WEEE
 - defined, [Abbreviations-2](#)

Z

- zonal and continuous flow operation, 3-9
- zonal authorization page, 6-59
- zonal operation page, 6-60
- zonal or continuous flow run
 - seven phases, 3-10
- zonal or continuous flow run seven phases
 - finishing, 3-10, 3-12
 - loading, 3-10, 3-11
 - preparing, 3-10
 - running, 3-10, 3-12
 - starting, 3-10, 3-11
 - stopping, 3-10, 3-12

unloading, [3-10](#), [3-12](#)
zonal page, [3-10](#)

Beckman Coulter, Inc.

Avanti JXN Series Centrifuge Warranty

Subject to the exceptions and upon the conditions specified below Beckman Coulter, Inc. agrees to correct either by repair, or, at its election, by replacement, any defects of material or workmanship which develop within one (1) year (3 years for the drive motor) after delivery of the Avanti JXN Series Centrifuge (the product), to the original buyer by Beckman Coulter or by an authorized representative, provided that investigation and factory inspection by Beckman Coulter discloses that such defect developed under normal and proper use.

Some components and accessories by their nature are not intended to and will not function for as long as one (1) year. If any such component or accessory fails to give reasonable service for a reasonable period of time, Beckman Coulter will repair or, at its election, replace such component or accessory. What constitutes either reasonable service and a reasonable period of time shall be determined solely by Beckman Coulter.

Replacement

Any product claimed to be defective must, if requested by Beckman Coulter, be returned to the factory, transportation charges prepaid, and will be returned to Buyer with the transportation charges collect unless the product is found to be defective, in which case Beckman Coulter will pay all transportation charges.

Beckman Coulter makes no warranty concerning products or accessories not manufactured by it. In the event of failure of any such product or accessory, Beckman Coulter will give reasonable assistance to the Buyer in obtaining from the respective manufacturer whatever adjustment is reasonable in light of the manufacturer's own warranty.

Conditions

Beckman Coulter shall be released from all obligations under all warranties, either expressed or implied, if the product covered hereby is repaired or modified by persons other than its own authorized service personnel, unless such repair by others is made with the written consent of Beckman Coulter, or unless such repair in the sole opinion of Beckman Coulter is minor, or unless such modifications is merely the installation of a new Beckman Coulter plug-in component for such product.

Disclaimer

IT IS EXPRESSLY AGREED THAT THE ABOVE WARRANTY SHALL BE IN LIEU OF ALL WARRANTIES OF FITNESS AND OF THE WARRANTY OF MERCHANTABILITY AND THAT BECKMAN COULTER, INC. SHALL HAVE NO LIABILITY FOR SPECIAL OR CONSEQUENTIAL DAMAGES OF ANY KIND WHATSOEVER ARISING OUT OF THE MANUFACTURE, USE, SALE, HANDLING, REPAIR, MAINTENANCE, OR REPLACEMENT OF THE PRODUCT.

Related Documents

Rotors and Tubes for Beckman Coulter J2, J6, and Avanti J Series Centrifuges

PN JR-IM-10

- Rotors
- Tubes, Bottles, and Accessories
- Using Tubes and Accessories
- Using Fixed-Angle Rotors
- Using Swinging-Bucket Rotors
- Using Vertical-Tube and Rack Type Rotors
- Care and Maintenance
- Chemical Resistances
- Temperature Compensation Tables
- Gradient Materials

Available in electronic pdf or CD-ROM by request.

Chemical Resistances for Beckman Coulter Centrifugation Products

PN IN-175

Available at www.beckman.com

High-Performance and High-Capacity Centrifuges Catalog

PN BR-8102

Available at www.beckman.com

Preinstallation Requirements for Avanti JXN Series Centrifuges

PN B39493

Available at www.beckman.com

www.beckman.com

