

Instructions For Use

TLA-100.3 Fixed-Angle Rotor

For Use in Beckman Coulter
Optima MAX-XP, Optima MAX-TL,
MAX, MAX-E, TL, TLX, and TL-100
Tabletop Ultracentrifuges



PN TL-TB-011AM
February 2014



Beckman Coulter, Inc.
250 S. Kraemer Blvd.
Brea, CA 92821 U.S.A.



TLA-100.3 Fixed-Angle Rotor
PN TL-TB-011AM (February 2014)

Copyright 1986–2014 Beckman Coulter, Inc.
All rights reserved.

No part of this document may be reproduced or transmitted in any form or by any means, electronic, mechanical, photocopying, recording, or otherwise, without prior written permission from Beckman Coulter, Inc.

Beckman Coulter, Microfuge, Optima, Quick-Seal and the stylized logo are trademarks of Beckman Coulter, Inc. and are registered in the USPTO.

All other trademarks, service marks, products, or services are trademarks or registered trademarks of their respective holders.

Find us on the World Wide Web at:
www.beckmancoulter.com

Printed in U.S.A.

Safety Notice

Read all product manuals and consult with Beckman Coulter-trained personnel before attempting to use this equipment. Do not attempt to perform any procedure before carefully reading all instructions. Always follow product labeling and manufacturer's recommendations. If in doubt as to how to proceed in any situation, contact your Beckman Coulter Representative.

Alerts for Warning, Caution, and Note



WARNING indicates a potentially hazardous situation which, if not avoided, could result in death or serious injury.



CAUTION indicates a potentially hazardous situation, which, if not avoided, may result in minor or moderate injury. It may also be used to alert against unsafe practices.

NOTE NOTE is used to call attention to notable information that should be followed during installation, use, or servicing of this equipment.

Safety Information for the TLA-100.3 Rotor

Handle body fluids with care because they can transmit disease. No known test offers complete assurance that such fluids are free of micro-organisms. Some of the most virulent—Hepatitis (B and C) viruses, HIV (I–V), atypical mycobacteria, and certain systemic fungi—further emphasize the need for aerosol protection. Handle other infectious samples according to good laboratory procedures and methods to prevent spread of disease. Because spills may generate aerosols, observe proper safety precautions for aerosol containment.

Do not run toxic, pathogenic, or radioactive materials in this rotor without taking appropriate safety precautions. Biosafe containment should be used when Risk Group II materials (as identified in the World Health Organization *Laboratory Biosafety Manual*) are handled; materials of a higher group require more than one level of protection.

The rotor and accessories are not designed for use with materials capable of developing flammable or explosive vapors. Do not centrifuge such materials in nor handle or store them near the ultracentrifuge.

Although rotor components and accessories made by other manufacturers may fit in the TLA-100.3 rotor, their safety in this rotor cannot be ascertained by Beckman Coulter. Use of other manufacturers' components or accessories in the TLA-100.3 rotor may void the rotor warranty and should be prohibited by your laboratory safety officer. Only the components and accessories listed in this publication should be used in this rotor.

Safety Notice

Safety Information for the TLA-100.3 Rotor

Make sure that filled containers are loaded symmetrically into the rotor and that opposing tubes are filled to the same level with liquid of the same density. Make sure that cavities in use have the proper spacers and/or floating spacers inserted before installing the rotor lid.

If disassembly reveals evidence of leakage, you should assume that some fluid escaped the rotor. Apply appropriate decontamination procedures to the centrifuge and accessories.

Never exceed the maximum rated speed of the rotor and labware in use. Refer to the section on [Run Speeds](#).

Do not use sharp tools on the rotor that could cause scratches in the rotor surface. Corrosion begins in scratches and may open fissures in the rotor with continued use.

Contents



Safety Notice, iii

Alerts for Warning, Caution, and Note, iii

Safety Information for the TLA-100.3 Rotor, iii

TLA-100.3 Fixed-Angle Rotor, 1

Specifications, 1

Description, 2

Preparation and Use, 3

Prerun Safety Checks, 3

Rotor Preparation, 3

Operation, 4

Removal and Sample Recovery, 5

Tubes and Accessories, 6

Temperature Limits, 6

Quick-Seal Tubes, 7

Thickwall Tubes, 7

Microfuge Tubes, 7

Run Times, 7

Run Speeds, 8

Selecting CsCl Gradients, 11

Adjusting Fill Volume, 11

Typical Examples for Determining CsCl Run Parameters, 16

Care and Maintenance, 17

Maintenance, 17

Cleaning, 18

Decontamination, 19

Sterilization and Disinfection, 20

Storage, 20

Returning a Rotor, 20

Supply List, 21

Replacement Rotor Parts, 21

Other, 21

Illustrations

- 1 Arranging Tubes in the Rotor., 4
- 2 Precipitation Curves (3.5-mL Quick-Seal Tubes) for the TLA-100.3 Rotor, 12
- 3 CsCl Gradients at Equilibrium (3.5-mL Quick-Seal Tubes), 13
- 4 Precipitation Curves (Open Top Tubes) for the TLA-100.3 Rotor, 14
- 5 CsCl Gradients at Equilibrium (Open Top Tubes), 15

Tables

- 1 Available Tubes for the TLA-100.3 Rotor, 6
- 2 Relative Centrifugal Fields for the TLA-100.3 Rotor, 10

TLA-100.3 Fixed-Angle Rotor

Specifications

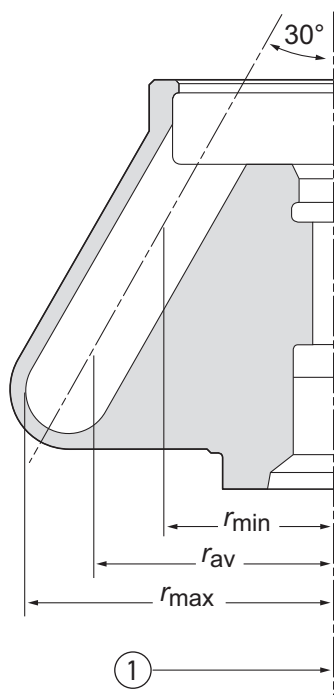

1. Axis of Rotation

Maximum speed	100,000 RPM
Density rating at maximum speed	1.7 g/mL
Relative Centrifugal Field ^a at maximum speed ^b	
at r_{max} (48.3 mm)	$541,000 \times g$
at r_{av} (37.9 mm)	$424,000 \times g$
at r_{min} (27.5 mm)	$308,000 \times g$
k factor at maximum speed	14
Conditions requiring speed reductions	see Run Speeds
Number of tube cavities	6
Available tubes	see Table 1
Nominal tube dimensions (largest tube)	13 × 51 mm
Nominal tube capacity	3.5 mL
Nominal rotor capacity	21 mL
Approximate acceleration time to maximum speed (fully loaded)	4 min
Approximate deceleration time from maximum speed (fully loaded)	2 min
Weight of fully loaded rotor	1.0 kg (2.2 lb)
Rotor material	titanium

a. Relative Centrifugal Field (RCF) is the ratio of the centrifugal acceleration at a specified radius and speed ($r\omega^2$) to the standard acceleration of gravity (g) according to the following formula: $RCF = r\omega^2/g$ — where r is the radius in millimeters, ω is the angular velocity in radians per second ($2\pi \text{ RPM} / 60$), and g is the standard acceleration of gravity (9807 mm/s^2). After substitution: $RCF = 1.12r (\text{RPM}/1000)^2$

b. Using 3.5-mL Quick-Seal tubes.

Description

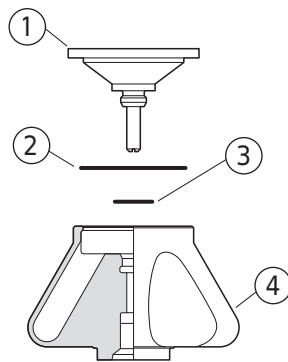

1. Lid Assembly (349478)
2. Lid O-ring (outer) (854521)
3. Lid O-ring (inner) (824412)
4. Rotor Body

Beckman Coulter TLA-100.3 rotors are manufactured in a facility that maintains certifications to both ISO 9001:2008 and ISO 13485:2003. They are for use with the specified Beckman Coulter ultracentrifuges. The rotors were developed, manufactured, and tested for safety and reliability as part of a Beckman Coulter ultracentrifuge/rotor system. Their safety or reliability cannot be assured if used in an ultracentrifuge not of Beckman Coulter's manufacture or in a Beckman Coulter ultracentrifuge that has been modified without Beckman Coulter's approval.

The TLA-100.3 fixed-angle rotor has a tube angle of 30 degrees from the axis of rotation. The rotor can centrifuge up to six tubes.

The rotor is made of titanium and is finished with black polyurethane paint. The lid is made of aluminum and anodized to resist corrosion. A plunger in the lid locks the rotor to the drive hub before beginning the run, and two lubricated O-rings made of Buna-N rubber maintain atmospheric pressure inside the rotor during centrifugation. The tube cavities are numbered to aid in sample identification.

The rotor is specially designed with a fluid-containment annulus located below the O-ring sealing surface. The annulus retains fluid that may escape from leaking or overfilled tubes, thereby preventing the liquid from escaping into the instrument chamber.

The ultracentrifuge identifies rotor speed during the run by means of a magnetic speed sensor in the instrument chamber and magnets on the bottom of the rotor. This overspeed protection system ensures that the rotor does not exceed its maximum permitted speed.

Refer to the Warranty at the back of this manual for warranty information.

Preparation and Use

*Specific information about the TLA-100.3 rotor is given here. Information common to this and other rotors is contained in *Rotors and Tubes for Tabletop Preparative Ultracentrifuges* (publication TLR-IM), which should be used together with this manual for complete rotor and accessory operation.*

NOTE Although rotor components and accessories made by other manufacturers may fit in the TLA-100.3 rotor, their safety in this rotor cannot be ascertained by Beckman Coulter. Use of other manufacturers' components or accessories in the TLA-100.3 rotor may void the rotor warranty and should be prohibited by your laboratory safety officer. Only the components and accessories listed in this publication should be used in this rotor.

Prerun Safety Checks

Read the [Safety Notice](#) section at the front of this manual before using the rotor.

- 1 Inspect the O-rings and plunger mechanism for damage—the high forces generated in this rotor can cause damaged components to fail.
- 2 Use only tubes and accessories listed in [Table 1](#).
- 3 Check the chemical compatibilities of all materials used (refer to *Chemical Resistances*, publication IN-175).

Rotor Preparation

For runs at other than room temperature, refrigerate or warm the rotor beforehand for fast equilibration.

- 1 Lightly but evenly lubricate metal threads with Spinkote lubricant (306812).
- 2 Apply a thin film of silicone vacuum grease (335148) to the two O-rings in the rotor lid.
- 3 If adapters are required, place them into the tube cavities before inserting the tubes.
- 4 Load the filled and capped tubes symmetrically into the rotor (see page 6 for tube information). If fewer than six tubes are being run, they must be arranged symmetrically in the rotor (see [Figure 1](#)).

Opposing tubes must be filled to the same level with liquid of the same density.

Figure 1 Arranging Tubes in the Rotor.

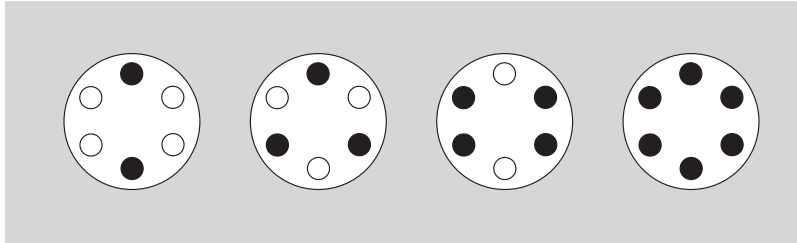

NOTE Two, three, four, or six tubes can be centrifuged per run if they are arranged in the rotor as shown.

- 5 Use the required spacers, if necessary (see [Table 1](#)), to complete the loading operation.
- 6 After the rotor is loaded, insert it into the portable polypropylene rotor vise (346133).
 - a. Place the lid on the rotor and tighten it firmly to the right (clockwise) by hand. No tool is required.

Operation

- 1 Use an absorbent towel to wipe off condensation from the rotor, then carefully place the rotor on the drive hub.
- 2 Lock the rotor in place by gently pressing the plunger down until you feel it click. When you remove your finger, the plunger will remain flush with the rotor body if it is properly engaged.

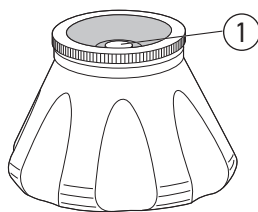

1. Plunger Engaged

If the plunger pops up, repeat the procedure.

The Optima MAX-TL, MAX-XP, MAX, and MAX-E ultracentrifuges automatically secure the rotor to the drive shaft without the need for engaging the plunger.

CAUTION

In all ultracentrifuge models except the Optima MAX-TL, MAX-XP, MAX, and MAX-E, it is very important to lock the rotor in place before beginning the run to ensure that the rotor remains seated during centrifugation. Failure to lock the rotor in place before beginning the run may result in damage to both rotor and instrument.

3 Refer to the instrument instruction manual for ultracentrifuge operation.

4 For additional operating information, see the following:

- [Run Times](#), page 7, for using k factors to adjust run durations.
- [Run Speeds](#), page 8, for information about speed limitations.
- [Selecting CsCl Gradients](#), page 11, for methods to avoid CsCl precipitation during centrifugation.

Removal and Sample Recovery

CAUTION

If disassembly reveals evidence of leakage, you should assume that some fluid escaped the rotor. Apply appropriate decontamination procedures to the centrifuge and accessories.

1 To release the plunger at the end of the run, gently press it down until you feel it click. When you remove your finger the plunger will pop up to its released position.

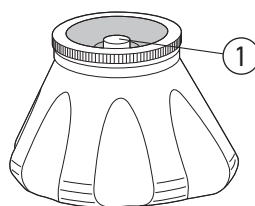

1. Plunger Released

2 Remove the rotor from the ultracentrifuge and place it in the rotor vise.

3 Remove the lid by unscrewing it to the left (counterclockwise).

4 Use a tube removal tool to remove the spacers and tubes.

Tubes and Accessories

The TLA-100.3 rotor uses tubes and accessories listed in [Table 1](#). Be sure to use only those items listed, and to observe the maximum speed limits shown. Refer to *Chemical Resistances* (IN-175) for information on the chemical compatibilities of tube and accessory materials.

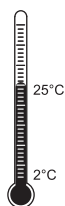

Temperature Limits

- Plastic tubes have been centrifuge tested for use at temperatures between 2 and 25°C. For centrifugation at other temperatures, pretest tubes under anticipated run conditions.
- If plastic containers are frozen before use, make sure that they are thawed to at least 2°C prior to centrifugation.

Table 1 Available Tubes for the TLA-100.3 Rotor^a

Tube			Required Accessory		Max. Speed/ RCF/k Factor
Dimensions and Volume	Description	Part Number	Description	Part Number	
13 × 32 mm 3.5 mL	Quick-Seal polypropylene	349621 (pkg/50)	polyphenylene oxide (PPO) spacer	355937 (pkg/6)	100,000 RPM 541,000 × g 14
13 × 51 mm 3.0 mL	thickwall polycarbonate	349622 (pkg/25)	none	—	100,000 RPM 541,000 × g 16
13 × 51 mm 3.0 mL	thickwall polypropylene	349623 (pkg/25)	none	—	70,000 RPM ^{bc} 265,000 × g 34
13 × 25 mm 2.0 mL	Quick-Seal polypropylene	345829 (pkg/50)	polyphenylene oxide (PPO) spacer	360270 (pkg/6)	100,000 RPM 541,000 × g 11
11 × 38 mm 1.5 mL	Microfuge, polypropylene (capped)	357448 (pkg/50)	acetal (POM) adapter	355919 (pkg/8)	70,000 RPM ^{bd} 245,000 × g 24

- Use only the items listed here and observe maximum fill volumes and speeds shown.
- Stress cracking and collapse can occur at high speeds. Discard these tubes after a single use.
- These maximum speeds were determined using water samples. Use of other solvents may require further speed reduction to prevent tube failure.
- At 40°C, speed must be reduced to 59,000 RPM.

Quick-Seal Tubes



Quick-Seal tubes must be sealed prior to centrifugation. These tubes are heat sealed and do not need caps; however, spacers are required on top of the tubes when they are loaded into the rotor.

- 1 Fill Quick-Seal tubes leaving a small bubble of air at the base of the neck.
Do not leave a large air space—too much air can cause excessive tube deformation.
Refer to *Rotors and Tubes* for detailed information on the use and care of Quick-Seal tubes.



Thickwall Tubes

Thickwall polypropylene and polycarbonate tubes can be run partially filled (at least half filled) without caps, but all opposing tubes for a run must be filled to the same level with liquid of the same density. Do not overfill capless tubes; be sure to note the reduction in run speed shown in [Table 1](#).

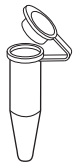

Microfuge Tubes

The 1.5-mL microfuge tubes, with attached caps, are made of clear polypropylene. The tubes are placed in adapters for use in this rotor. All opposing tubes for a run must be filled with liquid of the same density. Be sure to note the run speed reduction shown in [Table 1](#).

Run Times

The k factor of the rotor is a measure of the rotor's pelleting efficiency. Beckman Coulter has calculated the k factors for all of its preparative rotors at maximum rated speed and using full tubes. The k factor is calculated from the formula:

EQ 1

$$k = \frac{\ln(r_{\max}/r_{\min})}{\omega^2} \times \frac{10^{13}}{3600}$$

where ω is the angular velocity of the rotor in radians per second ($\omega = 0.105 \times \text{RPM}$), r_{\max} is the maximum radius, and r_{\min} is the minimum radius.

After substitution:

EQ 2

$$k = \frac{(2.533 \times 10^{11}) \ln(r_{\max}/r_{\min})}{(\text{RPM})^2}$$

Use the k factor in the following equation to estimate the run time t (in hours) required to pellet particles of known sedimentation coefficient s (in Svedberg units, S).

EQ 3

$$t = \frac{k}{s}$$

Run times can be estimated for centrifugation at less than maximum speed by adjusting the k factor as follows:

EQ 4

$$k_{\text{adj}} = k \left(\frac{100,000}{\text{actual run speed}} \right)^2$$

Run times can also be estimated from data established in prior experiments if the k factor of the previous rotor is known. For any two rotors, a and b:

EQ 5

$$\frac{t_a}{t_b} = \frac{k_a}{k_b}$$

For more information on k factors see *Using k Factors to Compare Rotor Efficiency* (publication DS-9721A).

Run Speeds

The centrifugal force at a given radius in a rotor is a function of speed. Comparisons of forces between different rotors are made by comparing the rotors' relative centrifugal fields (RCF). When rotational speed is adjusted so that identical samples are subjected to the same RCF in two different rotors, the samples are subjected to the same force. The RCF at a number of rotor speeds is provided in [Table 2](#).

Speeds must be reduced under the following circumstances:

1. If nonprecipitating solutions more dense than 1.7 g/mL are centrifuged, the maximum allowable run speed must be reduced according to the following equation:

EQ 6

$$\text{reduced maximum speed} = (100,000 \text{ RPM}) \sqrt{\frac{1.7 \text{ g/mL}}{\rho}}$$

where ρ is the density of the tube contents. This speed reduction will protect the rotor from excessive stresses due to the added tube load. *Note, however, that the use of this formula may still produce maximum speed values that are higher than the limitations imposed by the use of certain tubes or adapters.* In such cases, use the lower of the two values.

2. *Further speed limits must be imposed* when CsCl or other self-forming-gradient salts are centrifuged, as equation (6) does not predict concentration limits/speeds that are required to avoid precipitation of salt crystals. Precipitation during centrifugation would alter the density distribution of CsCl and this would change the position of the sample bands. [Figure 2](#) and [Figure 4](#), together with the description and examples below, show how to reduce run speeds when using CsCl gradients.

Table 2 Relative Centrifugal Fields for the TLA-100.3 Rotor^a

Rotor Speed (RPM)	Relative Centrifugal Field ($\times g$)			k Factor*
	At r_{max} (48.3 mm)	At r_{av} (37.9 mm)	At r_{min} (27.5 mm)	
100,000	541,000	424,000	308,000	14
95,000	488,000	383,000	278,000	16
90,000	438,000	344,000	249,000	18
85,000	391,000	307,000	223,000	20
80,000	346,000	372,000	197,000	22
75,000	304,000	239,000	173,000	25
70,000	265,000	208,000	151,000	29
65,000	229,000	179,000	130,000	34
60,000	195,000	153,000	111,000	39
55,000	164,000	128,000	93,000	47
50,000	135,000	106,000	77,100	57
45,000	110,000	86,000	63,000	70
40,000	87,000	68,000	49,300	89
35,000	66,300	52,000	38,000	116
30,000	49,000	38,200	28,000	158
25,000	33,800	26,500	19,300	227
20,000	21,600	17,000	12,300	335

a. Entries in this table are calculated from the formula $RCF = 1.12r (RPM/1000)^2$ and then rounded to three significant digits.

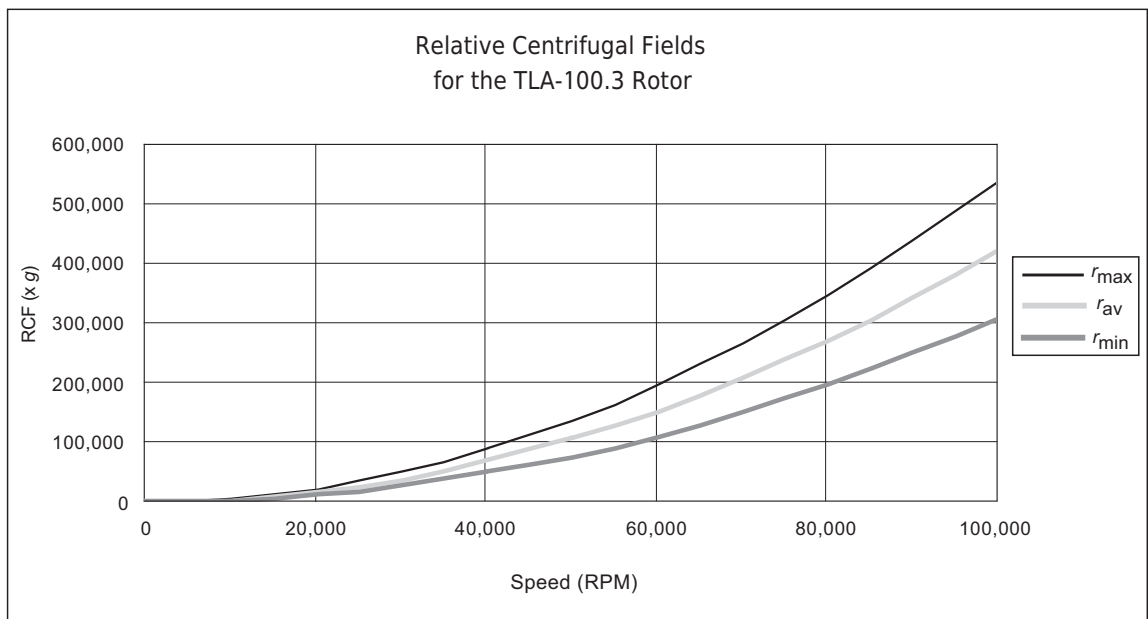

Selecting CsCl Gradients

Precipitation during centrifugation would alter density distribution, and this would change the position of the sample bands. Curves in [Figure 2](#) and [Figure 3](#) are provided up to the maximum rated speed of the rotor.

NOTE The curves in [Figure 2](#) and [Figure 4](#) are for solutions of CsCl salt dissolved in distilled water only. If other salts are present in significant concentrations, the overall CsCl concentration may need to be reduced.

Rotor speed is used to control the slope of a CsCl density gradient, and must be limited so that CsCl precipitation is avoided. Speed and density combinations that intersect on or below the curves in [Figure 3](#) or [Figure 4](#) ensure that CsCl will not precipitate during centrifugation in the TLA-100.3 rotor. Curves are provided at two temperatures: 20°C (black curves) and 4°C (gray curves).

The reference curves in [Figure 3](#) and [Figure 5](#) show gradient distribution at equilibrium. Each curve in [Figure 3](#) or [Figure 5](#) is within the density limits allowed for the TLA-100.3 rotor: each curve was generated for a single run speed using the maximum allowable homogeneous CsCl densities (one for each fill level) that avoid precipitation at that speed. (The gradients in [Figure 3](#) or [Figure 5](#) can be generated from step or linear gradients, or from homogeneous solutions. But the total amount of CsCl in solution must be equivalent to a homogeneous solution corresponding to the concentrations specified in [Figure 2](#) or [Figure 4](#).) [Figure 3](#) or [Figure 5](#) can also be used to approximate the banding positions of sample particles.

Adjusting Fill Volume

[Figure 2](#) and [Figure 3](#) show that several fill volumes are possible in a tube. If a tube is partially filled with gradient solution, float mineral oil (or some other low-density, immiscible liquid) on top of the tube contents to fill the tube to its maximum volume. Note that for a given CsCl density, as the fill level decreases the maximum allowable speed increases. Partial filling may be desirable when there is little sample or when you wish to shorten the run time.

For example, a *three-quarter-filled* tube of 1.55-g/mL homogeneous CsCl solution at 20°C may be centrifuged at 90,000 RPM (see [Figure 4](#)). The segment of the 90,000-RPM curve ([Figure 5](#)) from the three-quarter-filled line to 1.86-g/mL at the tube bottom represents this gradient. The same solution in a full tube may be centrifuged no faster than 83,000 RPM.

Figure 2 Precipitation Curves (3.5-mL Quick-Seal Tubes) for the TLA-100.3 Rotor*

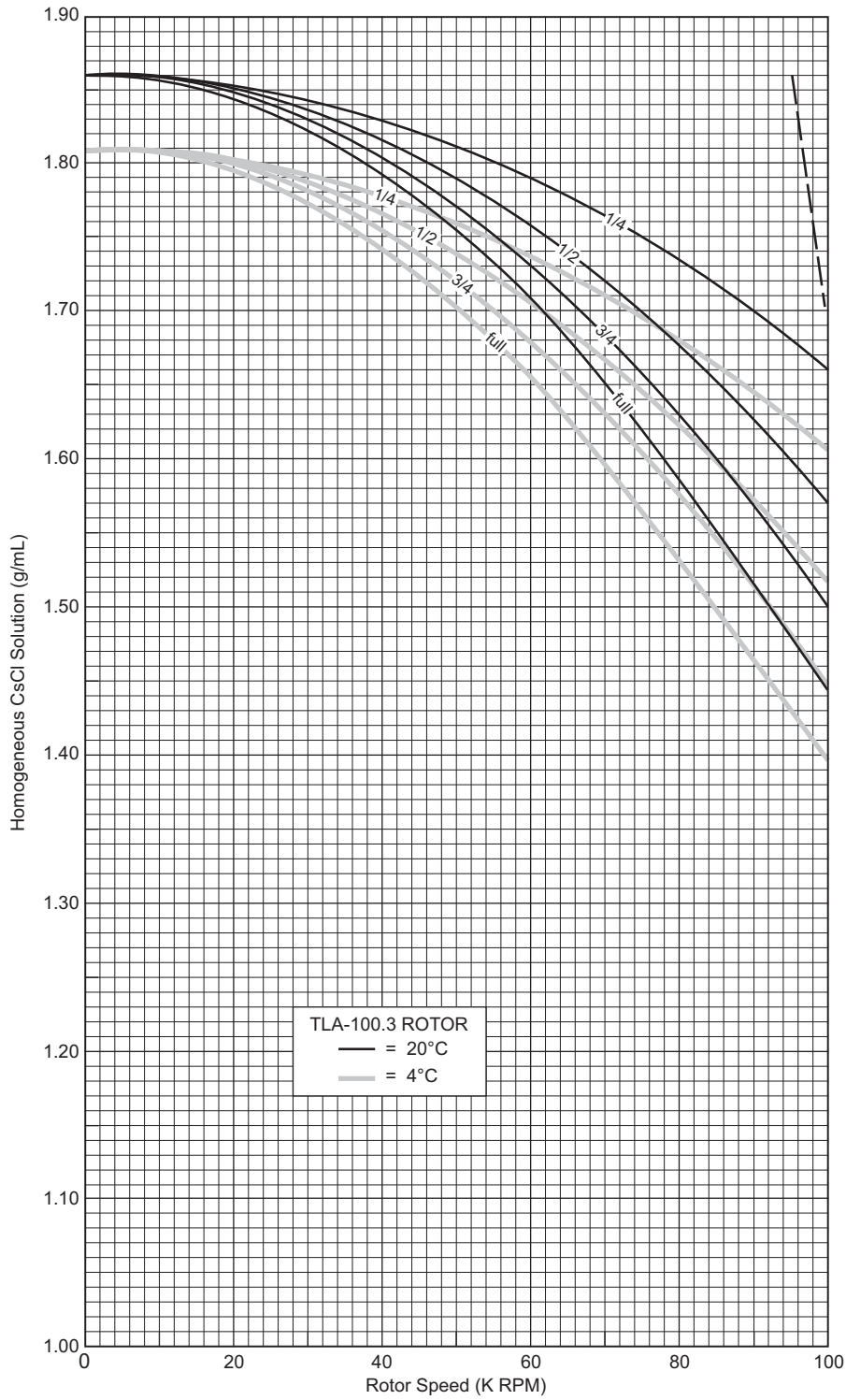

* Using combinations of rotor speeds and homogeneous CsCl solution densities that intersect on or below these curves ensures that CsCl will not precipitate during centrifugation. The dashed line is a representation of EQ 6 and is shown here to illustrate the inability of that equation to guard against CsCl precipitation.

Figure 3 CsCl Gradients at Equilibrium (3.5-mL Quick-Seal Tubes)*

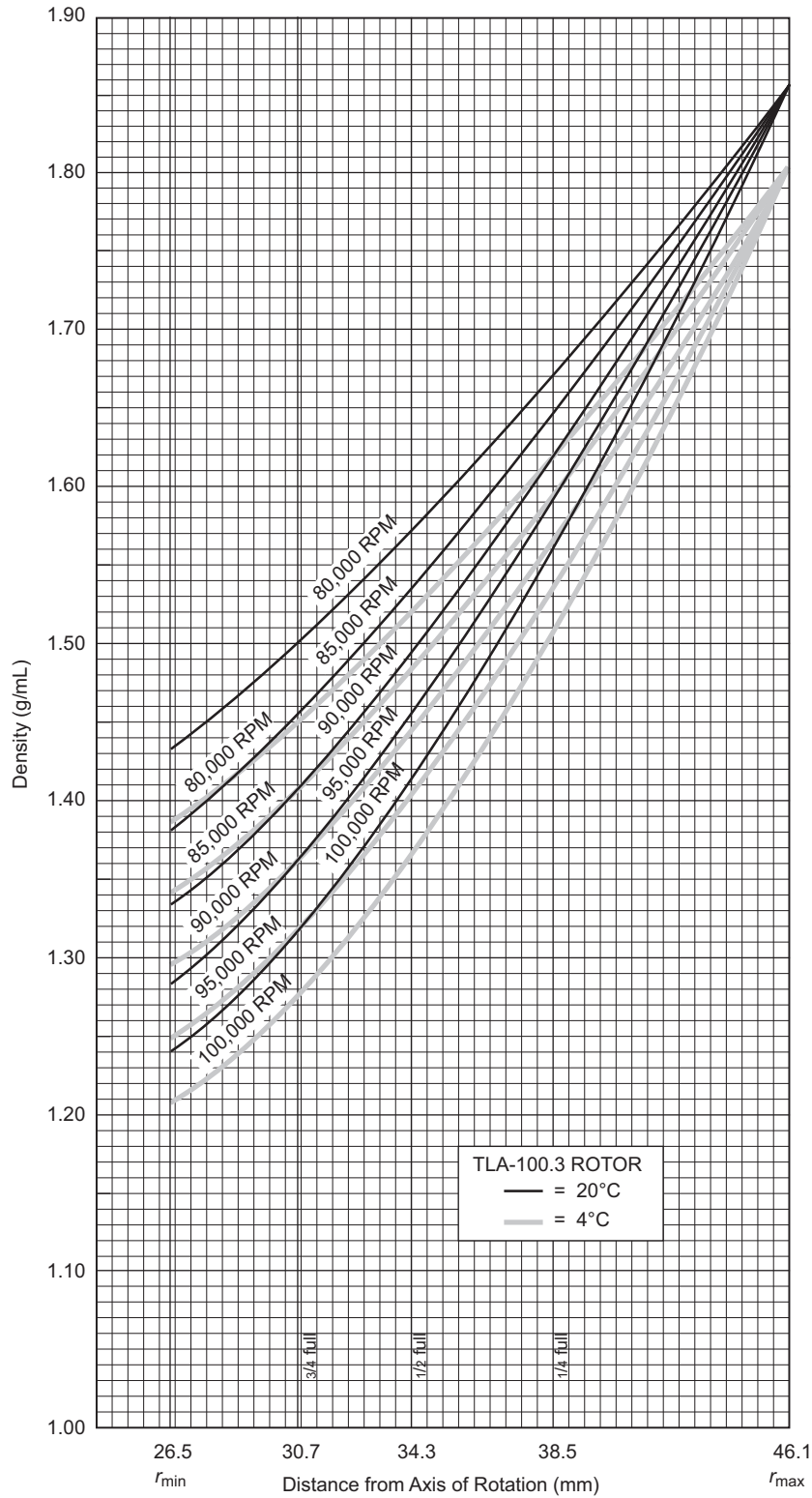

* Centrifugation of homogeneous CsCl solutions at the maximum allowable speeds (from Figure 2) results in gradients presented here.

Figure 4 Precipitation Curves (Open Top Tubes) for the TLA-100.3 Rotor*

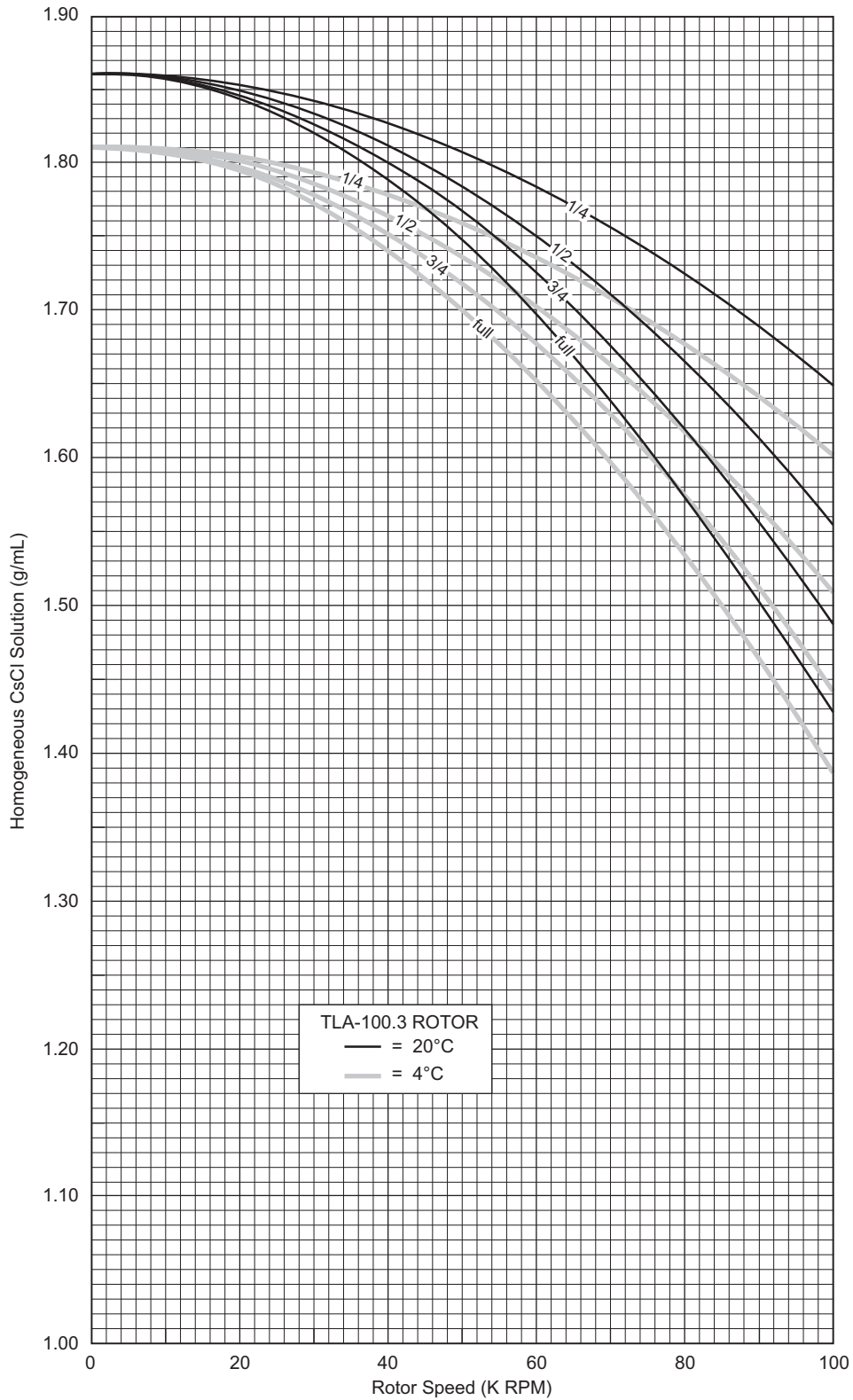

* Using combinations of rotor speeds and homogeneous CsCl solution densities that intersect on or below these curves ensures that CsCl will not precipitate during centrifugation.

Figure 5 CsCl Gradients at Equilibrium (Open Top Tubes)*

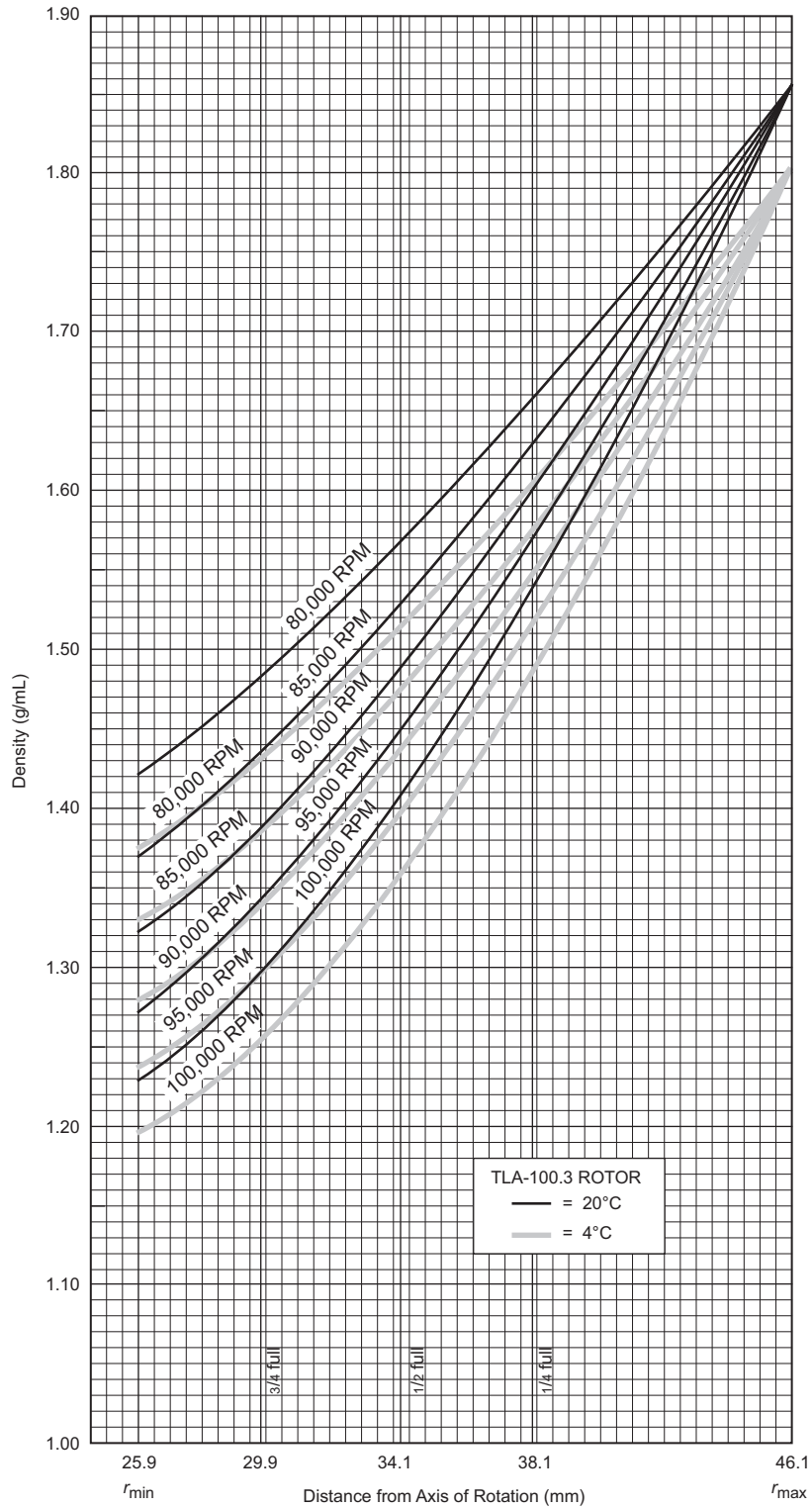

* Centrifugation of homogeneous CsCl solutions at the maximum allowable speeds (from Figure 4) results in gradients presented here.

Typical Examples for Determining CsCl Run Parameters

Example A:

A separation that is done frequently is the banding of plasmic DNA in cesium chloride with ethidium bromide. The starting density of the CsCl solution is 1.55 g/mL. In this separation the covalently closed, circular plasmid bands at a density of 1.57 g/mL, while the nicked and linear species band at 1.53 g/mL. At 20°C, where will particles band?

- 1 In [Figure 2](#), find the curve that corresponds to the required run temperature (20°C) and fill volume (full).
 The maximum allowable rotor speed is determined from the point where this curve intersects the homogeneous CsCl density (80,000 RPM).
- 2 In [Figure 3](#), sketch in a horizontal line corresponding to each particle's buoyant density.
- 3 Mark the point in the figure where each particle density intersects the curve corresponding to the selected run speed and temperature.
- 4 Particles will band at these locations across the tube diameter at equilibrium during centrifugation.

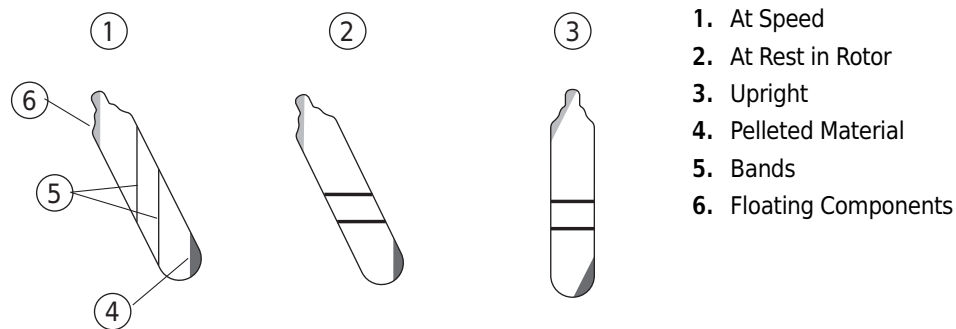

In this example, particles will band about 11.0 and 9.8 mm from the tube bottom, about 1.2 mm of centerband-to-centerband separation at the rotor's 30-degree tube angle. When the tube is held upright, there will be about 1.38 mm of centerband-to-centerband separation. This interband distance, d_{up} , can be calculated from the formula:

EQ 7

$$d_{up} = \frac{d_{\theta}}{\cos \theta}$$

where d_{θ} is the interband distance when the tube is held at an angle, θ , in the rotor.

Example B:

Knowing particle buoyant densities (e.g., 1.55 and 1.57 g/mL), how do you achieve good separation (using open top tubes)?

- 1 In [Figure 5](#), sketch in a horizontal line corresponding to each particle's buoyant density.
- 2 Select the curve at the required temperature (20°C) and fill volume (full) that gives the best particle separation.
- 3 Note the run speed along the selected curve (80,000 RPM).
- 4 From [Figure 4](#) select the maximum homogeneous CsCl density that corresponds to the temperature and run speed established above.
These parameters will provide the particle-banding pattern selected in Step 2.

In this example, particles will band at about 12.8 and 11.8 mm from the bottom of the tube (about 1 mm apart). When the tube is held upright there will be about 1.15 mm of center-of-band to center-of-band separation.

Care and Maintenance

Maintenance

NOTE Do not use sharp tools on the rotor that could cause scratches in the rotor surface. Corrosion begins in scratches and may open fissures in the rotor with continued use.

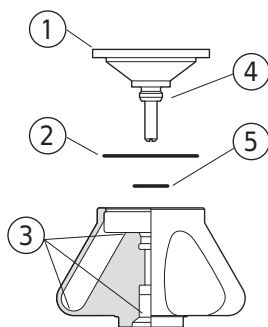

1. Lid Assembly (349478)
2. Lid O-ring (outer) (854521)
3. Check for Corrosion
4. Threads
5. Lid O-ring (inner) (824412)

- 1 Regularly lubricate the metal threads in the rotor plugs with a thin, even coat of Spinkote lubricant.
Failure to keep these threads lubricated can result in damaged threads

-
- 2 Regularly apply silicone vacuum grease to the O-rings.
Replace O-rings about twice a year or whenever worn or damaged.
-

Refer to *Chemical Resistances* (IN-175) for the chemical compatibilities of rotor and accessory materials. Your Beckman Coulter representative provides contact with the Field Rotor Inspection Program and the rotor repair center.

Cleaning

Wash the rotor and rotor components immediately if salts or other corrosive materials are used or if spillage has occurred. Do not allow corrosive materials to dry on the rotor.

Under normal use, wash the rotor frequently (at least weekly) to prevent buildup of residues.

-
- 1 Remove the O-rings before washing.
 - 2 Wash the rotor and lid in a mild detergent, such as Solution 555 (339555), that won't damage the rotor.
Dilute the detergent with water (10 parts water to 1 part detergent).

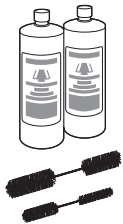

NOTE Do not wash rotor components in a dishwasher. Do not soak in detergent solution for long periods, such as overnight.

The Rotor Cleaning Kit contains two plastic-coated brushes and two quarts of Solution 555 for use with rotors and accessories.

-
- 3 Rinse the cleaned rotor and components with distilled water.
 - 4 Air-dry the rotor and lid upside down.
Do not use acetone to dry the rotor.
 - 5 Apply a thin, even coat of silicone vacuum grease to both lid O-rings before replacing them in the grooves in the lid.
 - 6 Clean metal threads as necessary (at least every 6 months).
 - a. Use a brush and concentrated Solution 555.
 - b. Dilute the detergent with water (10 parts water to 1 part detergent).
 - c. Rinse and dry thoroughly, then lubricate lightly but evenly with Spinkote to coat all threads.
-

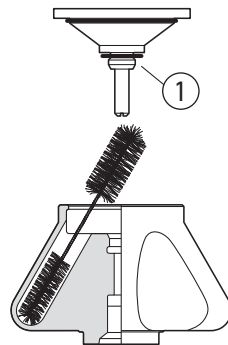

1. Threads

-
- 7** Periodically remove the O-rings and wipe clean as necessary.
- a. Clean the O-ring grooves with a cotton-tipped swab.
 - b. Reapply a light film of silicone vacuum grease.
-

Decontamination



If the rotor or other components are contaminated with radioactive, toxic, or pathogenic materials, follow appropriate decontamination procedures as outlined by appropriate laboratory safety guidelines and/or other regulations. Consult Appendix A in *Rotors and Tubes* to select an agent that will not damage the rotor

Sterilization and Disinfection

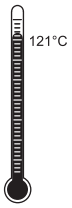

- The rotor and all rotor components can be autoclaved at 121°C for up to one hour. Remove the lid from the rotor and place the rotor, lid, and O-ring in the autoclave upside down.
- Ethanol (70%) or hydrogen peroxide (6%) may be used on all rotor components, including those made of plastic. Bleach (sodium hypochlorite) may be used, but may cause discoloration of anodized surfaces. Use the minimum immersion time for each solution, per laboratory standards.



Ethanol is a flammability hazard. Do not use it in or near operating ultracentrifuges.

While Beckman Coulter has tested these methods and found that they do not damage the rotor or components, no guarantee of sterility or disinfection is expressed or implied. When sterilization or disinfection is a concern, consult your laboratory safety officer regarding proper methods to use.

Storage

When it is not in use, store the rotor in a dry environment (not in the instrument) with the lid removed to allow air circulation so moisture will not collect in the tube cavities.

Returning a Rotor

Before returning a rotor or accessory for any reason, prior permission must be obtained from Beckman Coulter, Inc. A return authorization form is necessary and may be obtained from your local Beckman Coulter office. The return form should contain the following information:

- rotor type and serial number,
- history of use (approximate frequency of use),
- reason for the return,
- original purchase order number, billing number, and shipping number, if possible,
- name and email address of the person to be notified upon receipt of the rotor or accessory at the factory,
- name and email address of the person to be notified about repair costs, etc.

To protect our personnel, it is the customer's responsibility to ensure that all parts are free from pathogens and/or radioactivity. Sterilization and decontamination must be done before returning the parts. Smaller items (such as tubes, bottles, etc.) should be enclosed in a sealed plastic bag.

All parts must be accompanied by a note, plainly visible on the outside of the box or bag, stating that they are safe to handle and that they are not contaminated with pathogens or radioactivity. **Failure to attach this notification will result in return or disposal of the items without review of the reported problem.**

Use the address label printed on the return form when mailing the rotor and/or accessories.

Customers located outside the United States should contact their local Beckman Coulter office.

Supply List

See the Beckman Coulter *Ultracentrifuge Rotors, Tubes & Accessories* catalog (BR-8101, available at www.beckmancoulter.com), call Beckman Coulter Customer Service at 1-800-742-2345 (U.S.A. or Canada), or contact your local Beckman Coulter office for detailed information on ordering parts and supplies. For your convenience, a partial list is given below.

Replacement Rotor Parts

Description	Part Number
TLA-100.3 rotor assembly	349481
Lid assembly	349478
Lid O-ring (outer)	854521
Lid O-ring (inner)	824412
Cap and plunger assembly	349477
Spring	347903
Rotor vise	346133

Other

NOTE For MSDS information, go to the Beckman Coulter website at www.beckmancoulter.com.

Description	Part Number
Tubes and accessories	see Table 1
Tube rack	355872
Quick-Seal Cordless Tube Topper kit, 60 Hz	358312
Quick-Seal Cordless Tube Topper kit, 50 Hz (Europe)	358313
Quick-Seal Cordless Tube Topper kit, 50 Hz (Great Britain)	358314
Quick-Seal Cordless Tube Topper kit, 50 Hz (Australia)	358315
Quick-Seal Cordless Tube Topper kit, 50-Hz (Canada)	367803
Tube Topper rack	348122
OptiSeal tube rack assembly	361638

TLA-100.3 Fixed-Angle Rotor
Supply List

Description	Part Number
Spacer removal tool (for 3.5-mL and 2.0-mL Quick-Seal tubes)	338765
Spacer removal tool (for OptiSeal tubes)	338765
Spacer removal tool (for 3.5-mL and 2.0-mL Quick-Seal tubes)	338765
Tube removal tool	361668
Curved hemostat (6-in.)	927208
Straight hemostat (6-in.)	961519
Fraction Recovery System	342025
Fraction Recovery System Adapter Kit for TL-series tubes	347828
Beckman Coulter CentriTube Slicer	347960
CentriTube Slicer replacement blades (pkg of 10)	348299
CentriTube Slicer adapter (for 13-mm tubes)	354526
Spinkote lubricant (2 oz)	306812
Silicone vacuum grease (1 oz)	335148
Rotor Cleaning Kit	339558
Rotor cleaning brush	347404
Solution 555 (1 qt)	339555

Beckman Coulter, Inc.

Ultracentrifuge Rotor Warranty

All Beckman Coulter ultracentrifuge Fixed Angle, Vertical Tube, Near Vertical Tube, Swinging Bucket, and Airfuge rotors are warranted against defects in materials or workmanship for the time periods indicated below, subject to the Warranty Conditions stated below.

Preparative Ultracentrifuge Rotors	5 years — No Proration
Analytical Ultracentrifuge Rotors	5 years — No Proration
ML and TL Series Ultracentrifuge Rotors	5 years — No Proration
Airfuge Ultracentrifuge Rotors	1 year — No Proration
For Zonal, Continuous Flow, Component Test, and Rock Core Ultracentrifuge Rotors, see separate warranty.	

Warranty Conditions (as applicable)

1. This warranty is valid for the time periods indicated above from the date of shipment to the original Buyer by Beckman Coulter or an authorized Beckman Coulter representative.
2. Maintain one copy of this software for backup purposes (the backup copy shall be supplied by Beckman Coulter);
3. This warranty covers the Beckman Coulter Centrifuge Systems only (including but not limited to the centrifuge, rotor, and accessories) and Beckman Coulter shall not be liable for damage to or loss of the user's sample, non-Beckman Coulter tubes, adapters, or other rotor contents.
4. This warranty is void if the Beckman Coulter Centrifuge System is determined by Beckman Coulter to have been operated or maintained in a manner contrary to the instructions in the operator's manual(s) for the Beckman Coulter Centrifuge System components in use. This includes but is not limited to operator misuse, abuse, or negligence regarding indicated maintenance procedures, centrifuge and rotor classification requirements, proper speed reduction for the high density of certain fluids, tubes, and tube caps, speed reduction for precipitating gradient materials, and speed reduction for high-temperature operation.
5. Rotor bucket sets purchased concurrently with or subsequent to the purchase of a Swinging Bucket Rotor are warranted only for a term co-extensive with that of the rotor for which the bucket sets are purchased.
6. This warranty does not cover the failure of a Beckman Coulter rotor in a centrifuge not of Beckman Coulter manufacture, or if the rotor is used in a Beckman Coulter centrifuge that has been modified without the written permission of Beckman Coulter, or is used with carriers, buckets, belts, or other devices not of Beckman Coulter manufacture.
7. Rotor parts subject to wear, including but not limited to rotor O-rings, VTi, NVT, TLV, MLN, and TLN rotor tube cavity plugs and gaskets, tubing, tools, optical overspeed disks, bearings, seals, and lubrication are excluded from this warranty and should be frequently inspected and replaced if they become worn or damaged.
8. Keeping a rotor log is not mandatory, but may be desirable for maintenance of good laboratory practices.

Repair and Replacement Policies

1. If a Beckman Coulter rotor is determined by Beckman Coulter to be defective, Beckman Coulter will repair or replace it, subject to the Warranty Conditions. A replacement rotor will be warranted for the time remaining on the original rotor's warranty.
2. If a Beckman Coulter centrifuge is damaged due to a failure of a rotor covered by this warranty, Beckman Coulter will supply free of charge (i) all centrifuge parts required for repair (except the drive unit, which will be replaced at the then current price less a credit determined by the total number of revolutions or years completed, provided that such a unit was manufactured or rebuilt by

Beckman Coulter), and (ii) if the centrifuge is currently covered by a Beckman Coulter warranty or Full Service Agreement, all labor necessary for repair of the centrifuge.

3. If a Beckman Coulter rotor covered by this warranty is damaged due to a malfunction of a Beckman Coulter ultracentrifuge covered by an Ultracentrifuge System Service Agreement, Beckman Coulter will repair or replace the rotor free of charge.
4. If a Beckman Coulter rotor covered by this warranty is damaged due to a failure of a Beckman Coulter tube, bottle, tube cap, spacer, or adapter, covered under the Conditions of this Warranty, Beckman Coulter will repair or replace the rotor and repair the instrument as per the conditions in policy point (2) above, and the replacement policy.
5. Damage to a Beckman Coulter rotor or instrument due to the failure or malfunction of a non-Beckman Coulter tube, bottle, tube cap, spacer, or adapter is not covered under this warranty, although Beckman Coulter will assist in seeking compensation under the manufacturer's warranty.

Beckman Coulter will assist in seeking compensation under the manufacturer's warranty.

Disclaimer

IT IS EXPRESSLY AGREED THAT THE ABOVE WARRANTY SHALL BE IN LIEU OF ALL WARRANTIES OF FITNESS AND OF THE WARRANTY OF MERCHANTABILITY AND BECKMAN COULTER, INC. SHALL HAVE NO LIABILITY FOR SPECIAL OR CONSEQUENTIAL DAMAGES OF ANY KIND WHATSOEVER ARISING OUT OF THE MANUFACTURE, USE, SALE, HANDLING, REPAIR, MAINTENANCE, OR REPLACEMENT OF THE PRODUCT.

Factory Rotor Inspection Service

Beckman Coulter, Inc., will provide free mechanical and metallurgical inspection in Indianapolis, Indiana, USA, of any Beckman Coulter rotor at the request of the user. (Shipping charges to Beckman Coulter are the responsibility of the user.) Rotors will be inspected in the user's laboratory if the centrifuge in which they are used is covered by an appropriate Beckman Coulter Service Agreement. Contact your local Beckman Coulter office for details of service coverage or cost.

Before shipping, contact the nearest Beckman Coulter Sales and Service office and request a Returned Goods Authorization (RGA) form and packaging instructions. Please include the complete rotor assembly, with buckets, lid, handle, tube cavity caps, etc. A SIGNED STATEMENT THAT THE ROTOR AND ACCESSORIES ARE NON-RADIOACTIVE, NON-PATHOGENIC, NON-TOXIC, AND OTHERWISE SAFE TO SHIP AND HANDLE IS REQUIRED.

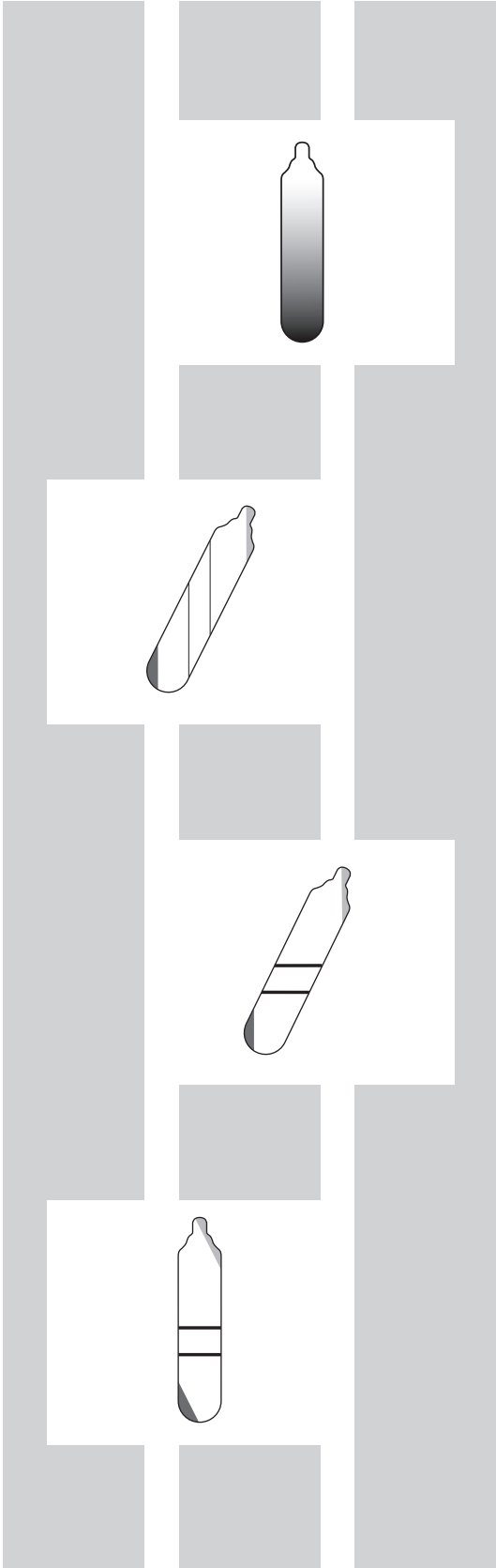

Related Documents

Rotors and Tubes for Beckman Coulter Tabletop Preparative Ultracentrifuges (TLR-IM-9)

- Rotors
- Tubes and Accessories
- Using Tubes and Accessories
- Using Rotors
- Care and Maintenance
- Chemical Resistances
- The Use of Cesium Chloride Curves
- Gradient Materials
- References

Rotors and Tubes CD (369668)

- Rotors and Tubes for Tabletop Preparative Ultracentrifuges
- Rotors and Tubes for J2, J6, Avanti J Series Centrifuges
- Rotors and Tubes for Preparative Ultracentrifuges
- Rotor Safety Bulletin
- Chemical Resistances for Beckman Coulter Centrifugation Products

Included with shipment of instrument.

Additional References

- Chemical Resistances for Beckman Coulter Centrifugation Products (IN-175)
- Ultracentrifuge Rotors, Tubes, and Accessories catalog (BR-8101)

Available in hard copy or electronic pdf by request, also available at www.beckmancoulter.com.

Data Sheets

- Using *k* Factors to Compare Rotor Efficiency (DS-9721A)

Available at www.beckmancoulter.com

www.beckmancoulter.com

