

Allegra® 25R Centrifuge

Instruction Manual

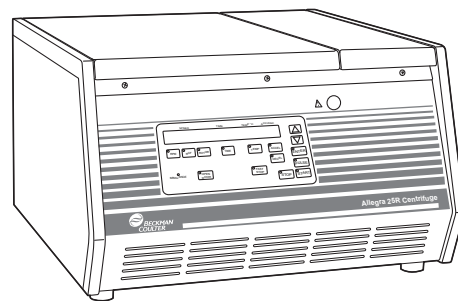

Symbol Symbol Symbole Símbolo	Simbolo 記号 符号 Title / Titel / Titre / Titolo / Titolo / 名称 / 名称
	Dangerous voltage Gefährliche elektrische Spannung Courant haute tension Voltaje peligroso Pericolo: alta tensione 危険電圧 危险电压
	Attention, consult accompanying documents Achtung! Begleitpapiere beachten! Attention, consulter les documents joints Atención, consulte los documentos adjuntos Attenzione: consultare le informazioni allegate 注意、添付資料を参照のこと 注意，请参阅附带的文件
	On (power) Ein (Netzverbindung) Marche (mise sous tension) Encendido Acceso (sotto tensione) 入（電源） 开（电源）
	Off (power) Aus (Netzverbindung) Arrêt (mise hors tension) Apagado Spento (fuori tensione) 切（電源） 关（电源）
	Protective earth (ground) Schutzleiteranschluß Liaison à la terre Puesta a tierra de protección Collegamento di protezione a terra 保護アース（接地） 保护接地
	Earth (ground) Erde Terre Tierra Scarica a terra アース（接地） 接地



SAFETY NOTICE

This safety notice summarizes information basic to the safe operation of the equipment described in this manual. The international symbol displayed above is a reminder that all safety instructions should be read and understood before installation, operation, maintenance, or repair of this centrifuge. When you see the symbol on other pages, pay special attention to the safety information presented. Observance of safety precautions will also help to avoid actions that could damage or adversely affect the performance of the centrifuge.

Safety During Installation and/or Maintenance

This centrifuge is designed to be installed by a Beckman Coulter Field Service representative. Installation by anyone other than authorized Beckman Coulter personnel invalidates any warranty covering the instrument.

This centrifuge weighs 124.0 kg (273.4 lb). Do not attempt to lift or move it without assistance.

Any servicing of this equipment that requires removal of any covers can expose parts that involve the risk of electric shock or personal injury. Make sure that the power switch is off and the centrifuge is disconnected from the main power source, and refer such servicing to qualified personnel.

Do not replace any centrifuge components with parts not specified for use on this instrument.

Electrical Safety

To reduce the risk of electrical shock, this equipment uses a three-wire electrical cord and plug to connect the centrifuge to earth-ground. To preserve this safety feature:

- Make sure that the matching wall outlet receptacle is properly wired and earth-grounded. Check that the line voltage agrees with the voltage listed on the name-rating plate affixed to the centrifuge.
- Never use a three-to-two wire plug adapter.
- Never use a two-wire extension cord or a two-wire non-grounding type of multiple-outlet receptacle strip.

Do not place containers holding liquid on or near the chamber door. If they spill, liquid may get into the centrifuge and damage electrical or mechanical components.

Safety Against Risk of Fire

This centrifuge is not designed for use with materials capable of developing flammable or explosive vapors. Do not centrifuge such materials (such as chloroform or ethyl alcohol)

in this centrifuge nor handle or store them within the 30-cm (1-ft) area surrounding the centrifuge.

Mechanical Safety

For safe operation of the equipment, observe the following:

- Use only the rotors and accessories designed for use in this centrifuge.
- Do not exceed the maximum rated speed of the rotor in use.
- NEVER attempt to slow or stop the rotor by hand.
- Do not lift or move the centrifuge while the rotor is spinning.
- NEVER attempt to override the door interlock system while the rotor is spinning.
- Maintain a 7.6-cm (3-in.) clearance envelope around the centrifuge while it is running. During operation you should come within the envelope only to adjust instrument controls, if necessary. Never bring any flammable substances within the 30-cm (1-ft) area surrounding the centrifuge. Never lean on the centrifuge or place items on the centrifuge while it is operating.

Chemical and Biological Safety

Normal operation may involve the use of solutions and test samples that are pathogenic, toxic, or radioactive. Such materials should not be used in this centrifuge, however, unless *all necessary safety precautions are taken*.

- Observe all cautionary information printed on the original solution containers prior to their use.
- Handle body fluids with care because they can transmit disease. No known test offers complete assurance that they are free of micro-organisms. Some of the most virulent—Hepatitis (B and C) and HIV (I–V) viruses, atypical mycobacteria, and certain systemic fungi—further emphasize the need for aerosol protection. Handle other infectious samples according to good laboratory procedures and methods to prevent spread of disease. Because spills may generate aerosols, observe proper safety precautions for aerosol containment. Do not run toxic, pathogenic, or radioactive materials in this centrifuge without taking appropriate safety precautions. Biosafe containment should be used when Risk Group II materials (as identified in the World Health Organization *Laboratory Biosafety Manual*) are handled; materials of a higher group require more than one level of protection.
- Dispose of all waste solutions according to appropriate environmental health and safety guidelines.

It is your responsibility to decontaminate the centrifuge and accessories before requesting service by Beckman Coulter Field Service.

Allegra® 25R Centrifuge

Instruction Manual

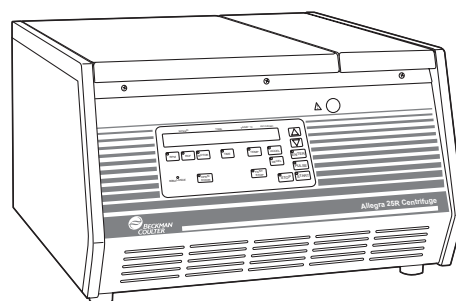

Contents

	Page
INTRODUCTION	
<i>Certification</i>	vii
<i>Scope of Manual</i>	vii
<i>Conventions</i>	viii
<i>Notes, Cautions, and Warnings</i>	viii
<i>Typographic Conventions</i>	ix
<i>CFC-Free Centrifugation</i>	ix
<i>Radio Interference</i>	x
<i>Canadian Regulations</i>	x
<i>Recycling Label</i>	x
SECTION 1: DESCRIPTION	
Centrifuge Function and Safety Features	1-1
Centrifuge Function.	1-1
Safety Features.	1-2
Centrifuge Chassis	1-3
Housing	1-3
Door	1-3
Rotor Chamber.	1-3
Temperature Sensing and Control	1-3
Drive	1-4
Controls and Indicators	1-4
Power Switch.	1-4
Control Panel	1-4
Name Rating Plate	1-7
Specifications	1-8
Available Rotors.	1-9
SECTION 2: PREINSTALLATION REQUIREMENTS	
Space and Location Requirements	2-1
Electrical Requirements	2-2
Transportation Safety Device.	2-3

SECTION 3: OPERATION

Summary of Operating Procedures	3-2
Installing the Rotor	3-3
Setting Run Parameters	3-3
Selecting a Rotor	3-3
Setting Run Speed	3-4
Setting Run Time	3-5
Setting Run Temperature	3-5
Setting Acceleration and Deceleration Rates	3-6
Starting a Run	3-7
Changing Parameters During a Run	3-8
Stopping a Run	3-9

SECTION 4: TROUBLESHOOTING

User Messages	4-1
Other Possible Problems	4-3
Retrieving Your Sample in Case of Power Failure	4-4

SECTION 5: CARE AND MAINTENANCE

General Maintenance	5-1
Cleaning	5-2
Decontamination	5-2
Sterilization and Disinfection	5-3
Storage and Transport	5-3
Supply List	5-4
Replacement Parts	5-4
Supplies	5-4

Warranty

Illustrations

	Page
Figure 1-1. The Allegra 25R Centrifuge	1-2
Figure 1-2. Control Panel	1-4
Figure 2-1. Centrifuge Dimensions.	2-2
Figure 2-2. North American Electrical Socket	2-3
Figure 4-1. Door Latch Override	4-5

Tables

	Page
Table 3-1. Acceleration and Deceleration Rates (in Minutes:Seconds) to and from Maximum Speed.	3-7
Table 4-1. Error Messages.	4-2
Table 4-2. Troubleshooting Chart	4-3

CERTIFICATION

To ensure full system quality, Beckman Coulter Allegra® 25R centrifuges have been manufactured in a registered ISO 9001 or 13485 facility. They have been designed and tested to be compliant (when used with Beckman Coulter rotors) with the laboratory equipment requirements of applicable regulatory agencies. Declarations of conformity and certificates of compliance are available at www.beckmancoulter.com.

SCOPE OF MANUAL

This manual is designed to familiarize you with the Beckman Coulter Allegra 25R centrifuge, its functions, specifications, operation, and routine operator care and maintenance. We recommend that you read this entire manual, especially the SAFETY NOTICE and all safety-related information, before operating the centrifuge or performing instrument maintenance.

- Section 1 contains system specifications and a brief physical and functional description of the centrifuge, including the operating controls and indicators.
- Section 2 provides requirements for preparing laboratory facilities for the centrifuge.
- Section 3 contains centrifuge operating procedures.
- Section 4 lists possible malfunctions, together with probable causes and suggested corrective actions.
- Section 5 contains procedures for routine operator care and maintenance, as well as a brief list of supplies and replacement parts.

 **NOTE**

If the centrifuge is used in a manner other than specified in this manual, the safety and performance of this equipment could be impaired. Further, the use of any equipment other than that recommended by Beckman Coulter has not been evaluated for safety. Use of any equipment not specifically recommended in this manual and/or the appropriate rotor manual is the sole responsibility of the user.

CONVENTIONS

Certain symbols are used in this manual to call out safety-related and other important information. These international symbols may also be displayed on the centrifuge and are reproduced and described below and on the inside of the front cover.

NOTES, CAUTIONS, AND WARNINGS

 **NOTE**

Used to call attention to important information that should be followed during installation, use, or servicing of this equipment



CAUTION

Used to indicate a potentially hazardous situation which, if not avoided, may result in minor or moderate injury and/or mechanical damage. It is also used to alert against unsafe practices.

**WARNING**

Used whenever an action or condition may potentially cause personal injury or loss of life. Mechanical damage may also result.

**WARNING**

Indicates high voltage or risk of electric shock. Refer servicing of all areas displaying this symbol to service personnel.

TYPOGRAPHIC CONVENTIONS

Certain typographic conventions are used throughout this manual to distinguish names of user interface components, such as keys and displays.

- *Key names* (for example, **[START]** or **[ROTOR]**) appear in capital letters within brackets.
- *Display names* (for example, **SPEED** or **TIME**) appear in bold type.

CFC-FREE CENTRIFUGATION



To ensure minimal environmental impact, no CFCs are used in the manufacture or operation of Allegra 25R centrifuges.

RADIO INTERFERENCE

This equipment has been tested and found to comply with the limits for a Class A digital device, pursuant to Part 15 of FCC Rules. These limits are designed to provide reasonable protection against harmful interference when the equipment is operated in a commercial environment. This equipment generates, uses, and can radiate radio frequency energy and, if not installed and used in accordance with this instruction manual, may cause interference to radio communications. Operation of this equipment in a residential area is likely to cause interference, in which case the user will be required to correct the interference at his own expense.

CANADIAN REGULATIONS

This equipment does not exceed the Class A limits for radio noise emissions from digital apparatus as set out in the radio interference regulations of the Canadian Department of Communications.

Le présent appareil numérique n'émet pas de bruits radioélectriques dépassant les limites applicables aux appareils numériques de Classe A prescrites dans le règlement sur le brouillage radioélectrique édicté par le Ministère des Communications du Canada.

RECYCLING LABEL

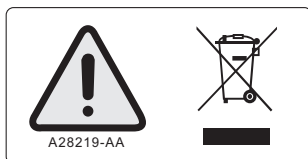

Note: On the instrument, the triangle background is yellow rather than gray.

This symbol is required in accordance with the Waste Electrical and Electronic Equipment (WEEE) Directive of the European Union. The presence of this marking on the product indicates:

- 1) The device was put on the European market after August 13, 2005 and
- 2) The device is not to be disposed via the municipal waste collection system of any member state of the European Union.

It is very important that customers understand and follow all laws regarding the proper decontamination and safe disposal of electrical equipment. For Beckman Coulter products bearing this label please contact your dealer or local Beckman Coulter office for details on the take back program that will facilitate the proper collection, treatment, recovery, recycling and safe disposal of the device.



Description

CENTRIFUGE FUNCTION AND SAFETY FEATURES

CENTRIFUGE FUNCTION

The Beckman Coulter Allegra 25R centrifuge (see Figure 1-1) is a refrigerated benchtop centrifuge that generates centrifugal forces required for a wide variety of applications. Together with the Beckman Coulter rotors designed for use in this centrifuge, the centrifuge applications include:

- Routine processing such as sample preparations, pelleting, extractions, purifications, concentrations, phase separations, receptor binding, and column centrifugations.
- Processing large numbers of small-volume samples in multiwell plates for concentrating tissue-culture cells, cloning and replicate studies, in-vitro cytotoxicity studies, receptor binding, and genetic engineering experimentation.
- Rapid sedimentation of protein precipitates, large particles, and cell debris.
- Binding studies and separation of whole blood.
- Cell isolation.

The Allegra 25R is microprocessor-controlled, providing interactive operation. The instrument design features a brushless asynchronous motor, automatic rotor identification system, temperature control system, and a choice of acceleration and deceleration rates. User messages alert the operator to conditions that may need attention.

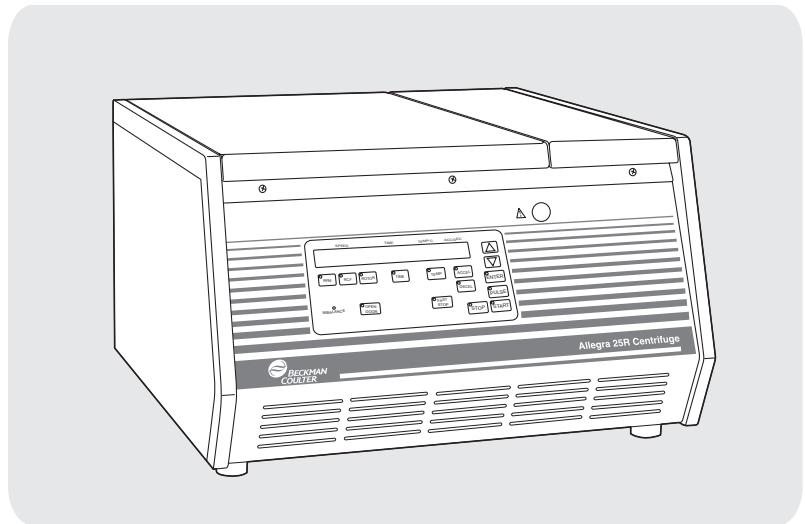

Figure 1-1. The Allegra 25R Centrifuge

SAFETY FEATURES

The centrifuge has been designed and tested to operate safely indoors at altitudes up to 2 000 m (6 562 ft). Safety features include the following.

- An electromechanical door lock system prevents operator contact with spinning rotors and prevents run initiation unless the door is shut and locked. The door is locked when a run is in progress and can be opened only when the rotor is stopped and the LED (light-emitting diode) on the [OPEN DOOR] key is lit.
- An imbalance detector monitors the rotor during the run, causing automatic shutdown if rotor loads are severely out of balance. At low speeds, an incorrectly loaded rotor can cause imbalance. Rotor instability can also occur if the centrifuge is moved while running, or if it is not resting on a level and secure surface.
- To prevent overspeed the microprocessor checks the rotor identification during start-up and stops the run if the rotor is incorrectly identified.

CENTRIFUGE CHASSIS

HOUSING

The centrifuge housing is made of sheet steel and is finished with urethane paint. The control panel overlay is made of coated polycarbonate.

DOOR

The steel door is secured to the housing by solid hinges. When the door is closed, a motorized locking system engages. The door is locked when a run is in progress and can be opened only when the rotor is stopped and the LED on the [**OPEN DOOR**] key is lit. If there is a power failure, the door lock can be manually tripped for sample recovery (see Section 4, Troubleshooting).

ROTOR CHAMBER

The rotor chamber is stainless steel for durability and corrosion resistance. The chamber is sealed by a silicone rubber gasket.

TEMPERATURE SENSING AND CONTROL

With the power on, the temperature control system is activated when the door is closed and locked. Run temperature can be set between -20 and $+40^{\circ}\text{C}$. If no set temperature is entered, the instrument automatically selects the last entered temperature.

A sensor in the rotor chamber continuously monitors chamber temperature. The microprocessor calculates the required chamber temperature to maintain the selected rotor temperature.

NOTE

To avoid chamber icing, refrigeration is off when the door is open. The centrifuge door must be closed and locked for the refrigeration system to begin operating.

DRIVE

The asynchronous direct-drive motor is brushless for clean, quiet operation. A tie-down screw is used to attach the rotor to the drive shaft. The resilient suspension ensures that loads will not be disturbed by vibration, and prevents damage to the drive shaft if an imbalance occurs during centrifugation. Maximum acceleration and deceleration may be selected to allow fast processing of samples; alternately, delicate gradients may be preserved using slower acceleration and deceleration.

CONTROLS AND INDICATORS

POWER SWITCH

The power switch, located on the back panel, controls electrical power to the centrifuge. It is also a circuit breaker that will trip to cut off power in the event of a power overload. The power switch must be turned on before the chamber door can be opened.

CONTROL PANEL

The control panel (see Figure 1-2), mounted at an angle on the centrifuge front for easy visibility and access, comprises touch keys—system keys and parameter keys—and digital displays. The panel also contains an IMBALANCE light that flashes if rotor loads are severely out of balance.

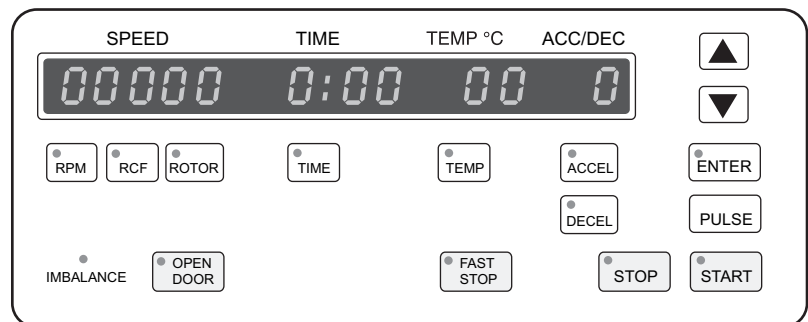

Figure 1-2. Control Panel

System Keys

Centrifuge operation is controlled through the system keys. Each key, except [**PULSE**], has an LED in the upper left corner that lights to indicate operational readiness.

[OPEN DOOR]

Unlocks the electromechanical door lock. The instrument will not accept this command if the rotor is spinning.

[FAST STOP]

Causes the centrifuge to decelerate to a complete stop at the maximum rate; deceleration cannot be interrupted—the centrifuge can be restarted only after the rotor stops and the door is opened and closed.

[STOP]

Can be pressed at any time to terminate a run according to the selected deceleration rate. Deceleration can be terminated and the centrifuge restarted by pressing [**START**] again.

[START]

Causes a timed or continuous run to begin; can also be used to abort deceleration and restart the centrifuge.

[PULSE]

Causes the rotor to accelerate to set speed for short-duration runs (as long as the key is pressed). Deceleration, at maximum rate, begins when the key is released.

Parameter Keys

These keys are used to set up the run. Except for the cursor and [**ENTER**] keys, parameter keys are located beneath the applicable digital displays, which show the parameter values as they are input. Each key (except the cursor keys) has an LED in the upper left corner that lights to indicate operational readiness. The LEDs also blink if an incorrect parameter is entered.

[RPM]

Causes the last digit in the **SPEED** display (0) to flash, indicating that speed can be entered in rpm (revolutions per minute). Corresponding RCF (relative centrifugal force) is calculated and can be displayed during the run.

[RCF]

Selects speed setting by RCF; the corresponding rpm is automatically calculated and displayed during the run. If this key is pressed during the run, the **SPEED** display shows the RCF value.

[ROTOR]

When this key is pressed the number of the rotor used in the previous run is shown on the **SPEED** display. The list can be scrolled through, using the cursor keys, to select a rotor.

- [TIME]** Pressed to select the run duration, using the cursor keys.
- *Timed run*—can be set up to 9 hours, 59 minutes (a minutes parameter exceeding 59 is automatically converted into hours).
 - *Continuous run*—timer is set for less than 0 or more than 9 hours, 59 minutes (by pressing the down cursor key after the display reaches 0, or the up cursor key after the display reaches 9:59).
- [TEMP]** When this key is pressed, the **TEMP°C** display flashes, indicating that the temperature can be entered with the cursor keys. Temperature can be set between -20 and $+40^{\circ}\text{C}$.
- [▲] [▼] (Cursor Keys)** Up and down arrow keys, which can be pressed to increment parameter values up or down.
- [ENTER]** Pressed after each parameter is entered to register the entry. Also pressed to verify parameter changes (speed, time, temperature, and deceleration rate) made during a run in progress.
- [ACCEL]** Enables selection of one of 10 preset acceleration rates (see Table 3-1 in Section 3), available to protect specific gradient and sample-to-gradient interfaces. If no acceleration rate is selected, the centrifuge defaults to maximum acceleration.
- [DECEL]** Enables selection of one of 10 preset deceleration rates (see Table 3-1 in Section 3) available to maintain optimum separation. If no deceleration rate is selected, the centrifuge defaults to maximum deceleration. (Deceleration rate 0 is always coast to complete stop.)

Digital Displays

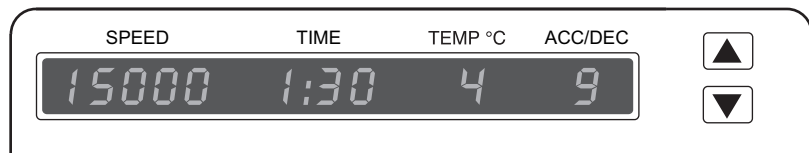

The displays indicate rotor speed, run time, rotor chamber temperature, and numbers representing selected acceleration and deceleration profiles. The displays serve a dual purpose.

- When the run parameters are being entered (input mode), they show the set values selected. When a parameter key is pressed, the appropriate display flashes to indicate that data can be entered.

- During a run, they show the actual (real-time) operating conditions.

SPEED

- Input mode—shows the value of the parameter selected. For example, if the [**ROTOR**] key is pressed, a rotor number appears on the **SPEED** display.
- During a run—shows the rotor speed in rpm. If the [**RCF**] key is pressed while the centrifuge is running, the RCF value is displayed.

NOTE

Error messages (see Section 4) also appear on this display, when applicable.

TIME

- During a timed run (between 1 minute and 9 hours, 59 minutes)—starts counting down when the rotor begins to spin and continues the countdown until deceleration begins.
- During a continuous run (timer set for less than 0 or more than 9 hours, 59 minutes)—the infinity (∞) symbol is displayed and elapsed time since run start is displayed. After 9 hours and 59 minutes the timer resets to 0 and continues counting elapsed time.

TEMP°C

Indicates temperature inside the rotor chamber in °C, within ± 2 degrees of the set temperature (after equilibration).

ACC/DEC

When the [**ACCEL**] key is pressed, the display flashes, indicating that an acceleration rate can be entered; when the [**DECEL**] key is pressed, the flashing display indicates that a number representing the selected deceleration rate can be entered. During operation, the selected deceleration rate is displayed.

NAME RATING PLATE

The name rating plate is affixed to the rear of the centrifuge. Check that the line voltage agrees with the voltage listed on this name rating plate before connecting the centrifuge. Always mention the serial number and the model number shown when corresponding with Beckman Coulter regarding your centrifuge.

SPECIFICATIONS

Only values with tolerances or limits are guaranteed data. Values without tolerances are informative data, without guarantee.

Speed

Set speed to 15 000 rpm in 100-rpm increments
Speed control actual rotor speed, ± 50 rpm of set speed
Speed display actual rotor speed in 100-rpm increments
or in RCF (when selected)

Time

Set time to 9 hours 59 minutes
or continuous (hold)

Time display

Timed run indicates run time remaining
Continuous (hold) or pulse run (∞) indicates elapsed time

Temperature

Set temperature -20 to $+40^{\circ}\text{C}$ in 1° increments
Temperature control (after equilibration) $\pm 2^{\circ}\text{C}$ of set temperature
Temperature display (after equilibration) chamber temperature
in 1° increments

Ambient temperature range 10 to 35°C

Ambient temperature for optimum operation 23°C ($\pm 2^{\circ}\text{C}$)

Humidity restrictions $< 80\%$ (noncondensing)

Acceleration 10 acceleration profiles

Deceleration 10 deceleration profiles

Dimensions

Width 65.0 cm (25.6 in.)

Depth 68.5 cm (27.0 in.)

Height 40.5 cm (16.0 in.)

Weight 124.0 kg (273.4 lb)

Ventilation clearances (sides and rear) 7.6 cm (3.0 in.)

Finishes

Control panel coated polycarbonate

Housing surfaces urethane paint

Electrical requirements

208-V, 60-Hz instrument 187–229 VAC, 16 A, 60 Hz

200-V, 50/60-Hz instrument 190–210 VAC, 16 A, 50/60 Hz

230-V, 50-Hz instrument 207–253 VAC, 13 A, 50 Hz

Electrical supply Class I

Maximum heat dissipation into room under

steady-state conditions 6824 Btu/hr (2.0 kW)

Noise level 0.91 m (3 ft) in front of centrifuge ≤ 68 dBa

Installation (overvoltage) category II

Pollution degree 2*

* Normally only nonconductive pollution occurs; occasionally, however, a temporary conductivity caused by condensation must be expected.

AVAILABLE ROTORS

The following Beckman Coulter rotors can be used in the Allegra 25R centrifuge. The rotors are described in individual manuals that accompany each rotor.

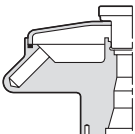
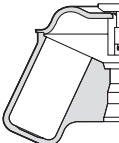
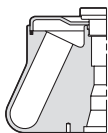
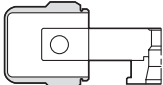
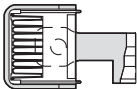
Rotor Profile and Description	Rotor Selection Code	Max RPM*	Max RCF [†] ($\times g$) at r_{\max}	Number of Tubes \times Nominal Capacity	Rotor Manual Number
TA-15-1.5 Fixed Angle  $r_{\max} = 100 \text{ mm}$	A-15	15 000	25 160	30 \times 1.5/2.0 mL	BS-TB-002
TA-10-250 Fixed Angle  $r_{\max} = 137 \text{ mm}$	A-10	10 000	15 300	6 \times 250 mL	BS-TB-003
TA-14-50 Fixed Angle  $r_{\max} = 96 \text{ mm}$	A-14	14 000	21 100	8 \times 50 mL	BS-TB-004
TS-5.1-500 Horizontal  Buckets, $r_{\max} = 190 \text{ mm}$ Microplate carriers, $r_{\max} = 160 \text{ mm}$	S-5.1 BUC5 PLA	5 100 4 100	5 530 3 000	4 \times 500 mL 4 \times 96 mL	BS-TB-005
S5700 Swinging Bucket  $r_{\max} = 168.5$	S-57	5 700	6 130	2 \times 480 mL	BS-TB-006

* Maximum speeds are based on a solution density of 1.2 g/mL.

[†] Relative Centrifugal Field (RCF) is the ratio of the centrifugal acceleration at a specified radius and speed ($r\omega^2$) to the standard acceleration of gravity (g) according to the following formula:

$$\text{RCF} = \frac{r\omega^2}{g}$$

where r is the radius in millimeters, ω is the angular velocity in radians per second ($2\pi \text{ RPM} / 60$), and g is the standard acceleration of gravity (9807 mm/s^2). After substitution:

$$\text{RCF} = 1.12 r \left(\frac{\text{RPM}}{1000} \right)^2$$

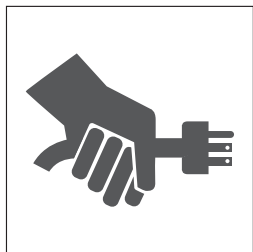

Preinstallation Requirements

The Allegra 25R centrifuge is designed to be installed by Beckman Coulter Field Service. Installation by anyone other than authorized Beckman Coulter personnel invalidates any warranty covering the centrifuge. Preinstallation requirements have been sent prior to shipment of your centrifuge. The following information is provided in case the instrument must be relocated.

SPACE AND LOCATION REQUIREMENTS



WARNING

Do not place the centrifuge near areas containing flammable reagents or combustible fluids. Vapors from these materials could enter the centrifuge air system and be ignited by the motor.

- Select a location away from heat-producing laboratory equipment, with sufficient ventilation to allow for heat dissipation.
- Position the centrifuge on a level surface, such as a sturdy table or laboratory bench that can support the weight of the centrifuge (124.0 kg/273.4 lb) and resist vibration.
- Relative humidity should not exceed 80% (noncondensing).
- In addition to space for the centrifuge itself (see Figure 2-1 for dimensions), allow 7.6-cm (3-in.) clearances at the sides and back of the centrifuge to ensure sufficient air circulation. The centrifuge must have adequate air ventilation to ensure compliance to local requirements for vapors produced during operation.

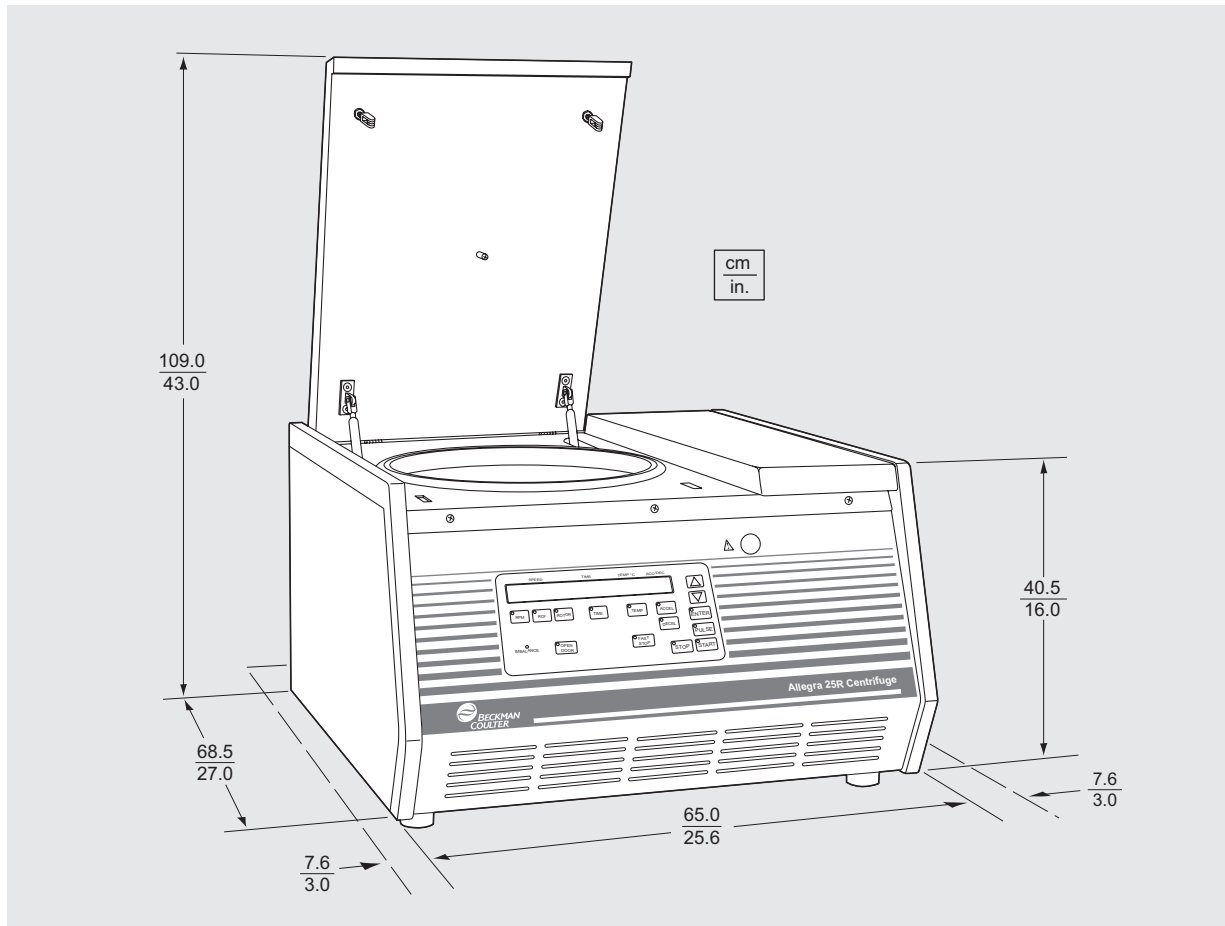

Figure 2-1. Centrifuge Dimensions

ELECTRICAL REQUIREMENTS

208-V, 60-Hz centrifuge	187–229 VAC, 16 A, 60 Hz
200-V, 50/60-Hz centrifuge	190–210 VAC, 16 A, 50/60 Hz
230-V, 50-Hz centrifuge	207–253 VAC, 13 A, 50 Hz

To reduce the risk of electrical shock, this centrifuge uses a 1.8-m (6-ft) three-wire electrical cord (attached to the power connector at the rear of the centrifuge) and plug to connect the centrifuge to earth-ground. The plug for use in North America is the NEMA 6-20P; a NEMA 6-20R socket (see Figure 2-2) should be available. (Contact Beckman Coulter field service for specific information regarding local requirements.) To preserve this safety feature:

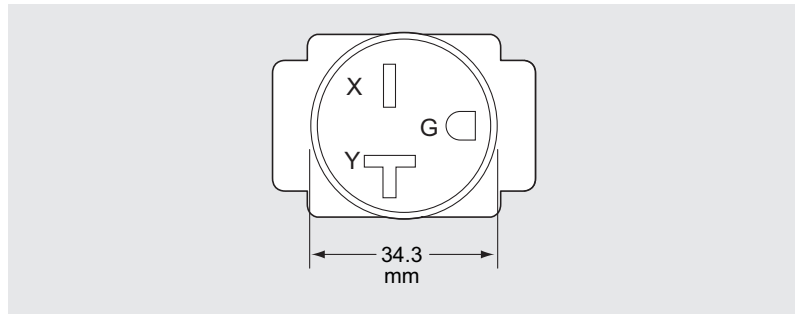

Figure 2-2. North American Electrical Socket

- Make sure that the matching wall outlet receptacle is properly wired and earth-grounded. Check that the line voltage agrees with the voltage listed on the name rating plate affixed to the centrifuge.
- Never use a three-to-two wire plug adapter.
- Never use a two-wire extension cord or a two-wire non-grounding type of multiple-outlet receptacle strip.
- If there is any question about voltage, have a qualified service person measure it under load while the drive is operating.

To ensure safety the centrifuge should be wired to a remote emergency switch (preferably outside the room where the centrifuge is housed, or adjacent to the exit from that room), in order to disconnect the centrifuge from the main power source in case of a malfunction.

TRANSPORTATION SAFETY DEVICE

The centrifuge is shipped with a transportation safety device (368248) installed on the instrument bottom to prevent damage to the drive motor during transit. When installation of the centrifuge is complete, the Beckman Coulter Field Service representative will remove the transport device. Save it to use during future relocation of the centrifuge.

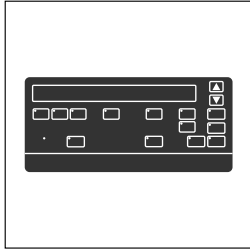

This section contains centrifuge operating procedures. A summary is provided at the start of this section. If you are an experienced user of this centrifuge, you can turn to the summary for a quick review of operating steps. Refer to the applicable rotor manual for instructions on preparing the rotor for centrifugation.





WARNING

Handle body fluids with care because they can transmit disease. No known test offers complete assurance that they are free of micro-organisms. Some of the most virulent—Hepatitis (B and C) and HIV (I–V) viruses, atypical mycobacteria, and certain systemic fungi—further emphasize the need for aerosol protection. Handle other infectious samples according to good laboratory procedures and methods to prevent spread of disease. Because spills may generate aerosols, observe proper safety precautions for aerosol containment. Do not run toxic, pathogenic, or radioactive materials in this centrifuge without taking appropriate safety precautions. Biosafe containment should be used when Risk Group II materials (as identified in the World Health Organization *Laboratory Biosafety Manual*) are handled; materials of a higher group require more than one level of protection.

Do not use the centrifuge in the vicinity of flammable liquids or vapors, and do not run such materials in the instrument. Do not lean on the centrifuge or place items on it while it is operating.

SUMMARY OF OPERATING PROCEDURES

For runs at other than room temperature, refrigerate or warm the rotor beforehand for fast equilibration.

1	[OPEN DOOR]	With the power switch on, press [OPEN DOOR] and open the chamber door.
2		Install the rotor according to the applicable rotor manual. <i>Always run the rotor with a balanced load.</i> Close the chamber door.
3	[ROTOR], [▲] or [▼], [ENTER]	Select a rotor number.
4	[RPM], [▲] or [▼], [ENTER]; <i>or</i> [RCF], [▲] or [▼], [ENTER]	Set run speed.
5	[TIME], [▲] or [▼], [ENTER]	Set run duration.
6	[TEMP], [▲] or [▼], [ENTER]	Set temperature.
7	[ACCEL], [▲] or [▼], [ENTER]	Select acceleration rate. (You can skip this step and accept the default acceleration rate, which is maximum acceleration.)
8	[DECEL], [▲] or [▼], [ENTER]	Select deceleration rate. (You can skip this step and accept the default deceleration rate, which is maximum deceleration.)
9	[START]	<p>Check that all parameters are correct and that the door is closed, then press [START].</p> <p> CAUTION _____</p> <p><i>Do not lift or move the centrifuge while the rotor is spinning.</i></p> <p>_____</p>
10	[STOP]	Wait for the set time to count down to zero, or end the run by pressing [STOP] or [FAST STOP].
11	[OPEN DOOR]	When the rotor stops spinning, press [OPEN DOOR] to remove the rotor. Unload the rotor according to the applicable rotor manual.

INSTALLING THE ROTOR

Prepare the rotor for centrifugation as described in the applicable rotor manual. For fast temperature equilibration, cool or warm the rotor to the required temperature before the run. Recommended precool period is 30 minutes at 2000 rpm for fixed angle rotors or 1000 rpm for swinging bucket rotors, with the temperature set to 0°C.

<i>Action</i>	<i>Result</i>
1. Press [OPEN DOOR] to unlock the door.	The centrifuge will not accept this command unless the rotor is at rest and the [OPEN DOOR] LED is lit.
2. Install the rotor according to the rotor manual.	
3. Gently close the chamber door (the automatic latching mechanism engages when the door is nearly closed).	

SETTING RUN PARAMETERS

SELECTING A ROTOR

Make sure the rotor is seated on the drive shaft and the tie-down screw is tight before each run.

<i>Action</i>	<i>Result</i>
1. Press [ROTOR].	The number of the rotor used in the previous run appears.
2. Press [▲] or [▼] until the correct rotor number appears.	Rotor numbers are scrolled on the SPEED display.



||||➔ **NOTE**

If you select the TS-5.1-500 rotor (selection code S-5.1) a submenu will appear. Select BUC5 for buckets or PLA for microplate carriers.

Action

3. When the selected rotor number is displayed, press [ENTER].

Result

Rotor number will be shown in the **SPEED** display. You can set parameters for the run.

SETTING RUN SPEED

You can set centrifuge speed, in either rpm or RCF, for up to the maximum rated speed of the selected rotor.

Setting RPM

Action

1. Press [RPM].

Result

The last digit on the **SPEED** display flashes.

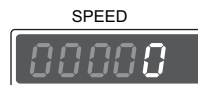

2. Press [▲] or [▼] until the required speed appears, then press [ENTER].

During centrifugation, the **SPEED** display shows the actual run speed of the rotor in rpm. The corresponding RCF will be automatically calculated by the centrifuge.

Setting RCF

Action

1. Press [**RCF**].

Result

The last digit on the **SPEED** display flashes.

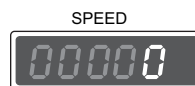

2. Press [**▲**] or [**▼**] until the required RCF appears, then press [**ENTER**].

The corresponding rpm will be automatically calculated and the centrifuge will run at the calculated speed. You can check the RCF during the run by pressing [**RCF**] while the centrifuge is running.

SETTING RUN TIME

You can set run time up to 9 hours and 59 minutes.

Action

1. Press [**TIME**].

Result

The last digit on the **TIME** display flashes.



2. Press [**▲**] or [**▼**] until the required time appears, then press [**ENTER**].

- *Timed run*—set a time between 1 minute and 9 hours, 59 minutes. If you enter a number between 59 and 99 minutes, the centrifuge automatically recalculates the time in hours and minutes.
- *Continuous*—set a time below 0 or above 9:59.

SETTING RUN TEMPERATURE

You can set run temperature from -20 to $+40^{\circ}\text{C}$. If no value is entered, the centrifuge automatically selects the last entered temperature. (If all previous entries have been cleared, 25°C is selected as the operating temperature.)

Action

1. Press [TEMP].
2. Press [▲] or [▼] until the required temperature appears, then press [ENTER].

Result

The last digit of the TEMP °C display flashes.
Entered temperature appears on the TEMP °C display.

SETTING ACCELERATION AND DECELERATION RATES

You can select one of ten acceleration rates and ten deceleration rates to protect the gradient and sample-to-gradient interface. Select rates depending on the type of run you are performing—for pelleting runs, where sample mixing is not a concern, maximum deceleration can be used. If running delicate gradients, a lower setting may be needed. Typical acceleration and deceleration rates are listed in Table 3-1. If no rate is selected, the centrifuge automatically accelerates and decelerates at maximum.

Setting Acceleration Rate

Action

1. Press [ACCEL].
2. Press [▲] or [▼] until the required acceleration rate appears, then press [ENTER].

Result

The ACC/DEC display flashes.



Entered number appears on the ACC/DEC display.

Table 3-1. Acceleration and Deceleration Rates (in Minutes:Seconds) to and from Maximum Speed. Times shown are for the TS-5.1-500 rotor, with the rotor fully loaded, to/from maximum rotor speed of 5000 rpm. (Times are approximate; actual times will vary depending on the rotor in use, the rotor load, run speed, and voltage fluctuations.)

Accel/Decel Rate	Accel	Decel
9	00:59	00:57
8	01:19	01:17
7	01:39	01:37
6	01:59	01:57
5	02:19	02:17
4	03:19	02:37
3	03:59	02:57
2	04:19	03:17
1	04:39	03:27
0	04:59	coast

Setting Deceleration Rate

Action

1. Press [DECEL].

Result

The ACC/DEC display flashes.



2. Press [▲] or [▼] until the required deceleration rate appears, then press [ENTER].

Entered number appears on the ACC/DEC display.

STARTING A RUN

You can start the run with parameters in memory from the previous run, or using new or changed parameters that you enter using the procedure described above.

Action

1. Check that all parameters are correct and the door is closed.

2. Press [**START**].

Result



CAUTION

Do not lift or move the centrifuge while the rotor is spinning.

- The **SPEED** display indicates rotor speed in rpm. (You can check the RCF by pressing the [**RCF**] key.)
- A blinking LED at the bottom of the **TIME** display indicates that the run is in progress. This display also shows the remaining run time in hours and minutes for a timed run (when the **TIME** display reaches 0, the run ends); or the infinity symbol (∞) and time elapsed since the run start for a continuous run. (When the elapsed time reaches 9 hours, 59 minutes during a continuous run, it resets to 0 and continues counting until [**STOP**] or [**FAST STOP**] is pressed.)
- The **ACC/DEC** display shows the deceleration rate selected for the run.



WARNING

Do not attempt to override the door interlock system while the rotor is spinning.

CHANGING PARAMETERS DURING A RUN

While a run is in progress, parameters can be altered without stopping the run:

- Speed can be decreased or increased, not to exceed the maximum rated rotor speed.
- Temperature can be decreased or increased.
- Time can be changed from a specified time period to continuous, or a continuous run can be changed to a timed run.
- Run duration of a timed run can be shortened or extended.

- Deceleration rate can be changed until deceleration begins. (The deceleration rate cannot be changed while the rotor is decelerating.)

Use the parameter keys as described under **SETTING RUN PARAMETERS**, above. You must press **[ENTER]** after you input each parameter change. For example, you would change run speed during centrifugation as follows.

Action

1. Press **[RPM]**.

Result

The **SPEED** display flashes.

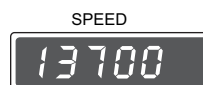

2. Press **[▲]** or **[▼]** until the selected speed appears.
3. Press **[ENTER]**.

The current run speed will be displayed, changing to the new value as the rotor accelerates or decelerates to the new speed selected. The centrifuge will automatically calculate the corresponding RCF.

STOPPING A RUN

A timed run ends automatically when the **TIME** display counts down to zero. To end a timed or continuous run in progress for any reason:

Action

1. Press **[STOP]**.
(or)
[FAST STOP].

Result

Normal deceleration begins, as selected by the deceleration rate.

Deceleration begins at the maximum rate (see Table 3-1). Deceleration cannot be interrupted; the centrifuge can be restarted only after the rotor comes to a complete stop and the door is opened and closed.

Action

2. *After the rotor stops spinning*, press [**OPEN DOOR**].

Result

The door can be opened.



CAUTION

3. Remove the rotor according to the rotor manual.

If disassembly reveals evidence of leakage, you should assume that some fluid escaped the rotor. Apply appropriate decontamination procedures to the centrifuge and accessories.



Troubleshooting

This section lists possible malfunctions, together with probable causes and corrective actions. Maintenance procedures are given in Section 5. For any problems not covered here, contact Beckman Coulter Field Service (1-800-742-2345 in the United States; worldwide offices are listed on the inside back cover of this manual) for assistance.

NOTE

It is your responsibility to decontaminate the instrument, as well as any rotors and/or accessories, before requesting service by Beckman Coulter Field Service.

USER MESSAGES

If a problem occurs during operation, the rotor will decelerate to a stop and an error code will appear on the **SPEED** display. Messages may result from incorrect input (such as exceeding allowable speed for a rotor) or from an equipment malfunction. Refer to Table 4-1 to determine the nature of the problem. If you are unable to correct the problem, call Beckman Coulter Field Service. To help diagnose and correct the problem, provide as much information as possible:

- Write down the error number that appears on the display.
- Note the operating situation when the error occurred (rotor in use, speed, load type, and so forth).
- Note any unusual environmental and/or operating conditions (ambient temperature, voltage fluctuations, and so forth).
- Include any other useful information.

Table 3-1. Error Messages

Error Number	Problem	Result	Recommended Action
1 through 62, 69 through 77	Microprocessor or mechanical error	Deceleration to full stop; run cannot be restarted until error is cleared	After rotor comes to a complete stop turn the power off, then wait 15 seconds before turning it back on to reset.
78	Error during closing of door	Run cannot start	<ol style="list-style-type: none"> 1. Remove debris from latch. 2. Close the door, pressing down gently. 3. Turn the power off, then wait 15 seconds before turning it back on to reset.
81	Door open detected during run	Maximum deceleration to full stop	After rotor comes to a complete stop, close the centrifuge door, turn the power off, then wait 15 seconds before turning it back on to reset.
82, 83	Door latch malfunction	Door does not open	See RETRIEVING YOUR SAMPLE, below.
84	Thermal cutoff switch activated	Deceleration to full stop	<ol style="list-style-type: none"> 1. Turn the power off. 2. Check that ambient temperature is within the specified limits (10 to 35°C). 3. Check, for air inlet and exhaust vent obstruction. Clean air inlets and exhaust vents. 4. After the motor has cooled down (approximately 15 minutes with the door open), turn the power on to reset the thermal protector circuit.
85, 87	Chamber overtemperature	Deceleration to full stop	<ol style="list-style-type: none"> 1. Turn the power off. 2. Check that ambient temperature is within the specified limits (10 to 35°C). 3. Check for air inlet and exhaust vent obstruction. Clean air inlets and exhaust vents. 4. After the motor has cooled down (approximately 15 minutes with the door open), turn the power on to reset the thermal protector circuit.
90 through 96	Defective sensor	Deceleration to full stop	Turn the power off, then wait 15 seconds before turning it back on to reset.
98, 99	Incorrect rotor identification	Deceleration to full stop	Input correct rotor identification.

OTHER POSSIBLE PROBLEMS

Possible malfunctions that may not be indicated by diagnostic messages are described in Table 4-2, along with probable causes, listed in the probable order of occurrence, and corrective actions. Perform the recommended corrective action in sequence, as listed. If you are unable to correct the problem, call Beckman Coulter Field Service.

Table 3-2. Troubleshooting Chart

Problem	Problem/Result	Recommended Action
Imbalance LED lights and rotor decelerates to stop	Rotor is out of balance	Check to be sure the rotor is in good condition and is loaded symmetrically around the center of rotation, with containers of equal weight and density opposite each other.
	Rotor tie-down screw is not properly fastened	Make sure rotor lid is properly aligned and tie-down screw is securely fastened.
	Centrifuge is misaligned (tilted)	Level the centrifuge on the bench or table.
	Centrifuge was moved during operation	After the rotor comes to a complete stop, open and close the centrifuge door, then restart.
	Drive error (mechanical damage)	Call Beckman Coulter Field Service.
Rotor cannot achieve set speed	Line voltage below rating	Have a qualified service person measure line voltage while the instrument is operating.
	Electrical failure	Make sure the power cord is securely connected; call Beckman Coulter Field Service.
	Motor failure	Call Beckman Coulter Field Service.
Door will not open	Rotor spinning	Wait until the rotor stops.
	Power not on	Plug in the power cord; turn power on.
	Source power failure	See RETRIEVING YOUR SAMPLE, below.
	Latch stuck	See RETRIEVING YOUR SAMPLE, below.
Displays are blank	Power not on	Plug in the power cord; turn power on.
	Electrical failure	Make sure the power cord is securely connected; call Beckman Coulter Field Service.
Chamber does not reach selected temperature	Centrifuge cannot maintain selected temperature for rotor in use at speed selected	Refer to applicable rotor manual for temperature and speed requirements. Also, precool rotors before running at low temperatures. Precool rotor chamber by running a 30-minute cycle at the required temperature with the speed set at 2000 rpm.

RETRIEVING YOUR SAMPLE IN CASE OF POWER FAILURE

If facility power fails only momentarily, the centrifuge will resume operation when power is restored and the rotor will return to set speed. However, if the rotor comes to a complete stop, you will have to restart the run when the power is restored. In the event of an extended power failure, it may be necessary to trip the door-locking mechanism manually to remove the rotor and retrieve your sample.

Action

1. Turn the power off and disconnect the power cord from the main power source.

2. Make sure that the rotor is not spinning.

3. Use a small flat screwdriver to remove the cover from the override key opening on the front panel (see Figure 4-1).

4. Insert the supplied override key into the opening and turn it to the right (clockwise).

5. Reinsert the cover in the override key opening.
Turn the power back on.

Result

No displays or LEDs are lit.

No sound or vibration comes from the centrifuge.



WARNING

Never attempt to override the door interlock system while the rotor is spinning.



WARNING

Never attempt to slow or stop the rotor by hand.

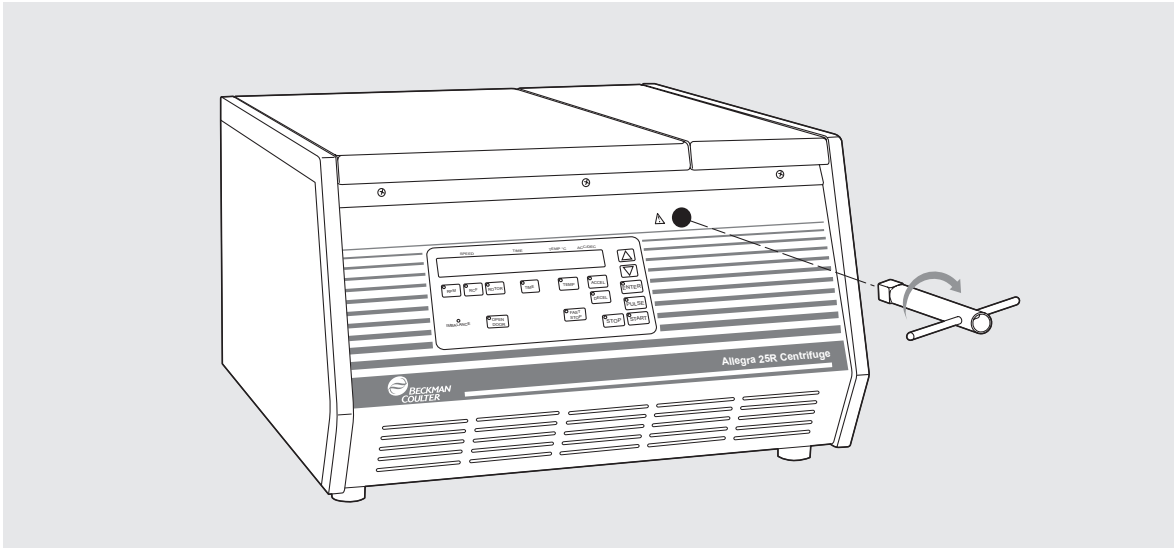

*Figure 4-1. Door Latch Override.
(A 10-mm square-head socket wrench can be used if the provided override key is unavailable.)*

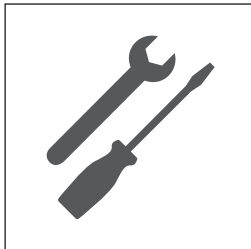

Care and Maintenance

This section contains care and maintenance procedures that should be performed regularly. For maintenance not covered in this manual, contact Beckman Coulter Field Service (1-800-742-2345 in the United States; worldwide offices are listed on the inside back cover of this manual) for assistance. User messages and recommended actions are discussed in Section 4, TROUBLESHOOTING.

||||▶ **NOTE**

It is your responsibility to decontaminate the centrifuge, as well as any rotors and/or accessories, before requesting service by Beckman Coulter Field Service.

GENERAL MAINTENANCE

Perform the following procedures regularly to ensure satisfactory performance and long service life of the centrifuge.

- At least once a week (depending on usage) inspect the rotor chamber for accumulations of sample, dust, and glass particles from broken sample tubes. Clean as required (see CLEANING, below), as these accumulations can result in rotor vibrations.
- Regularly check the air intake and exhaust vents for obstructions. Keep vents clear and clean.
- To prevent the rotor from sticking, lubricate the drive shaft with Spinkote (306812) at least once a month, and after each cleaning.
- Refer to the applicable rotor manual for instructions on the care of rotors and other components and accessories.

CLEANING

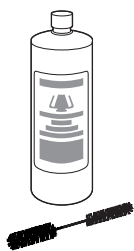

Frequent cleaning will ensure proper operation and prolong the life of the centrifuge. *Always clean up spills when they occur to prevent corrosives or contaminants from drying on component surfaces.* (Be careful not to spill liquid on the instrument where electrical or mechanical components could become damaged.)

- Remove the rotor from the centrifuge often (at least weekly, depending on usage) and clean the bowl, drive shaft, and tie-down screw using a mild detergent such as Beckman Solution 555™ (339555) and a soft brush. Dilute the detergent 10 to 1 with water. Rinse thoroughly and dry completely. Lubricate the drive shaft with Spinkote (306812) after cleaning.
- Keep the interior of the rotor chamber clean and dry by frequent wiping with a cloth or paper towel. To prevent accumulations of sample, dust, and/or glass particles from broken sample tubes from damaging rotor pins (causing rotor vibrations), remove the rotor and clean the chamber often. Spray the centrifuge chamber with an antistatic solution and wipe it clean. (Or use an antistatic wipe.)
- Clean the centrifuge case and door by wiping with a damp cloth or washing with Solution 555. Do not use acetone or other solvents.

NOTE

Before using any cleaning or decontamination methods except those recommended by the manufacture, users should check with the manufacturer that the proposed method will not damage the equipment.

DECONTAMINATION



If the centrifuge and/or accessories are contaminated with radioactive or pathogenic solutions, follow appropriate decontamination procedures as determined by your laboratory safety officer. Refer to *Chemical Resistances* (publication IN-175) to ensure that the decontamination method does not damage any part of the instrument or accessories.

STERILIZATION AND DISINFECTION

The centrifuge housing surfaces are finished with urethane paint. Ethanol (70%)¹ may be used on these surfaces. See *Chemical Resistances* for more information regarding chemical interactions of instrument and accessory materials.

While Beckman Coulter has tested these methods and found that they do not damage the instrument, no guarantee of sterility or disinfection is expressed or implied. When sterilization or disinfection is a concern, consult your laboratory safety officer regarding proper methods to use.

STORAGE AND TRANSPORT

To ensure that the centrifuge does not get damaged, contact Beckman Coulter Field Service for specific instructions and/or assistance in preparing the equipment for transport or long-term storage. Temperature and humidity requirements for storage should meet the environmental requirements described under SPECIFICATIONS in Section 1 of this manual. Install the transportation safety device (removed during centrifuge installation) to prevent damage to the drive motor during transit.

¹ Flammability hazard. Do not use in or near operating centrifuges.

SUPPLY LIST

Contact Beckman Coulter Sales (1-800-742-2345 in the United States; worldwide offices are listed on the inside back cover of this manual) for information about ordering parts, supplies, and publications. A partial list is given below for your convenience.

REPLACEMENT PARTS

Door latch override key.	368247
Rotor tie-down screw	368245
T-handle wrench (rotor fastening).	368246

SUPPLIES

Spinkote lubricant (2 oz).	306812
Silicone vacuum grease (1 oz)	335148
Beckman Solution 555 (1 qt)	339555

ALLEGRA 25R CENTRIFUGE WARRANTY

Subject to the exceptions and upon the conditions specified below and the warranty clause of the Beckman Coulter, Inc. terms and conditions in effect at the time of sale, Beckman Coulter agrees to correct either by repair or, at its election, by replacement, any defects of material or workmanship which develop within one (1) year after delivery of an Allegra 25R centrifuge (the product), to the original buyer by Beckman Coulter or by an authorized representative, provided that investigation and factory inspection by Beckman Coulter discloses that such defect developed under normal and proper use.

Some components and accessories by their nature are not intended to and will not function for as long as one (1) year. A complete list of such components or accessories is maintained at the factory and at each Beckman Coulter District Sales Office. The lists applicable to the products sold hereunder shall be deemed to be part of this warranty. If any such component or accessory fails to give reasonable service for a reasonable period of time, Beckman Coulter will repair or, at its election, replace such component or accessory. What constitutes either reasonable service and a reasonable period of time shall be determined solely by Beckman Coulter.

REPLACEMENT

Any product claimed to be defective must, if requested by Beckman Coulter, be returned to the factory, transportation charges prepaid, and will be returned to Buyer with the transportation charges collect unless the product is found to be defective, in which case Beckman Coulter will pay all transportation charges.

CONDITIONS

Beckman Coulter shall be released from all obligations under all warranties, either expressed or implied, if the product(s) covered hereby are repaired or modified by persons other than its own authorized service personnel, unless such repair in the sole opinion of Beckman Coulter is minor, or unless such modification is merely the installation of a new Beckman Coulter plug-in component for such product(s).

DISCLAIMER

IT IS EXPRESSLY AGREED THAT THE ABOVE WARRANTY SHALL BE IN LIEU OF ALL WARRANTIES OF FITNESS AND OF THE WARRANTY OF MERCHANTABILITY AND THAT NEITHER BECKMAN COULTER, INC. NOR ITS SUPPLIERS SHALL HAVE ANY LIABILITY FOR SPECIAL OR CONSEQUENTIAL DAMAGES OF ANY KIND WHATSOEVER ARISING OUT OF THE MANUFACTURE, USE, SALE, HANDLING, REPAIR, MAINTENANCE, OR REPLACEMENT OF THE PRODUCT.



Beckman Coulter, Inc. • 250 S. Kraemer Blvd. • Brea, California 92821
Sales and Service: 1-800-742-2345 • Internet: www.beckmancoulter.com

©2009 Beckman Coulter, Inc.
All rights reserved

