

Instructions For Use

Rotors and Tubes

For Beckman Coulter
Tabletop Preparative Ultracentrifuges

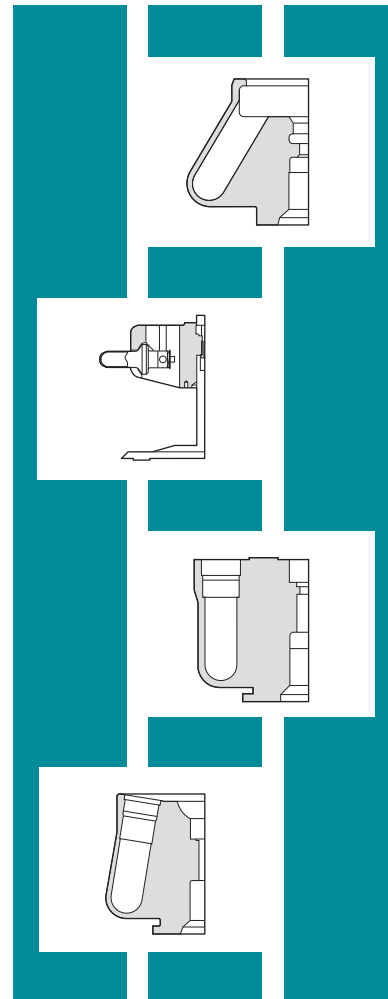

TLR-IM-9AC
February 2014



Beckman Coulter, Inc.
250 S. Kraemer Blvd.
Brea, CA 92821 U.S.A.



**Rotors and Tubes
For Beckman Coulter Tabletop Preparative
Ultracentrifuges**

TLR-IM-9AC (February 2014)

© 2011-2014 Beckman Coulter, Inc.
All rights reserved.

No part of this document may be reproduced or transmitted in any form or by any means, electronic, mechanical, photocopying, recording, or otherwise, without prior written permission from Beckman Coulter, Inc.

Beckman Coulter, Optima, Quick-Seal and the stylized logo are trademarks of Beckman Coulter, Inc. and are registered in the USPTO.

All other trademarks, service marks, products, or services are trademarks or registered trademarks of their respective holders.

Find us on the World Wide Web at:
www.beckmancoulter.com

Printed in U.S.A.

Safety Notice

Read all product manuals and consult with Beckman Coulter-trained personnel before attempting to operate instrument. Do not attempt to perform any procedure before carefully reading all instructions. Always follow product labeling and manufacturer's recommendations. If in doubt as to how to proceed in any situation, contact your Beckman Coulter Representative.

Alerts for Danger, Warning, Caution, Important, and Note



DANGER indicates an imminently hazardous situation which, if not avoided, will result in death or serious injury.



WARNING indicates a potentially hazardous situation which, if not avoided, could result in death or serious injury.



CAUTION indicates a potentially hazardous situation, which, if not avoided, may result in minor or moderate injury.

IMPORTANT IMPORTANT is used for comments that add value to the step or procedure being performed. Following the advice in the Important adds benefit to the performance of a piece of equipment or to a process.

NOTE NOTE is used to call attention to notable information that should be followed during installation, use, or servicing of this equipment.

This safety notice summarizes information basic to the safe operation of the rotors and accessories described in this manual. The international symbol displayed above is a reminder that all safety instructions should be read and understood before use or maintenance of rotors or accessories. When you see the symbol on other pages, pay special attention to the safety information presented. Also observe any safety information contained in applicable rotor and centrifuge manuals. Observance of safety precautions will help to avoid actions that could cause personal injury, as well as damage or adversely affect the performance of the centrifuge/rotor/tube system.

Chemical and Biological Safety

Normal operation may involve the use of solutions and test samples that are pathogenic, toxic, or radioactive. Such materials should not be used in these rotors, however, *unless all necessary safety precautions are taken.*

- Observe all cautionary information printed on the original solution containers prior to their use.
- Handle body fluids with care because they can transmit disease. No known test offers complete assurance that they are free of micro-organisms. Some of the most virulent—Hepatitis (B and C) and HIV (I–V) viruses, atypical mycobacteria, and certain systemic fungi—further emphasize the need for aerosol protection. Handle other infectious samples according to good laboratory procedures and methods to prevent spread of disease. Because spills may generate aerosols, observe proper safety precautions for aerosol containment. Do not run toxic, pathogenic, or radioactive materials in the rotor without taking appropriate safety precautions. Biosafe containment should be used when Risk Group II materials (as identified in the World Health Organization *Laboratory Biosafety Manual*) are handled; materials of a higher group require more than one level of protection.
- Dispose of all waste solutions according to appropriate environmental health and safety guidelines.
- If disassembly reveals evidence of leakage, you should assume that some fluid escaped the container or rotor. Apply appropriate decontamination procedures to the centrifuge, rotor, and accessories.

Mechanical Safety

- Use only the rotors, components, and accessories designed for use in the rotor and centrifuge being used (refer to the applicable rotor manual). *The safety of rotor components and accessories made by other manufacturers cannot be ascertained by Beckman Coulter. Use of other manufacturers' components or accessories in Beckman Coulter rotors may void the rotor warranty and should be prohibited by your laboratory safety officer.*
- Rotors are designed for use at the speeds indicated; however, speed reductions may be required because of weight considerations of tubes, adapters, and/or the density of the solution being centrifuged. Be sure to observe the instructions in the applicable rotor manual.
- NEVER attempt to slow or stop a rotor by hand.
- The strength of containers can vary between lots, and will depend on handling and usage. We highly recommend that you pretest them in the rotor (using buffer or gradient of equivalent density to the intended sample solution) to determine optimal operating conditions. Scratches (even microscopic ones) significantly weaken glass and polycarbonate containers.

To help prevent premature failures or hazards by detecting stress corrosion, metal fatigue, wear or damage to anodized coatings, and to instruct laboratory personnel in the proper care of rotors, Beckman Coulter offers the Field Rotor Inspection Program (FRIP). This program involves a visit to your laboratory by a specially trained Beckman Coulter representative, who will inspect all of your rotors for corrosion or damage. The representative will recommend repair or replacement of at-

risk rotors to prevent potential rotor failures. Contact your local Beckman Coulter office to request this service.

It is your responsibility to decontaminate the rotors and accessories before requesting service by Beckman Coulter Field Service.

	Safety Notice, iii
	Scope, xiii
CHAPTER 1:	Rotors, 1-1
	Introduction, 1-1
	General Description, 1-1
	Rotor Designations, 1-1
	Material, 1-2
	Rotor Retention, 1-3
	Rotor Selection, 1-3
	Pelleting (Differential Separation), 1-9
	Isopycnic Separations, 1-12
	Rate Zonal Separations, 1-12
	General Operating Information, 1-13
	Rotor Balance, 1-13
	Overspeed Protection, 1-14
	Allowable Run Speeds, 1-15
CHAPTER 2:	Tubes and Accessories, 2-1
	Introduction, 2-1
	Labware Selection Criteria, 2-1
	Labware Material Compatibility with Solvents and Sample, 2-3
	Gradient Formation and Fractionation, 2-3
	Labware Types, 2-3
	Polypropylene Tubes, 2-3
	Open-Top Polypropylene Tubes, 2-4
	OptiSeal Tubes, 2-4
	Quick-Seal Tubes, 2-4
	Polycarbonate Tubes, 2-5
	Polypropylene Tubes, 2-5
	Polyethylene Tubes, 2-5
	Ultra-Clear Tubes, 2-5
	Cellulose Propionate Tubes, 2-6
	Conical Tubes, 2-6

Temperature Limits, 2-6
 Spacer and Floating Spacers, 2-6
 Adapters, 2-7

CHAPTER 3: Using Tubes and Accessories, 3-1

Introduction, 3-1
 Gradient Preparation, 3-1
 Cesium Chloride Gradients, 3-2
 General Filling and Sealing or Capping Requirements, 3-2
 Filling and Plugging OptiSeal Tubes, 3-4
 Filling the Tubes, 3-4
 Sealing the Tube Plugs, 3-5
 Filling and Sealing Quick-Seal Tubes, 3-6
 Method A — With the Seal Guide, 3-9
 Method B — Without the Seal Guide, 3-10
 Filling Open-Top Tubes, 3-11
 Open-Top Polypropylene Tubes, 3-11
 Swinging-Bucket Rotors, 3-11
 Fixed-Angle Rotors, 3-11
 Other Open-Top Tubes, 3-11
 Polycarbonate, 3-11
 Ultra-Clear, 3-11
 Polypropylene, 3-11
 Polyethylene, 3-12
 Sample Recovery, 3-12
 Open-Top Tubes, 3-12
 OptiSeal Tubes, 3-12
 Removing Plugs from Tubes, 3-15
 Quick-Seal Tubes, 3-16
 Making Ultra-Clear Tubes Wettable, 3-17

CHAPTER 4: Using Rotors, 4-1

Introduction, 4-1
 Fixed-Angle Rotors, 4-1
 Description, 4-1
 Tubes, 4-2
 Rotor Preparation and Loading, 4-2
 Prerun Safety Checks, 4-2
 Rotor Preparation and Loading, 4-3
 Operation, 4-4
 Installing the Rotor, 4-4
 Removal and Sample Recovery, 4-5
 Swinging-Bucket Rotors, 4-6

	Description, 4-6
	Tubes, 4-7
	Rotor Preparation and Loading, 4-7
	Prerun Safety Checks, 4-7
	Rotor Preparation and Loading, 4-7
	Operation, 4-9
	Installing the Rotor, 4-9
	Removal and Sample Recovery, 4-10
	Vertical-Tube and Near-Vertical Tube Rotors, 4-11
	Vertical-Tube Rotors Description, 4-11
	Near-Vertical Tube Rotors Description, 4-12
	Tubes, 4-12
	Rotor Preparation and Loading, 4-13
	Prerun Safety Checks, 4-13
	Rotor Preparation and Loading, 4-13
	Operation, 4-16
	Installing the Rotor, 4-16
	Removal and Sample Recovery, 4-17
CHAPTER 5:	Care and Maintenance, 5-1
	Introduction, 5-1
	Rotor Care, 5-1
	Cleaning, 5-1
	Decontamination, 5-3
	Sterilization and Disinfection, 5-3
	Inspection, 5-3
	Field Rotor Inspection Program, 5-5
	Lubrication, 5-5
	Tube and Accessory Care, 5-5
	Cleaning, 5-5
	Decontamination, 5-6
	Sterilization and Disinfection, 5-6
	Inspection, 5-7
	Tube and Bottle Storage, 5-8
	Removing Jammed or Collapsed Tubes, 5-8
	Returning a Rotor or Accessory to the Factory, 5-8
	Diagnostic Hints, 5-9
APPENDIX A:	Chemical Resistances for Beckman Coulter Centrifugation Products, A-1
	List of Chemical Resistances, A-1
APPENDIX B:	The Use of Cesium Chloride Curves, B-1
	Introduction, B-1
	Typical Examples for Determining CsCl Run Parameters, B-2

APPENDIX C: Gradient Materials, C-1

Introduction, C-1

APPENDIX D: References, D-1

List of References, D-1

Glossary

Ultracentrifuge Rotor Warranty

Illustrations

- 1.1 Fixed-Angle, Swinging-Bucket, Vertical-Tube, and Near-Vertical Tube Rotors, 1-2
- 1.2 Plunger Mechanism in Locked and Released Positions, 1-3
- 1.3 Particle Separation in Fixed-Angle, Swinging-Bucket, Vertical-Tube, and Near-Vertical Tube Rotors., 1-5
- 1.4 Sedimentation Coefficients (in Svedberg Units) for Some Common Biological Materials, 1-11
- 1.5 Arranging Tubes Symmetrically in a Rotor, 1-14
- 3.1 Filling OptiSeal Tubes. Stems are large enough to accept standard pipettes, 3-5
- 3.2 The Cordless Quick-Seal Tube Topper, 3-7
- 4.1 Fixed-Angle Rotor, 4-2
- 4.2 Swinging-Bucket Rotor, 4-6
- 4.3 Vertical-Tube Rotor, 4-12
- 4.4 Near-Vertical Tube Rotor, 4-12
- B.1 Precipitation Curves for the MLN-80 Rotor, B-4
- B.2 CsCl Gradients at Equilibrium for the MLN-80 Rotor, B-5

Tables

1.1	Rotors Used in Beckman Coulter Tabletop Ultracentrifuges, 1-6
2.1	Characteristics and Chemical Resistances of Tube Materials, 2-2
3.1	Filling and Capping Requirements for Tubes, 3-3
3.2	OptiSeal Tubes and Accessories, 3-4
5.1	Tube Sterilization and Disinfection, 5-7
5.2	Troubleshooting Chart, 5-9
C.1	Commonly Used Gradient Materials with Their Solvents, C-2
C.2	Density, Refractive Index, and Concentration Data—Cesium Chloride at 25°C, Molecular Weight = 168.37, C-3
C.3	Density, Refractive Index, and Concentration Data—Sucrose at 20°C, Molecular Weight = 342.3, C-4
C.4	Density Conversion for Cesium and Rubidium Salts at 20°C, C-5

Scope of this Manual

This manual contains general information for properly preparing a rotor for centrifugation in a Beckman Coulter tabletop preparative ultracentrifuge. This manual should be used with the individual rotor instruction manual shipped with each rotor. The rotor manuals provide specific information for each rotor, including special operating procedures and precautions, tube, bottle, and adapter part numbers, and equations to calculate maximum allowable rotor speeds. Each manual has a code number in the upper right-hand corner of the cover page that can be used for reordering. To reorder, contact customer service at 1-800-742-2345 in the United States; outside the U.S., contact your local Beckman Coulter representative.

A lot of information is compiled in this manual, and we urge you to read it carefully — especially if this is your first experience with Beckman Coulter products.

- [CHAPTER 1](#) describes, by usage, Beckman Coulter's currently produced tabletop preparative ultracentrifuge rotors; this should help you determine the appropriate rotor to use for a particular application. Also included in this section is a discussion of rotor materials, components, and centrifugation techniques.
- [CHAPTER 2](#) describes various tubes, adapters, and spacers to help you choose a particular tube for your application.
- [CHAPTER 3](#) provides instructions for using tubes and related accessories.
- [CHAPTER 4](#) contains step-by-step procedures for preparing each type of rotor for a centrifuge run.
- [CHAPTER 5](#) provides rotor, tube, and accessory care and maintenance information, as well as some diagnostic hints. Please read it. Proper rotor care results in longer rotor life.
- Several appendixes contain information that may be of special interest:
 - [APPENDIX A](#) lists chemical resistances for rotor and accessory materials to help determine compatibility with a variety of solutions.
 - [APPENDIX B](#) describes the use of cesium chloride curves.
 - [APPENDIX C](#) contains reference information on some commonly used gradient materials.
 - [APPENDIX D](#) lists references for further reading.
 - [Glossary](#) provides a glossary of terms.

Introduction

This section is an introduction to the Beckman Coulter family of tabletop preparative ultracentrifuge rotors, providing general information on rotor design, selection, and operation. Rotor designs described are fixed angle, swinging bucket, vertical tube, and near vertical tube type. Specific instructions for using each type of rotor are contained in [CHAPTER 4](#). Care and maintenance information for all of these rotors is contained in [CHAPTER 5](#).

General Description

Rotor Designations

Beckman Coulter tabletop preparative rotors are named according to the type of rotor and the rotor's maximum allowable revolutions per minute (in thousands), referred to as rated speed. For example, the TLS-55 is a swinging-bucket rotor with a maximum speed of 55,000 rpm. Decimal units that are sometimes part of the rotor name, as in the TLA-120.2 and the TLA-120.3, make it possible to distinguish between different rotors that have the same maximum allowable speed. An example of each rotor type is shown in [Figure 1.1](#).

Tubes in *fixed-angle rotors* (designated **MLA** or **TLA**) are held at an angle to the axis of rotation in numbered tube cavities. The bodies of some rotors are fluted to eliminate unnecessary weight and minimize stresses.

In *swinging-bucket rotors* (designated **MLS** or **TLS**), containers are held in rotor buckets attached to the rotor body by hinge pins or a crossbar. The buckets swing out to a horizontal position as the rotor accelerates, then seat against the rotor body for support.

In *vertical-tube rotors* (designated **TLV**), tubes are held parallel to the axis of rotation. These rotors (and the near-vertical tube rotors) have plugs, screwed into the rotor cavities over sealed tubes, that restrain the tubes in the cavities and provide support for the hydrostatic forces generated by centrifugation.

Figure 1.1 Fixed-Angle, Swinging-Bucket, Vertical-Tube, and Near-Vertical Tube Rotors

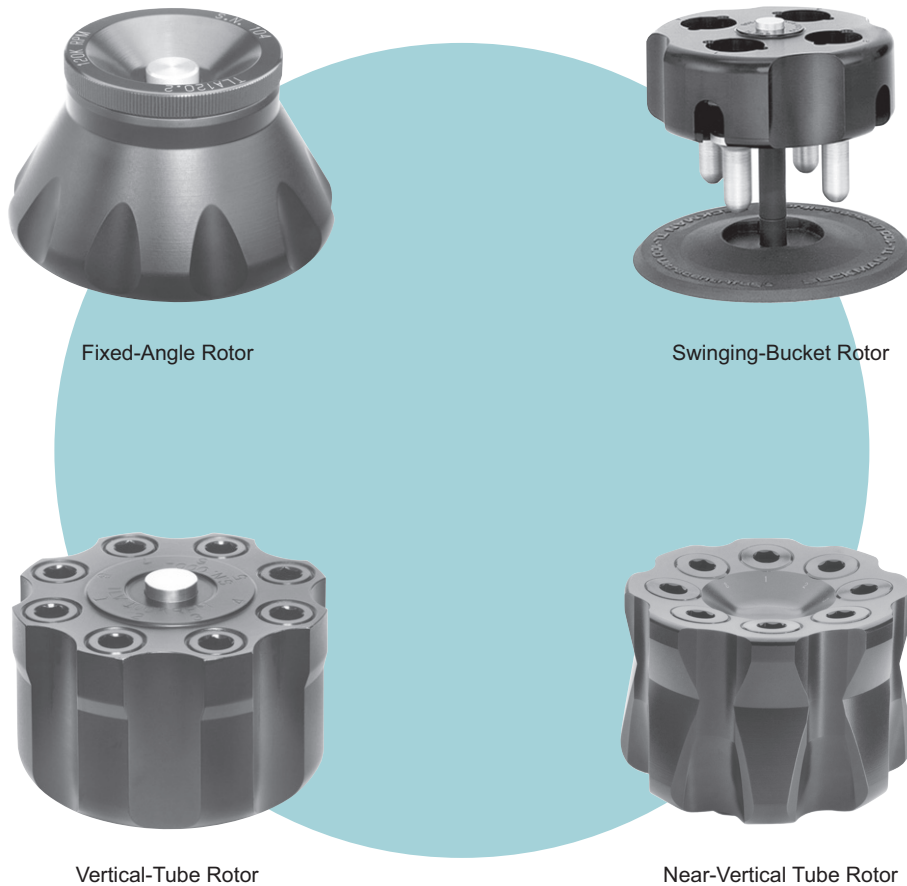

Tubes in *near-vertical tube rotors* (designated **MLN** or **TLN**), are also held at an angle to the axis of rotation in numbered tube cavities. However, the reduced tube angle of these rotors (typically 7 to 10 degrees) reduces run times from fixed-angle rotors (with tube angles of 20 to 45 degrees) while allowing components that do not band under separation conditions to either pellet to the bottom or float to the top of the tube. As in vertical-tube rotors, rotor plugs are used in these rotors to restrain the tubes in the cavities and provide support for the hydrostatic forces generated by centrifugation.

Material

Beckman Coulter rotors are made from either aluminum or titanium. Titanium rotors are stronger and more chemical resistant than the aluminum rotors.

Exterior surfaces of titanium rotors are finished with black polyurethane paint. Aluminum rotors are anodized to protect the metal from corrosion. The anodized coating is a thin, tough layer of aluminum oxide formed electrochemically in the final stages of rotor fabrication. A colored dye may be applied over the oxide for rotor identification.

The O-rings or gaskets in rotor assemblies or lids, and in swinging bucket caps, are usually made of Buna N elastomer and maintain atmospheric pressure in the rotor if they are kept clean and lightly

coated with silicone vacuum grease. Plug gaskets in vertical tube or near vertical tube rotors are made of Hytrel and do not require coating.

Rotor Retention

A rotor retention mechanism on the ultracentrifuge drive hub secures the rotor during the run. A plunger mechanism in the rotor is used to secure a TL series rotor to the drive hub before the run begins (see [Figure 1.2](#)). Engaging the plunger ensures that the rotor does not slip on the hub during initial acceleration and that it remains seated during centrifugation. (The Optima MAX-XP, MAX-TL, MAX, and MAX-E ultracentrifuges automatically secure the rotor to the drive shaft without the need for engaging the plunger.)

Figure 1.2 Plunger Mechanism in Locked and Released Positions*

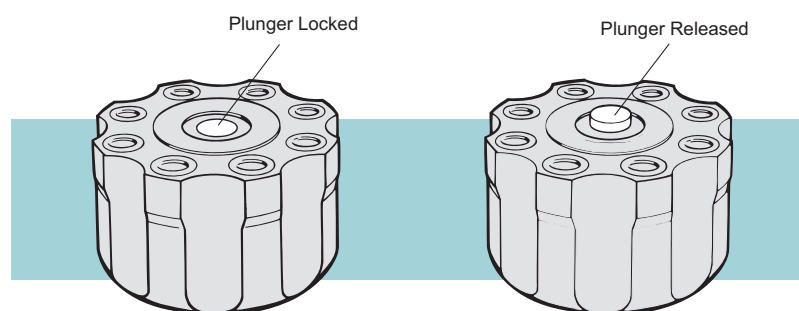

CAUTION

In all tabletop ultracentrifuge models except the Optima MAX-XP, MAX-TL, MAX, and MAX-E, it is very important to lock the rotor in place before beginning the run to ensure that the rotor remains seated during centrifugation. Failure to lock the rotor in place before beginning the run may result in damage to both rotor and instrument.

Rotor Selection

Selection of a rotor depends on a variety of conditions, such as sample volume, number of sample components to be separated, particle size, run time, required quality of separation, type of separation, and the centrifuge in use. Fixed angle, swinging bucket, vertical tube, and near-vertical tube rotors are designed to provide optimal separations for a variety of sample types. Refer to [CHAPTER 4](#) for specific information about the use of each type of rotor.

* Vertical tube rotor shown.

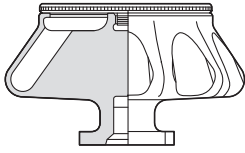

- Fixed-angle rotors are general-purpose rotors that are especially useful for pelleting subcellular particles and in short-column banding of viruses and subcellular organelles. Tubes are held at an angle (usually 20 to 45 degrees) to the axis of rotation in numbered tube cavities. The tube angle shortens the particle pathlength (see [Figure 1.3](#)), compared to swinging-bucket rotors, resulting in reduced run times.

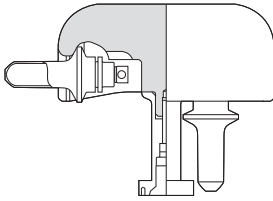

- Swinging-bucket rotors are used for pelleting, isopycnic studies (separation as a function of density), and rate zonal studies (separation as a function of sedimentation coefficient). Swinging-bucket rotors are best applied for rate zonal studies in which maximum resolution of sample zones are needed, or pelleting runs where it is desirable for the pellet to be in the exact center of the tube bottom. Gradients of all shapes and steepness can be used.

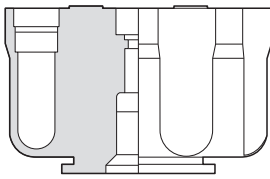

- Vertical-tube rotors hold tubes parallel to the axis of rotation; therefore, bands separate across the diameter of the tube rather than down the length of the tube (see [Figure 1.3](#)). Vertical-tube rotors are useful for isopycnic and, in some cases, rate zonal separations when run time reduction is important. Only Quick-Seal and OptiSeal tubes are used in vertical-tube rotors, making tube caps unnecessary.

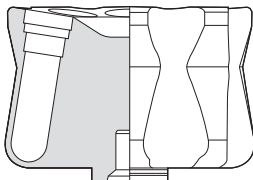

- Near-vertical tube rotors are designed for gradient centrifugation when there are components in a sample mixture that do not participate in the gradient. The reduced tube angle of these rotors significantly reduces run times from the more conventional fixed-angle rotors, while allowing components that do not band under separation conditions to either pellet to the bottom or float to the top of the tube. Like the vertical-tube rotors, near-vertical tube rotors use only Quick-Seal and OptiSeal tubes.

[Table 1.1](#) lists Beckman Coulter tabletop preparative rotors.

Figure 1.3 Particle Separation in Fixed-Angle, Swinging-Bucket, Vertical-Tube, and Near-Vertical Tube Rotors.*

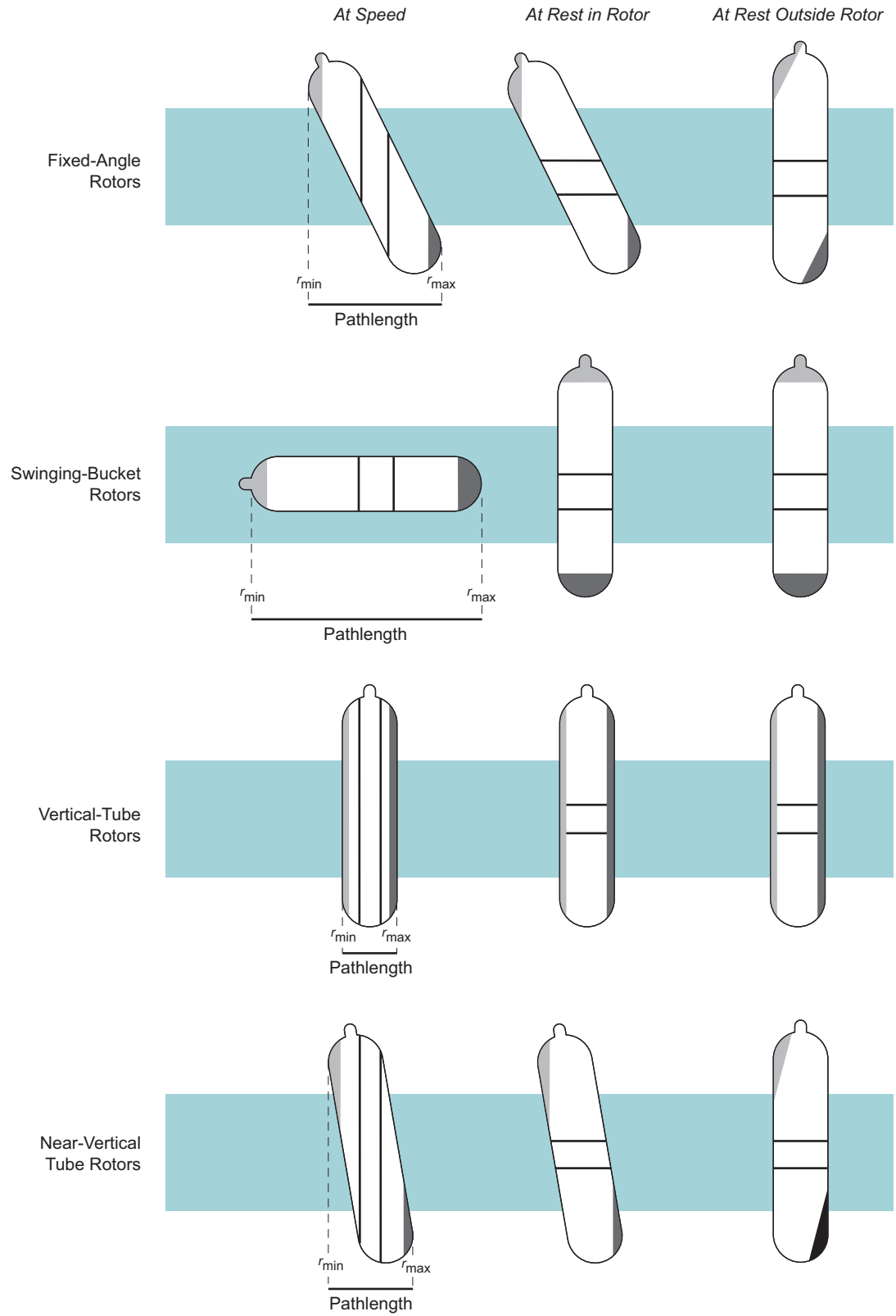

* Dark gray represents pelleted material, light gray is floating components, and bands are indicated by black lines.

Table 1.1 Rotors Used in Beckman Coulter Tabletop Ultracentrifuges

Rotor Profile and Description	Max Speed RCF/ <i>k</i> factor ^a	Radial Distances (mm)			Number of Tubes × Nominal Capacity (largest tube)	Rotor Manual Number
		<i>r</i> _{max}	<i>r</i> _{av}	<i>r</i> _{min}		
 MLA-150 ^b Fixed Angle 30° Angle	150,000 1,003,000 × <i>g</i> 10.4	39.9	27.8	15.8	8 × 2.0 mL	393554
 MLA-130 ^c Fixed Angle 28° Angle	130,000 1,019,000 × <i>g</i> 8.7	59.9	41.9	29.9	10 × 2.0 mL	TL-TB-021
 TLN-120 ^d Near-Vertical Tube 8° Angle	120,000 585,000 × <i>g</i> 7	36.3	30.3	24.3	8 × 1.2 mL	TL-TB-017
 TLA-120.2 ^e Fixed Angle 30° Angle	120,000 627,000 × <i>g</i> 16	38.9	31.8	24.5	10 × 2.0 mL	TL-TB-016
 TLA-120.1 Fixed Angle 30° Angle	120,000 627,000 × <i>g</i> 8	38.9	31.8	24.5	14 × 0.5 mL	TL-TB-015
 TLA-110 ^e Fixed Angle 28° Angle	110,000 657,000 × <i>g</i> 20	48.5	37.2	26.0	8 × 5.1 mL	TL-TB-019
 TLN-100 Near-Vertical Tube 9° Angle	100,000 450,000 × <i>g</i> 14	40.2	31.6	23.1	8 × 3.9 mL	TL-TB-013
 TLA-100.4 ^f Fixed Angle 28° Angle	100,000 543,000 × <i>g</i> 16	48.5	37.2	26.0	8 × 5.1 mL	TL-TB-014

Table 1.1 Rotors Used in Beckman Coulter Tabletop Ultracentrifuges (*Continued*)



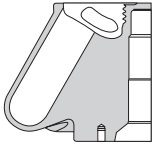
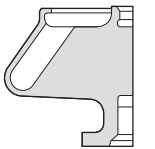
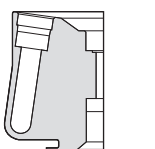
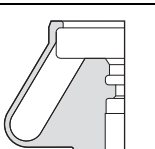
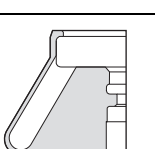
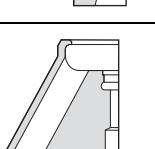
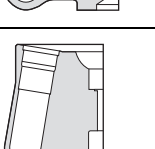
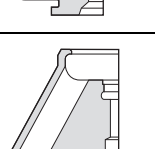

Rotor Profile and Description		Max Speed RCF/ <i>k</i> factor ^a	Radial Distances (mm)			Number of Tubes × Nominal Capacity (largest tube)	Rotor Manual Number
			<i>r</i> _{max}	<i>r</i> _{av}	<i>r</i> _{min}		
	TLA-100.3 Fixed Angle 30° Angle	100,000 541,000 × <i>g</i> 14	48.3	37.9	27.5	6 × 3.5 mL	TL-TB-011
	TLA-100.2 Fixed Angle 30° Angle	100,000 436,000 × <i>g</i> 12	38.9	31.8	24.5	10 × 2.0 mL	TL-TB-005
	TLA-100.1 ^f Fixed Angle 30° Angle	100,000 436,000 × <i>g</i> 12	38.9	31.8	24.5	12 × 0.5 mL	TL-TB-004
	TLA-100 Fixed Angle 30° Angle	100,000 436,000 × <i>g</i> 7	38.9	34.5	30.0	20 × 0.2 mL	TL-TB-003
	TLV-100 Vertical Tube 0° Angle	100,000 400,000 × <i>g</i> 9	35.7	30.2	24.6	8 × 2.0 mL	TL-TB-007
	MLN-80 ^c Near - Vertical Tube 9° Angle	80,000 390,000 × <i>g</i> 20	54.2	43.3	32.5	8 × 8.0 mL	TL-TB-022
	MLA-80 ^c Fixed Angle 26° Angle	80,000 444,000 × <i>g</i> 29	61.9	45.7	29.5	8 × 8.0 mL	TL-TB-024
	MLA-55 ^c Fixed Angle 35° Angle	55,000 287,000 × <i>g</i> 53	84.6	64.0	44.6	8 × 13.5 mL	TL-TB-026

Table 1.1 Rotors Used in Beckman Coulter Tabletop Ultracentrifuges (Continued)

Rotor Profile and Description		Max Speed RCF/ k factor ^a	Radial Distances (mm)			Number of Tubes × Nominal Capacity (largest tube)	Rotor Manual Number
			<i>r</i> _{max}	<i>r</i> _{av}	<i>r</i> _{min}		
	TLA-55 ^e Fixed Angle 45° Angle	55,000 186,000 × <i>g</i> 66	55.0	48.0	25.0	12 × 1.5 mL	TL-TB-020
	TLS-55 ^e Swinging Bucket 90° Angle ^g	55,000 259 000 × <i>g</i> 50	76.5	59.4	42.2	4 × 2.2 mL	TL-TB-006
	MLS-50 ^c Swinging Bucket 90° Angle ^g	50,000 268,000 × <i>g</i> 71	95.8	71.1	47.5	4 × 5 mL	TL-TB-023
	MLA-50 Fixed Angle 30° Angle	50,000 233,000 × <i>g</i> 92	83.2	58.4	33.6	6 × 32.4 mL	B03896
	TLA-45 ^f Fixed Angle 45° Angle	45,000 125,000 × <i>g</i> 99	55.0	48.0	25.0	12 × 1.5 mL	TL-TB-012

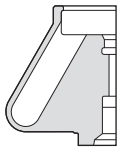
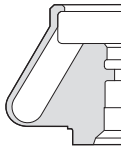
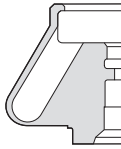
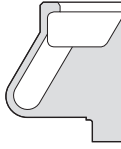
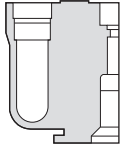
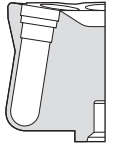
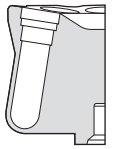
- a. Maximum speeds are based on a solution density of 1.7 g/mL for all rotors except the MLA-80; solution density for the MLA-80 is 1.2 g/mL. The k factors are calculated for all Beckman Coulter rotors (using the largest-volume tube) as a measure of the rotor's relative pelleting efficiency, in water, at 20°C. Relative Centrifugal Field (RCF) is the ratio of the centrifugal acceleration at a specified radius and speed ($\omega^2 r$) to the standard acceleration of gravity (*g*) according to the following formula: $RCF = \omega^2 r / g$, where *r* is the radius in millimeters, ω is the angular velocity in radians per second ($2\pi \text{ RPM} / 60$), and *g* is the standard acceleration of gravity (9807 mm/s²). After substitution: $RCF = 1.12 r (\text{RPM}/1000)^2$.
- b. Use only in the Optima MAX-XP ultracentrifuge.
- c. Use only in Optima MAX, MAX-XP, or MAX-E ultracentrifuges.
- d. Before these rotors can be used in a TL-100 ultracentrifuge the instrument must be updated with a new drive spindle and updated operating software (modification kit number 360477). Operation of these rotors in an unmodified TL-100 may cause the rotor to stick or slip on the spindle.
- e. This rotor was tested to demonstrate containment of microbiological aerosols under normal operating conditions of the associated Beckman Coulter centrifuge, when used and maintained as instructed. Validation of microbiological containment was done at an independent third-party testing facility (CAMR, Porton Down, UK, or USAMRIID, Ft. Detrick, MD, U.S.A.). Improper use or maintenance may affect seal integrity and thus containment.
- f. No longer manufactured.
- g. At speed.

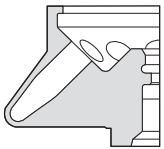
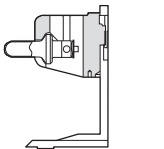
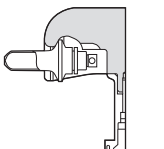
Pelleting (Differential Separation)

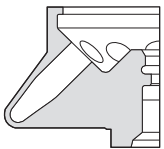
Pelleting separates particles of different sedimentation coefficients, the largest particles in the sample traveling to the bottom of the tube first. Differential centrifugation is the successive pelleting of particles of decreasing sedimentation velocities, using increasingly higher forces and/or long run times. The relative pelleting efficiency of each rotor is measured by its k factor (clearing factor):

EQ 1

$$k = \frac{\ln(r_{\max}/r_{\min})}{\omega^2} \times \frac{10^{13}}{3600}$$

where ω is the angular velocity of the rotor in radians per second ($2\pi\text{RPM}/60$, or $\omega = 0.10472 \times \text{rpm}$), r_{\max} is the maximum radius, and r_{\min} is the minimum radius.

After substitution,

EQ 2

$$k = \frac{(2.533 \times 10^{11}) \ln(r_{\max}/r_{\min})}{\text{rpm}^2}$$

This factor can be used in the following equation to estimate the time t (in hours) required for pelleting:

EQ 3

$$t = \frac{k}{s}$$

where s is the sedimentation coefficient* of the particle of interest in Svedberg units. (Because s values in seconds are such small numbers, they are generally expressed in Svedberg units (S), where 1 S is equal to 10^{-13} seconds). It is usual practice to use the standard sedimentation coefficient $s_{20,\omega}$

* $s = dr/dt \cdot 1/w2r$, where dr/dt is the sedimentation velocity.

based on sedimentation in water at 20°C. Clearing factors can be calculated at speeds other than maximum rated speed by use of the following formula:

EQ 4

$$k_{\text{adj}} = k \left(\frac{\text{rated speed of rotor}}{\text{actual run speed}} \right)^2$$

Run times can also be calculated from data established in prior experiments when the k factor of the previous rotor is known. For any two rotors, a and b:

EQ 5

$$\frac{t_a}{t_b} = \frac{k_a}{k_b}$$

where the k factors have been adjusted for the actual run speed used.

[Figure 1.4](#) lists sedimentation coefficients for some common biological materials. The k factors at maximum speeds for Beckman Coulter preparative rotors are provided in [Table 1.1](#).

Figure 1.4 Sedimentation Coefficients (in Svedberg Units) for Some Common Biological Materials

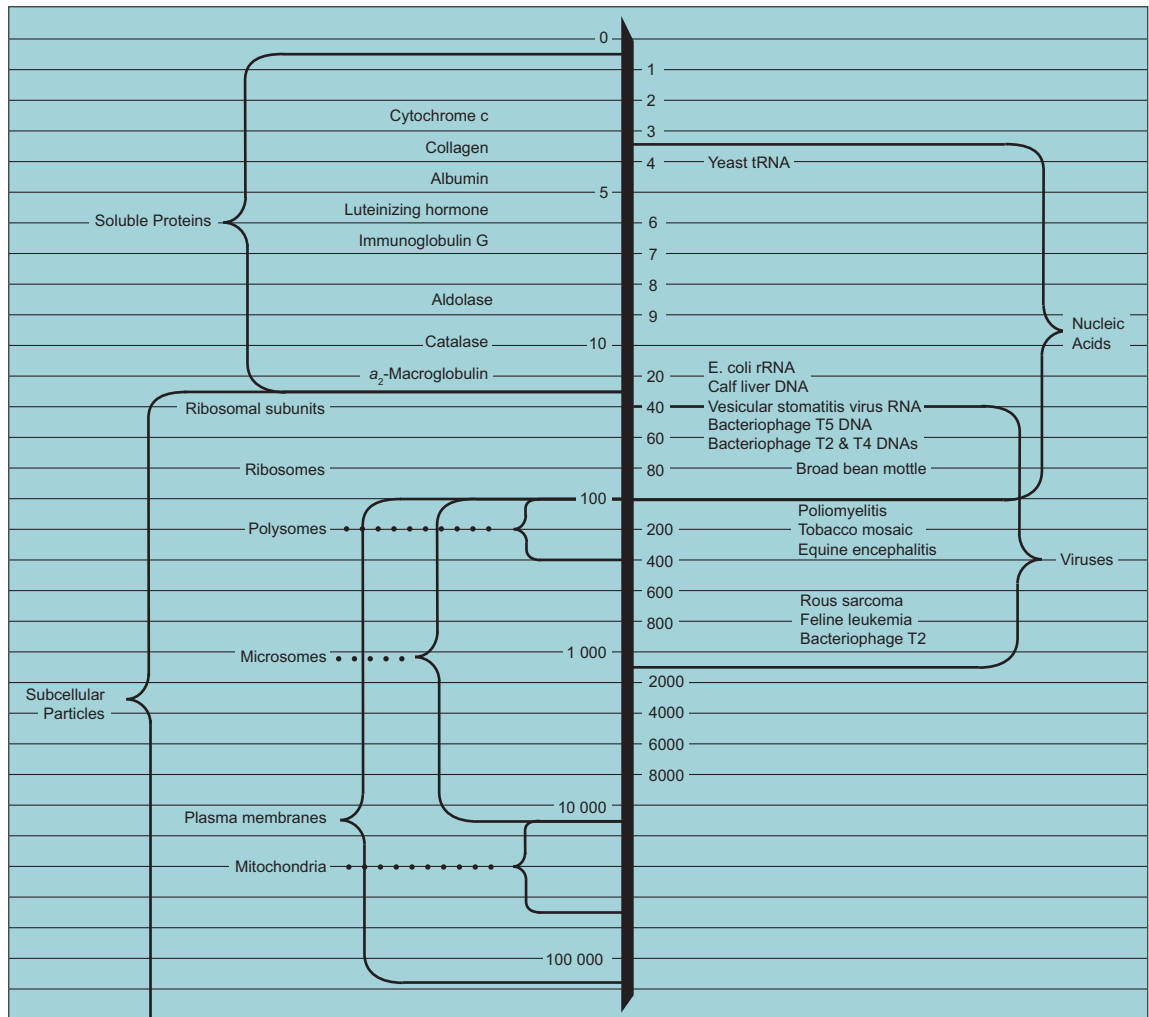

Run times can be shortened in some rotors by using the *g*-Max system. The short pathlength means less distance for particles to travel in the portion of the tube experiencing greatest centrifugal force, and hence shortened run times. Run times can also be shortened in some rotors by using partially filled thickwall polypropylene and polycarbonate tubes. The *k* factors for half-filled tubes can be calculated by using an approximate r_{max} and r_{av} in *k*-factor equation (1).

Isopycnic Separations

A sedimentation-equilibrium, or isopycnic, method separates particles on the basis of particle buoyant density. Each component in the sample travels through the gradient until it reaches an equilibrium position. Particle velocity due to differences in density is given in the following expression:

EQ 6

$$v = \left[\frac{d^2(\rho_p - \rho_c)}{18\mu} \right] \times g$$

where

v= sedimentation velocity (dr/dt)

d= particle diameter

ρ_p = particle density

ρ_c = solution density

μ = viscosity of liquid media

g= standard acceleration of gravity

At equilibrium, $\rho_p - \rho_c$ is zero, and particle velocity is therefore zero.

The gradient may be preformed before the run or generated during centrifugation. For gradients formed by centrifugation, the time it takes to form a gradient depends on the sedimentation and diffusion coefficients of the gradient material, the pathlength, and the rotor speed. For a given gradient material, the shorter the pathlength and the higher the rotor speed, the faster the gradient will form. In general, the time required for gradients to reach equilibrium in swinging-bucket rotors will be longer than in fixed-angle rotors. One way to reduce run times is to use partially filled tubes. Refer to the appropriate rotor instruction manual to determine the maximum allowable speed and solution density when using partially filled tubes.

Rate Zonal Separations

Particle separation achieved with rate zonal separation is a function of the particles' sedimentation coefficient (density, size, and shape) and viscosity of the gradient material. Sucrose is especially useful as a gradient material for rate zonal separation because its physical characteristics are well known and it is readily available. Samples are layered on top of the gradient. Under centrifugal force, particles migrate as zones. Rate zonal separation is time dependent; if the particles are more dense than the most dense portion of the gradient, some or all of the particles will pellet unless the run is stopped at the appropriate time.

A separation is sometimes a combination of rate zonal and isopycnic. Depending on particle buoyant densities and sedimentation coefficients, some particles may be separated by their differential rates of sedimentation, while others may reach their isopycnic point in the gradient.

Clearing factors of swinging-bucket rotors at maximum speeds and various particle densities have been calculated for 5 to 20% (wt/wt) linear sucrose gradients at 5°C. These are called $k\phi$ factor, and are given in the applicable rotor manuals. These constants can be used to estimate the time,

t (in hours), required to move a zone of particles of known sedimentation coefficient and density to the bottom of a 5 to 20% gradient:

EQ 7

$$t = \frac{k'}{s}$$

where s is the sedimentation coefficient in Svedberg units, S . A more accurate way to estimate run times in rate zonal studies is to use the ω^2t charts, available in Use of the ω^2t Integrator (publication DS-528). If the values of s and ω^2 are known, and gradients are either 5 to 20% or 10 to 30% (wt/wt) sucrose, you can use the charts to calculate the run time, t . Conversely, if the value of ω^2t is known, sedimentation coefficients can be estimated from zone positions.

In most cases, when banding two or three components by rate zonal separation, run times can be considerably reduced by using reduced fill levels. Tubes are partially filled with gradient, but the sample volume is not changed (however, gradient capacity will be reduced). Thickwall tubes should be used when this technique is employed, since thinwall tubes will collapse if not full.

If swinging-bucket rotors are used with preformed shallow gradients (<5 to 20%), or if fixed angle, vertical tube, or near-vertical tube rotors are used with any preformed gradient, use the slow acceleration control on your ultracentrifuge. Slow acceleration will protect the sample-to-gradient interface, and slow deceleration will maintain the integrity of the separation during the reorientation process.

General Operating Information

Careful centrifugation technique is essential, because forces generated in ultracentrifugation can be enormous. For example, 1 gram at the bottom of an TLA-100.3 rotor, rotating at 100,000 rpm, exerts the gravitational equivalent of over 0.5 ton of centrifugal mass at the bottom of the tube cavity.

Some of the newer rotors (see [Table 1.1](#)) can be used in the TL-100 ultracentrifuge (no longer manufactured) only if the ultracentrifuge is updated with a new drive spindle and updated operating software (modification kit number 360477). Operation of these rotors in an unmodified TL-100 may cause the rotor to stick or slip on the spindle.

NOTE Specific information about filling, sealing, and capping containers, loading rotors, etc., can be found in later sections.

Rotor Balance

The mass of a properly loaded rotor will be evenly distributed on the ultracentrifuge drive hub, causing the rotor to turn smoothly with the drive. An improperly loaded rotor will be unbalanced; consistent running of unbalanced rotors will reduce ultracentrifuge drive life. To balance the rotor load, fill all opposing tubes to the same level with liquid of the same density. Weight of opposing

tubes must be distributed equally. Place tubes in the rotor symmetrically, as illustrated in Figure 1.5.

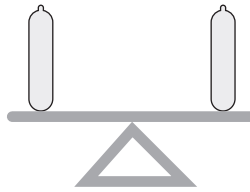

CAUTION

For swinging bucket rotors, attach ALL buckets, whether loaded or empty. For vertical tube and near vertical tube rotors, insert spacers and rotor plugs ONLY in holes containing loaded tubes.

Figure 1.5 Arranging Tubes Symmetrically in a Rotor*

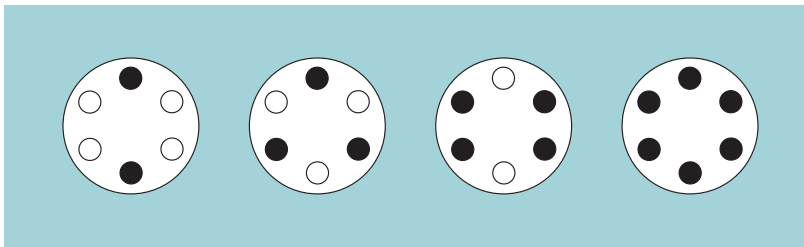

If sample quantity is limited and the rotor is not balanced, do one of the following to balance the rotor, depending on the rotor in use:

- Load the opposite rotor cavities or buckets with tubes containing a liquid of the same density as opposing tubes.
- Use smaller tubes with adapters or smaller Quick-Seal tubes with floating spacers to distribute the sample symmetrically.
- Use thickwall tubes partially filled to distribute sample to additional tubes.
- Layer a low-density, immiscible liquid, such as mineral oil, on top of the sample to fill opposing tubes to the same level. (Do not use an oil overlay in Ultra-Clear tubes.)

Overspeed Protection

Rotors are specifically designed to withstand a maximum load (that is, volume and density of the rotor contents) at maximum rated speed. At greater speeds, or at rated speeds with heavier loads, rotors are subject to failure. It is the operator's responsibility to limit rotor speed when centrifuging dense solutions or when using heavy tubes; refer to *Allowable Run Speeds*, below.

The ultracentrifuge identifies rotor speed during the run by means of a magnetic speed sensor system in the rotor chamber of the instrument and magnets on the bottom of the rotor. The overspeed system ensures that the rotor does not exceed its permitted speed.

* For example, two, three, four, or six tubes can be arranged symmetrically in a six-place rotor.

Allowable Run Speeds

Under some conditions, the maximum allowable speed of the rotor (indicated by the rotor name) must be reduced to ensure that neither the rotor nor the labware are overstressed during centrifugation. Check the recommended run speed for your rotor before centrifuging dense solutions, CsCl gradients, uncapped plastic tubes in fixed-angle rotors, and sleeve-type adapters.

- *Dense Solutions.* To protect the rotor from excessive stresses due to the added load, reduce run speed when centrifuging a solution with a density greater than the allowable density rating of the rotor (specified in the rotor instruction manual). When using dense solutions in plastic labware, determine maximum run speed using the following square-root reduction formula:

EQ 8

$$\text{reduced run speed} = \text{maximum rated speed} \sqrt{\frac{A}{B}}$$

- where A is the maximum permissible density of the tube contents for a particular rotor (from the rotor instruction manual), and B is the actual density of the tube contents to be centrifuged.
- *Cesium Chloride Gradients.* Run speed often must be reduced to avoid the precipitation of CsCl during centrifugation of concentrated CsCl solutions. Use the CsCl curves provided in the individual rotor instruction manual to determine run speeds. An example of the use of CsCl curves is in [APPENDIX B](#) of this manual.
- *Uncapped Thickwall Plastic Tubes in Fixed-Angle Rotors.* Speed limitations are required to prevent tube collapse when thickwall plastic tubes are centrifuged without the support of tube caps in fixed-angle rotors.
- *Adapters.* When small tubes are used with Delrin adapters, run speed often must be reduced due to the increased density of Delrin (1.4 g/mL). Consult individual rotor manuals for allowable run speeds.

Tubes and Accessories

Introduction

This section describes various labware used in Beckman Coulter ML and TL series rotors. General instructions for using containers follow in [CHAPTER 3](#). Care and maintenance instructions are in [CHAPTER 5](#). General rotor use instructions are in [CHAPTER 4](#). The individual rotor manual that comes with each rotor provides specific instructions on the tubes and accessories that can be used in a particular rotor. A table of chemical resistances can be found in [APPENDIX A](#) of this manual.*

Labware Selection Criteria

No single tube design or material meets all application requirements. Labware choice is usually based on a number of factors.

- The centrifugation technique to be used, including the rotor in use, volume of sample to be centrifuged, need for sterilization, importance of band visibility, and so forth
- Chemical resistance—the nature of the sample and any solvent or gradient media
- Temperature and speed considerations
- Whether tubes are to be reused

[Table 2.1](#) contains an overview of some of the characteristics of tube materials.

NOTE This information has been consolidated from a number of sources and is provided *only* as a guide to the selection of tube or bottle materials. Soak tests at 1 *g* (at 20°C) established the data for most of the materials; reactions may vary under the stress of centrifugation, or with extended contact or temperature variations. To prevent failure and loss of valuable sample, ALWAYS TEST SOLUTIONS UNDER OPERATING CONDITIONS BEFORE USE.

* A complete list of tubes and accessories is provided in the latest edition of the Beckman Coulter Ultracentrifuge Rotors, Tubes & Accessories catalog (BR-8101), available at www.beckmancoulter.com.

Table 2.1 Characteristics and Chemical Resistances of Tube Materials^a

Tube or Bottle Type	Optical Property	Puncturable	Sliceable	Reusable	Acids (dilute or weak)	Acids (strong)	Alcohols (aliphatic)	Aldehydes	Bases	Esters	Hydrocarbons (aliphatic)	Hydrocarbons (aromatic and halogenated)	Ketones	Oxidizing Agents (strong)	Salts
thinwall polypropylene	transparent	yes	yes	no	S	U	U	M	S	U	U	U	U	U	S
thickwall polypropylene	translucent	no	no ^b	yes	S	S	S	M	S	M	M	U	M	U	S
Ultra-Clear	transparent	yes	yes	no	S	U	U	S	U	U	U	U	U	U	M
polycarbonate	transparent	no	no	yes	M	U	U	M	U	U	U	U	U	M	M
polypropylene	translucent/ transparent	no	no	yes	S	S	S	M	S	M	S	M	M	M	S
polyethylene	transparent/ translucent	yes	no	yes	S	S	S	S	S	S	U	M	M	M	S
cellulose propionate	transparent	no	no ^b	no	S	U	U	U	U	M	S	S	U	M	S

S - satisfactory resistance

M = marginal resistance

U = unsatisfactory
resistance

a. Refer to Appendix A for information about specific solutions.

b. Polypropylene and cellulose propionate tubes with diameters of 5 to 13 mm may be sliced using the CentriTube Slicer (part number 347960) and appropriate adapter plate.



Do not use flammable substances in or near operating centrifuges.

Labware Material Compatibility with Solvents and Sample

The chemical compatibility of tube materials with the gradient-forming medium or other chemicals in the solution is an important consideration. Although neutral sucrose and salt solutions cause no problems, alkaline solutions cannot be used in Ultra-Clear or polycarbonate tubes. Polycarbonate and Ultra-Clear tubes are incompatible with DMSO, sometimes used in the preparation of sucrose gradients for sedimentation of denatured DNA. Refer to [APPENDIX A](#) for detailed compatibility information.

Gradient Formation and Fractionation

Consideration should be given to gradient formation and fractionation when choosing a tube for a density gradient run. If the bands or zones formed during centrifugation are indistinct, they may not be visible through a translucent material such as polypropylene. If optimum band visualization is important, Ultra-Clear, polycarbonate, or cellulose propionate tubes should be used. Whenever collection of bands or zones must be done by slicing or puncturing the tube, a thin, flexible tube wall is required. Ultra-Clear or polypropylene tubes should be used in these cases, depending on the need for transparency.

Labware Types

NOTE Tubes made of cellulose nitrate were formerly used for various separations, particularly rate-zonal separations. Beckman Coulter discontinued the use of cellulose nitrate for tube manufacture in 1980, due to inconsistent physical properties inherent in the material. If you currently have cellulose nitrate tubes, dispose of them. Consult your laboratory safety officer for proper disposal procedures.

Polypropylene Tubes

Polypropylene tubes are translucent or transparent in appearance, depending on wall thickness, and are non-wettable (although some polypropylene tubes can be chemically treated to make them wettable). Polypropylene tubes are reusable unless deformed during centrifugation or autoclaving. Polypropylene tubes have good tolerance to gradient media, including alkalines. They are satisfactory for many acids, bases, alcohols, DMSO, and some organic solvents. They can be used with or without caps in fixed-angle rotors. Speed reduction is sometimes required with these tubes if run with less than full volume (refer to your rotor manual). Several types of polypropylene tubes are available.

Open-Top Polypropylene Tubes



Thinwall open-top tubes are used in swinging bucket and fixed-angle rotors. In swinging-bucket rotors, thinwall tubes should be filled to within 2 or 3 mm of the tube top for proper tube support. Caps are usually required in fixed-angle rotors. Thinwall tubes are designed for one-time use and should be discarded after use.



Thickwall open-top tubes offer the convenience of centrifuging partially filled tubes without tube caps in fixed-angle and swinging-bucket rotors. Because the solution re-orient during centrifugation, the maximum partial fill volume depends on the tube angle. For greater fill volumes, use tubes with caps. Refer to the applicable rotor manual for fill volumes and speed reduction requirements. Thickwall polypropylene tubes are typically reusable unless deformed during centrifugation or autoclaving.

OptiSeal Tubes

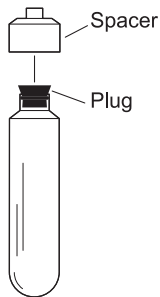

OptiSeal tubes, single-use tubes designed for use in certain rotors, are available in dome-top and bell-top styles. These tubes, which come with plastic sealing plugs, can be quickly and easily prepared for use without tools or heat. Spacers are used to seal the tubes and to support the tops of the tubes during centrifugation. With the tube plug and spacer (and rotor plug, if required) in place, the g forces during centrifugation ensure a tight, reliable seal that protects your samples. For a detailed discussion on the use of OptiSeal tubes, refer to Using OptiSeal Tubes (publication IN-189), included with each box of tubes.

Quick-Seal Tubes

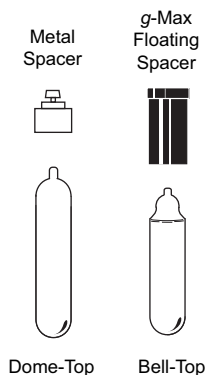

Heat-sealed Quick-Seal tubes are used in swinging bucket, vertical tube, near vertical tube, and in most fixed angle rotors. Single-use Quick-Seal tubes are a convenient form of sealable tube; they are especially useful for the containment of radioactive or pathogenic samples. There are two Quick-Seal tube designs, dome-top and bell-top.

- The bell-top simplifies removal of materials that float during centrifugation.
- Dome-top tubes hold more volume than their bell-top equivalents.

Detailed information about Quick-Seal tubes is contained in publication IN-181.

Polycarbonate Tubes



Polycarbonate is tough, rigid, nonwetable, and glass-like in appearance. Polycarbonate tubes are used in fixed angle rotors, and at least half full in swinging bucket rotors. Speed reduction may be required in some rotors if the tubes are not completely filled.

Although polycarbonate tubes may be autoclaved, doing so greatly reduces the usable life of these tubes. Cold sterilization methods are recommended. Washing with alkaline detergents can cause failure. Crazing—the appearance of fine cracks in the tube—is the result of stress “relaxation” and can affect tube performance. These cracks will gradually increase in size and depth, becoming more visible. Tubes should be discarded before cracks become large enough for fluid to escape. These tubes have good tolerance to all gradient media except alkalines (pH greater than 8). They are satisfactory for some weak acids, but are unsatisfactory for all bases, alcohol, and other organic solvents.

Polypropylene Tubes

Polypropylene tubes are translucent and are reusable unless deformed during centrifugation or autoclaving. These tubes have good tolerance to gradient media including alkalines. They are satisfactory for many acids, bases, and alcohols, but are marginal to unsatisfactory for most organic solvents. They can be used with or without caps in fixed angle rotors. Speed reduction is sometimes required with these tubes if run with less than full volume (refer to your rotor manual).

Polyethylene Tubes

Polyethylene tubes are translucent or transparent and have a good tolerance for use with strong acids and bases. They are reusable but cannot be autoclaved. In swinging bucket rotors, they are used without caps, and with or without caps in fixed angle rotors.

Ultra-Clear Tubes

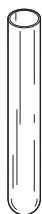

Ultra-Clear tubes, made of a tough thermoplastic, are thinwall and not wettable (but can be made wettable; see [CHAPTER 3](#)). Ultra-Clear tubes are available in two types—open-top and Quick-Seal. They are transparent centrifuge tubes, offering easy location of visible banded samples. Standard straight-wall Ultra-Clear tubes must be filled completely and capped for use in fixed angle rotors.

Ultra-Clear tubes are designed to be used one time only. These tubes have good resistance to most weak acids and some weak bases, but are unsatisfactory for DMSO and most organic solvents, including all alcohols. Ultra-Clear tubes should not be autoclaved.

Cellulose Propionate Tubes

Cellulose propionate tubes, used in some fixed angle rotors, are transparent and designed for one-time use. They are used without caps and should be full for centrifuging. They should not be autoclaved or sterilized with alcohol. These tubes have good tolerance to all gradient media including alkalines. They are unsatisfactory for most acids and alcohols.

Konical Tubes

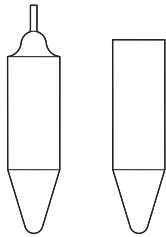

Cellulose propionate tubes, used in some fixed angle rotors, are transparent and designed for one-time use. They are used without caps and should be full for centrifuging. They should not be autoclaved or sterilized with alcohol. These tubes have good tolerance to all gradient media including alkalines. They are unsatisfactory for most acids and alcohols.

Temperature Limits

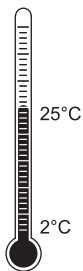

Each labware material has a specified temperature range. Although some ultracentrifuges can achieve temperatures as high as 45°C, only certain tube or bottle materials can be run under these conditions. Most containers are made of thermoplastic materials that soften at elevated temperatures. This temperature-induced softening, together with such factors as the centrifugal force, the run duration, the type of rotor, previous run history, and the tube angle, can cause labware to collapse. Therefore, if high-temperature runs—above 25°C—are required, it is best to pretest labware under the actual experimental conditions, using buffer or gradient of similar density rather than a valuable sample.

- Plastic labware has been centrifuge tested for use at temperatures between 2 and 25°C. For centrifugation at other temperatures, pretest tubes under anticipated run conditions.
- If plastic containers are frozen before use, make sure that they are thawed to at least 2°C prior to centrifugation.

Spacer and Floating Spacers

- OptiSeal tubes must be used with the appropriate spacer to seal properly. (OptiSeal spacers are listed in [Table 3.2](#).)
- Quick-Seal tubes use a spacer, one or more floating spacers, or a combination of both (depending on the size of the tube) to support the top of the tube during centrifugation. The particular combination depends on the type of rotor being used. In swinging bucket and fixed

angle rotors, the top of the tube must be supported. In near vertical tube and vertical tube rotors, the entire tube cavity must be filled.

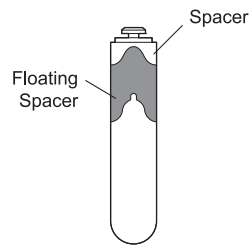

The g-Max system uses a combination of short bell-top Quick-Seal tubes and floating spacers (also referred to as g-Max spacers). The floating spacers sit on top of the Quick-Seal tubes so there is no reduction of maximum radial distance, and therefore, no reduction of g force. The shorter pathlength of the tubes also permits shorter run times. For more information on the g-Max system, see publication DS-709.

Plastic spacers have been tested for centrifugation between 2 and 25°C. If spacers are centrifuged at temperatures significantly greater than 25°C, deformation of the spacer and tube may occur.

Adapters*

Many rotors can accommodate a variety of tube sizes by using adapters that line the tube cavity or bucket.

- Small, open-top tubes use Delrin* adapters, which line the tube cavity or bucket.
- Adapters with conical cavities must be used to support both open-top and Quick-Seal conical tubes.

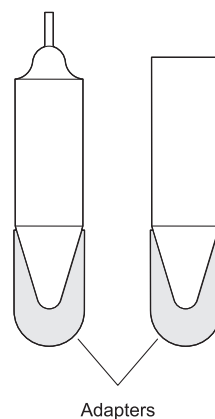

Tubes used with adapters can be filled (and capped) according to the type of tube and the design of the rotor being used. Many of the small, straightwall tubes, when used with adapters, require speed reductions due to the added density of Delrin (1.4 g/mL). Additional speed reductions for heavy tube loads may also be required (refer to [Allowable Run Speeds](#) in [CHAPTER 1](#)).

* Delrin is a registered trademark of E. I. Du Pont de Nemours & Company.

Using Tubes and Accessories

Introduction

*This section contains general instructions for filling and capping the labware used in Beckman Coulter preparative rotors, for selecting and using the appropriate accessories, and for recovering samples after a run. Individual rotor manuals provide specific instructions on tubes and accessories that can be used in a particular rotor.**

Rotor use instructions are in [CHAPTER 4](#). A table of chemical resistances is in [APPENDIX A](#) of this manual. Reference information on some commonly used gradient materials is in [APPENDIX C](#).

Gradient Preparation

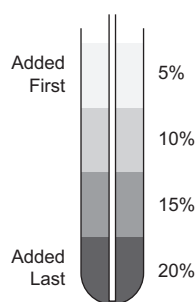

Many commercial gradient formers are available. These devices usually load a tube by allowing the gradient solutions to run down the side of the tube. The heaviest concentration is loaded first, followed by successively lighter concentrations. This method is acceptable for wettable tubes; however, loading a nonwetable tube (such as Ultra-Clear, polypropylene, and polycarbonate) by allowing solutions to run down the side of the tube can cause mixing.

Gradients in nonwetable tubes can be prepared using a gradient former by placing a long syringe needle or tubing to the tube bottom and reversing the gradient chambers. In that way the lightest gradient concentration is loaded first, underlaid by increasingly heavier concentrations.

* A complete list of tubes, bottles, and adapters is provided in the latest edition of the Beckman Coulter Ultracentrifuge Rotors, Tubes & Accessories catalog (BR-8101), available at www.beckmancoulter.com.

Using Tubes and Accessories

General Filling and Sealing or Capping Requirements

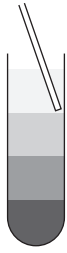

You can also prepare preformed step gradients by hand, using a pipette. Carefully layer solutions of decreasing concentration by placing the tip of the pipette at the angle formed by the tube wall and the meniscus, or float the lighter gradient concentrations up by adding increased density solutions to the tube bottom using a hypodermic syringe with a long needle such as a pipetting needle.

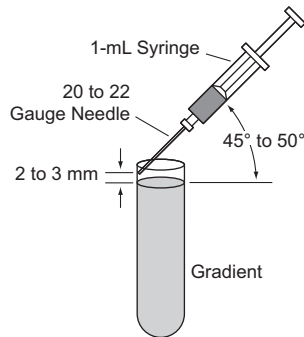

Another way to form a linear gradient is to allow a step gradient to diffuse to linearity. Depending on the concentration differential between steps and the cross-sectional area, allow 3 to 6 hours for diffusion at room temperature, and about 16 hours at 0 to 4°C. For diffusion of step gradient in Quick-Seal and capped straightwall tubes, slowly lay the tube on its side (tube contents will not spill, but make sure the tube does not roll). After 2 hours at room temperature, slowly set the tube upright.

Once the gradient is prepared, layer the sample on top of the gradient.

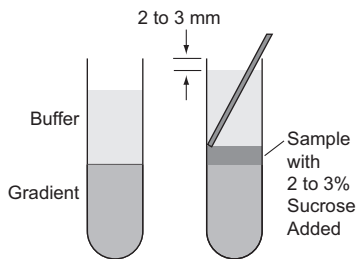

For thinwall tubes only partially filled with gradient, add a buffer solution to fill the tube to provide tube wall support. Although the gradient volume is reduced, sample volume is not changed.

NOTE If a partially filled thickwall tube is centrifuged, the tube does not require liquid support, and therefore, the buffer solution is not required.

Cesium Chloride Gradients

Cesium chloride gradients can be made by filling the tube with a homogeneous solution of CsCl and sample. Select a homogeneous CsCl solution density so that when it is distributed, its density range will encompass the density of the particle(s) of interest. Refer to [APPENDIX B](#) for an explanation of the use of the CsCl curves.

General Filling and Sealing or Capping Requirements

See [Table 3.1](#) for general filling and sealing requirements for tubes used in ML or TL series preparative rotors. Maximum fill volume includes sample and gradient. Refer to individual rotor manuals for specific filling and capping requirements.

WARNING

Handle body fluids with care because they can transmit disease. No known test offers complete assurance that they are free of micro-organisms. Some of the most virulent —Hepatitis (B and C) and HIV (I-V) viruses, atypical mycobacteria, and certain systemic fungi—further emphasize the need for aerosol protection. Handle other infectious samples according to good laboratory procedures and methods to prevent spread of disease. Because spills may generate aerosols, observe proper safety precautions for aerosol containment. Do not run toxic, pathogenic, or radioactive materials in these rotors without taking appropriate safety precautions. Biosafe containment should be used when Risk Group II materials (as identified in the World Health Organization *Laboratory Biosafety Manual*) are handled; materials of a higher group require more than one level of protection.

Table 3.1 Filling and Capping Requirements for Tubes

Tube or Bottle	Swinging-Bucket Rotors	Filling Level Requirements	
		Fixed-Angle Rotors	Vertical- and Near-Vertical Tube Rotors
Polypropylene thinwall tubes	within 2–3 mm of top	full and capped	—
thickwall tubes	at least 1/2 full	1/2 full to max capless level	—
OptiSeal tubes	full and plugged	full and plugged	full and plugged
Quick-Seal tubes	full and heat sealed	full and heat sealed	full and heat sealed
konal Quick-Seal tubes	full and heat sealed	—	—
konal open-top tubes	within 2–3 mm of top	—	—
Ultra-Clear open-top tubes	within 2–3 mm of top	full and capped	—
Quick-Seal tubes	—	full and heat sealed	full and heat sealed
Polycarbonate thickwall tubes	at least 1/2 full	1/2 full to max capless level	—
Cellulose Propionate tubes	full	1/2 full to max capless level; no cap	—
Polypropylene tubes	at least 1/2 full	1/2 full to max capless level	—
Polyethylene tubes	at least 1/2 full	1/2 full to max capless level	—





Filling and Plugging OptiSeal Tubes

OptiSeal tubes are not sealed prior to centrifugation; a Noryl plug, furnished with each tube, is inserted into the stem of filled tubes. When the tubes are loaded into the rotor with tube spacers (and rotor plugs, in vertical-tube and near-vertical tube rotors) in place, the *g*-force during centrifugation ensures a tight, reliable seal that protects your samples. For a detailed discussion on the use of OptiSeal tubes, refer to *Using OptiSeal Tubes* (publication IN-189).

Filling the Tubes

For filling convenience, use the appropriate eight-tube rack listed in [Table 3.2](#).

Table 3.2 OptiSeal Tubes and Accessories^a

Size (mm)	Volume (mL)	Part Number ^b (pkg/56)	Spacer	Rack Assembly	Rotor
13 × 33	3.3	361627 	361698 (pkg/2) gold aluminum 	361650	TLN-100
13 × 48	4.7	361621 Bell-top 	361676 (pkg/2) amber Ultem ^c 	361638	TLA-100.4 TLA-110

- a. Spacers and plugs are shown in the correct orientation for placement onto tubes
b. Disposable plastic plugs included.
c. Ultem is a registered trademark of GE Plastics.

- 1 Use a pipette or syringe to fill each tube, leaving *no* fluid in the stem (see [Figure 3.1](#)).
 - Overfilling the tube can cause overflow when the plug is inserted; however, too much air can cause the tube to deform and disrupt gradients and sample bands, as well as increasing the force required to remove the tube from the cavity after centrifugation.

NOTE If air bubbles occur in the tube shoulder area, tilt and rotate the tube before it is completely filled to wet the tube.

- a. Homogeneous solutions of gradients and sample may be loaded into the tubes and centrifuged immediately.
 - (See [Gradient Preparation](#) above.)
- b. If the sample is to be layered on top, be sure to allow enough room for the sample so that there is *no fluid in the tube stem*.

- 2 After filling the tube, make sure that there is no fluid in the stem.
 - a. (Draw off excess fluid with a syringe or pipette.)
 - b. If necessary, wipe the inside of the stem with a lintless tissue.)
- 3 Fill the remaining tubes in the same manner.

Figure 3.1 Filling OptiSeal Tubes. Stems are large enough to accept standard pipettes

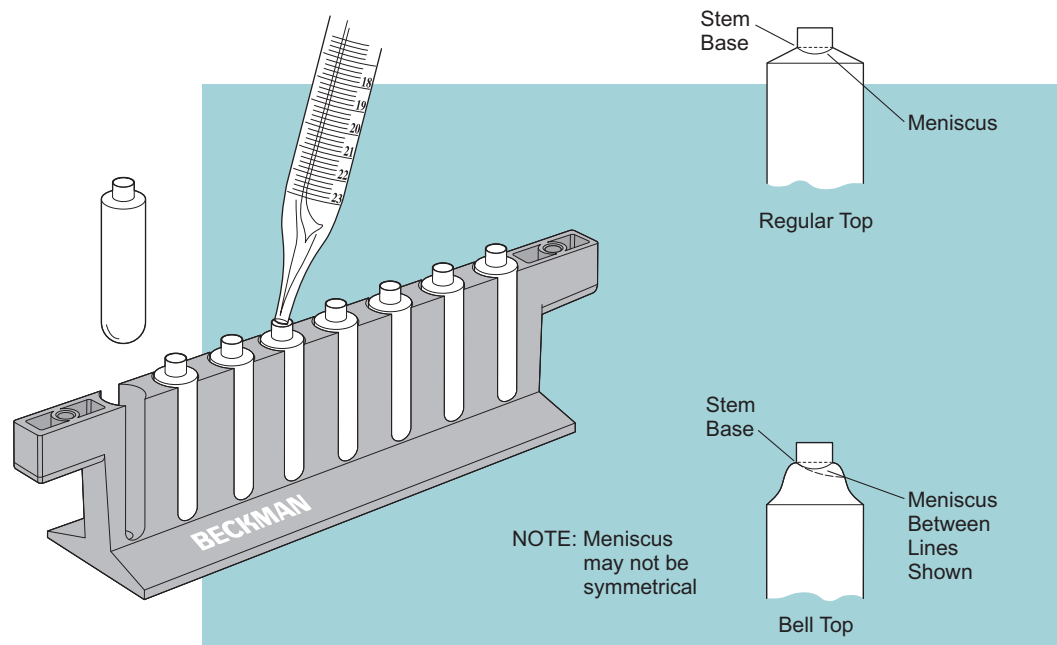

Sealing the Tube Plugs

Eight tubes can be prepared for use at once in the specially designed racks listed in [Table 3.2](#).

- 1 Make sure that no fluid is in the tube stem and that the stem is clean and dry.
- 2 Insert a Noryl plug assembly (plug and O-ring—shipped assembled) in each tube stem.

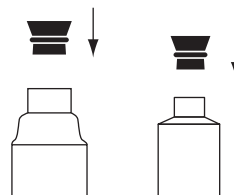

- 3 Set the plug seating bar on the rack, ensuring that the pegs at each end fit into the rack openings.
- 4 Press firmly straight down all along the top of the bar.
 - When you remove the bar, the plugs should be straight and seated into the stems.

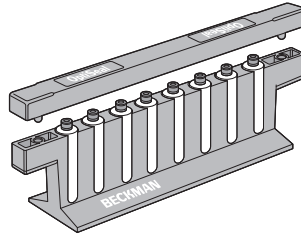

- 5 Check the tubes to be sure all plugs are seated.
 - a. If any plugs are not seated, seat them individually.



Filling and Sealing Quick-Seal Tubes

Fill each tube to the base of the neck, using a syringe with a 13-gauge or smaller needle.* A small air space (no larger than 3 mm) may be left, but an air bubble that is too large can cause the tube to deform, disrupting gradients or sample. Spacer and/or floating spacer requirements for Quick-Seal tubes are described in the individual rotor manuals. The neck of the tube should be clean and dry before sealing.

There are two tube sealers for use with Quick-Seal tubes—the hand-held Cordless Tube Topper, and the older tabletop model (no longer available). Refer to *How to Use Quick-Seal Tubes with the Beckman Cordless Tube Topper* (publication IN-181) for detailed information about the Tube Topper. Instructions for using the older tabletop tube sealer are in *How to Use Quick-Seal Tubes with the Beckman Tube Sealer* (publication IN-163).

* A sample application block (342694) is available for holding and compressing tubes, and can be used to layer samples on preformed gradients in polypropylene Quick-Seal tubes.

Quick-Seal tubes are heat-sealed quickly and easily using the Beckman Cordless Tube Topper (see Figure 3.2). The following procedures provide the two methods for heat-sealing Quick-Seal tubes using the hand-held Tube Topper. Use the applicable tube rack listed in the applicable rotor manual.

CAUTION

Before plugging in the Tube Topper, be sure that you have a proper power source (120 V, 50 or 60 Hz). Charge your Cordless Tube Topper only in the charging stand supplied with it.

Figure 3.2 The Cordless Quick-Seal Tube Topper

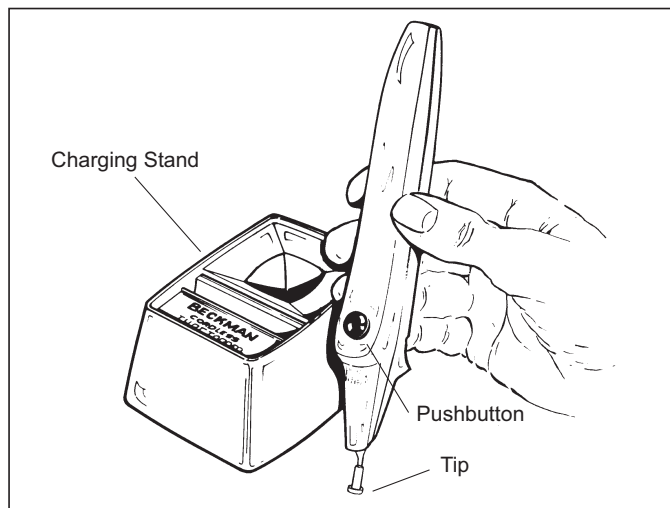

- 1 Remove the Tube Topper from the charging stand.
 - a. Leave the pushbutton turned to LOCK position.
 - b. Insert the ends of the Tube Topper tip into the two openings of the copper strips at the end of the Tube Topper device.

WARNING

Touching the heated tip of the Tube Topper will cause burns. When the pushbutton is pressed, the tip heats almost immediately. Make sure the pushbutton is turned to LOCK position *unless you are actually sealing a tube*.

-
- 2 Place a seal former on each tube stem.
- (The Teflon* coating on the seal formers is permanent.)
- a. Do not scratch the interior of the formers, as you may damage this coating.)

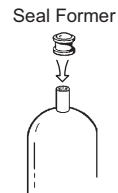

-
- 3 Seal each tube using Method A (With the Seal Guide) or B (Without the Seal Guide).
Method A is preferable when sealing smaller tubes or when resealing a tube that leaks.

CAUTION

Always keep the Tube Topper in its charging stand when not in use. Do not lay the unit against any surface after use until the tip has cooled (3 to 5 minutes after shut off).

* Teflon is a registered trademark of E.I. Du Pont de Nemours & Co.

Method A — With the Seal Guide

Seal Guide



1. Place a seal guide (with the flat side down) over the seal former.
2. Turn the Tube Topper pushbutton to USE position. Press the pushbutton and wait 3 to 5 seconds for the tip to heat.
3. Apply the tip of the Tube Topper vertically to the seal former. Press down gently for about 10 seconds. The seal guide should move down the tube stem until it rests on the tube shoulder. Using the seal guide prevents the seal former from being pressed into the tube shoulder.

NOTE Always apply the tip of the Tube Topper vertically to the seal former. Apply gentle pressure when sealing the tube

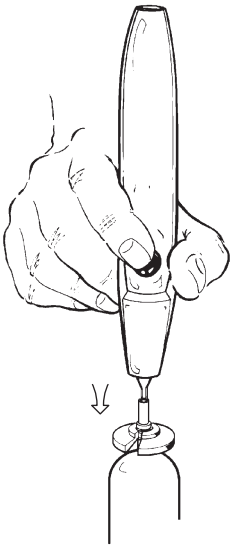

Heat Sink

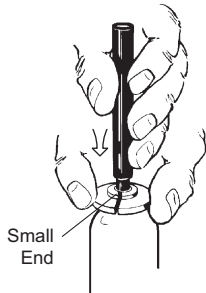

When the seal guide has moved to the correct position, remove the Tube Topper and pinch the circular seal guide to hold the seal former in place.

Place the heat sink (small end) over the cap for 2 to 3 seconds while the plastic cools—do NOT let the seal former pop up. (If the seal former does pop up, the tube may not have an adequate seal and may need to be resealed.)

Remove the heat sink and seal guide. When the seal former cools, remove it by hand or with the removal tool (361668). Save the seal guide and former for future use.

Removal Tool

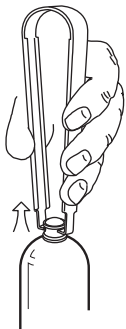

Method B — Without the Seal Guide

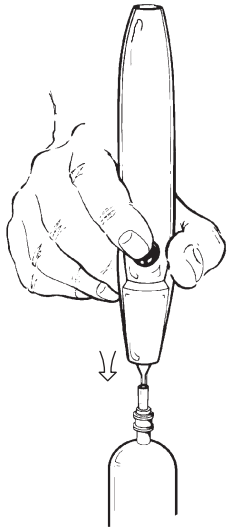

NOTE Always apply the tip of the Tube Topper vertically to the seal former. Apply gentle pressure when sealing the tube.

1.
 - a. Turn the Tube Topper pushbutton to USE position. Press the pushbutton and wait 3 to 5 seconds for the tip to heat.
 - b. Apply the tip of the Tube Topper vertically to the seal former. The seal former should move down the tube stem until it just rests on the tube shoulder. Be careful NOT to press the seal former into the tube shoulder; it may cause the tube to leak.

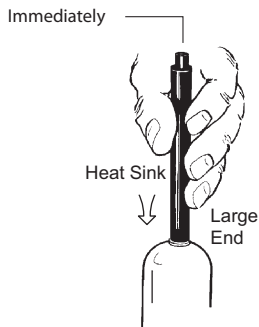

NOTE It is very important to apply the heat sink immediately. To do so, we recommend that you have it in one hand, ready to apply as soon as needed.

Remove the Tube Topper. IMMEDIATELY place the large end of the heat sink over the seal former. Hold it there for a few seconds while the plastic cools—do NOT let the seal former pop up. (If the seal former does pop up, the tube may not have an adequate seal and may need to be resealed.)

Remove the heat sink. When the seal former cools, remove it by hand or with the removal tool (361668).

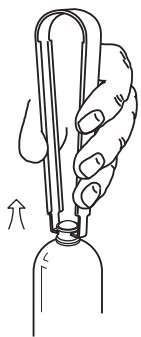

1. After completing either heat-sealing method, squeeze the tube gently (if the tube contents may be disturbed) to test the seal for leaks. If the tube does leak, try resealing it using Method A.
2. The tube is now ready for centrifugation. Seal the remaining tubes.
3. Return the Tube Topper to its charging stand when finished.

Filling Open-Top Tubes

Open-Top Polypropylene Tubes

Open-top polypropylene tubes are used in swinging bucket and fixed-angle rotors.

Swinging-Bucket Rotors

Fill all opposing tubes to the same level.

- *Thinwall Tubes*—Fill to within 2 or 3 mm of the top for proper tube wall support.
- *Thickwall Tubes*—Fill at least half full.

Fixed-Angle Rotors

Fill all opposing tubes to the same level.

- *Thinwall Tubes*—Must be completely filled; liquid and cap or support of the tube wall is critical.
- *Thickwall Tubes*—Can be partially filled and centrifuged as indicated in the applicable rotor manual. Speed reductions may be required for these partially filled tubes. For greater fill volumes and faster speeds, tube caps should be used. Refer to the applicable rotor manual for fill volumes and speed limitations.

Other Open-Top Tubes

Open-top tubes of other materials can also be used in fixed angle and swinging-bucket rotors. (Vertical-tube and near-vertical tube rotors use only OptiSeal or Quick-Seal tubes.) Fill these tubes as indicated below.

Polycarbonate

Thickwall polycarbonate tubes can be centrifuged partially filled. Observe maximum rotor speeds and fill volumes listed in the applicable rotor manual.

Ultra-Clear

For *swinging-bucket* rotors, fill to within 2 or 3 mm of the top of the tube. Fill all opposing tubes to the same level.

Polypropylene

Fill all opposing tubes to the same level.

- For *swinging-bucket* rotors, fill to within 2 or 3 mm of the top of the tube.
- Fill thickwall polypropylene tubes at least half full to maximum level in *fixed-angle* rotors. Speed reduction is required. Refer to the applicable rotor manual.

Polyethylene

For *swinging bucket* and *fixed-angle* rotors, fill these tubes from half full to maximum level. Refer to the applicable rotor manual.

Sample Recovery



If disassembly reveals evidence of leakage, you should assume that some fluid escaped the container or rotor. Apply appropriate decontamination procedures to the centrifuge, rotor, and accessories.

Sample recovery depends on the type of labware used, the component(s) isolated, and the analysis required. The Beckman Coulter Fraction Recovery System (342025) and adapter (347828) can be useful when recovering sample from tubes.

Open-Top Tubes

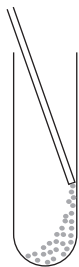

The usual methods of recovering supernatants or pellets include decanting or withdrawing the gradient and scraping pellets from the tube bottom.

If tubes will be reused, scrape pellets out with a plastic or wooden tool; scratches on tube interiors caused by abrasive or sharply pointed tools can result in tube failure during subsequent runs.

OptiSeal Tubes

Centrifugation exerts high forces on plastic labware. The effect of these forces on OptiSeal labware is compression of the tube, characterized by tube deformation that, even if slight, causes a decrease in internal volume. OptiSeal labware is designed to contain the resulting slight pressure increase during separation, as well as during normal post-separation handling. However, a small volume ($\gg 50 \mu\text{L}$) of fluid may occasionally leak from around the plug onto the tube stem area as a plug is removed. Therefore, we recommend using a tissue to contain escaped fluid when extracting plug assemblies from tubes.

- 1 After centrifugation, use the spacer removal tool (338765) or a hemostat to carefully remove the spacers, taking care not to scratch the rotor cavities.

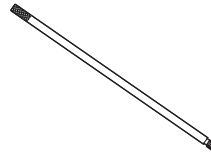

Spacer Removal Tool

- (A tube will sometimes come out of the rotor cavity along with the spacer.)
- a. Separate the tube from the spacer with a twisting motion.)

NOTE Centrifugation causes a slight vacuum to build up in the tube cavity, occasionally resulting in a suction effect when removing the tubes from the rotor. This effect is especially pronounced in a rotor that has been centrifuged at a low temperature. A brief delay (approximately 5 minutes) after the rotor comes to rest before removing the tubes will make tube removal easier. If you experience difficulties in removing the tubes from the rotor, use a gentle twisting or rocking motion, and remove the tube slowly to avoid sample mixing.

- 2 Remove the tube with the extraction tool (361668), grasping the base of the stem only—do NOT try to remove the tubes by pulling on the plugs.

- Some tube deformation occurs during centrifugation, which causes a slight internal pressure to develop inside the tube.

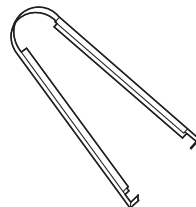
Extraction Tool
(361668)

- 3 Place the tubes back into the tube rack.

- Openings in the rack allow the tubes to be pierced either from the bottom or sides, permitting fractions to be easily collected regardless of the type of separation.

NOTE If you plan to collect particles from the tube side or bottom, first create an air passage by removing the tube plug (see instructions below) or inserting a hollow hypodermic needle in the top of the tube.

- 4** Use one of the following methods to retrieve the sample:
- Puncture the side of the tube just below the sample band with a needle and syringe and draw the sample off.
 - Take care when piercing the tube to avoid pushing the needle out the opposite side.

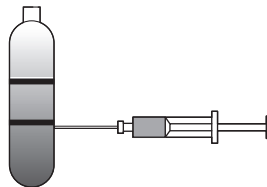

- Puncture the bottom of the tube and collect the drops.

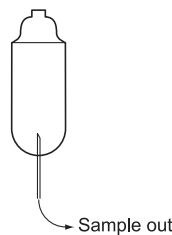

- Aspirate the sample from the tube top by removing the tube plug (see instructions below), then aspirating the sample with a Pasteur pipette or needle and syringe.



- Slice the tube using the Beckman CentriTube Slicer (347960) and CentriTube Slicer Adapter (354526).
 - (Tubes are pressurized after centrifugation, so pierce the tube top with a needle to relieve pressure before slicing.)

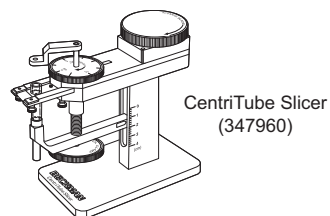

Removing Plugs from Tubes

- 1 Place the tube rack insert over the tubes in the rack.
- 2 Press down on the rack insert on each side of the tube being unplugged to hold the tube in place during plug removal.

NOTE Do not hold onto or squeeze the tubes. Tube contents will splash out when the plug is removed if pressure is applied to the tube.

- 3 While pressing down on the rack insert, use the extraction tool to firmly grasp the plug.

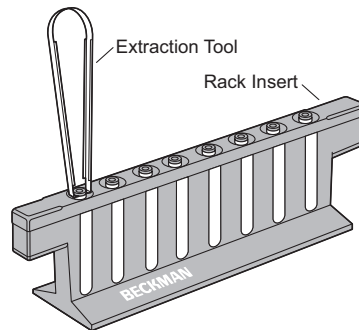

- 4 Use a slight twisting motion to slowly release any residual internal pressure when pulling the plug assembly from the tube.
 - 5 Repeat for each tube.
-

Quick-Seal Tubes

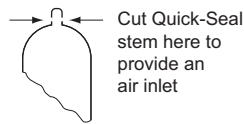

There are several methods of recovering fractions from Quick-Seal tubes. One of the following procedures may be used.

NOTE If you plan to collect particles from the tube side or bottom, first create an air passage by snipping the stem or inserting a hollow hypodermic needle in the top of the tube.

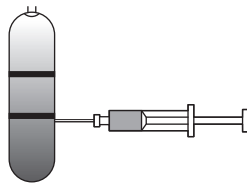

- Puncture the side of the tube just below the band with a needle and syringe and draw the sample off. Take care when piercing the tube to avoid pushing the needle out the opposite side.

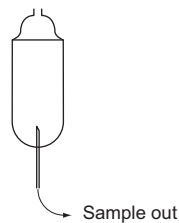

- Puncture the bottom of the tube and collect the drops.

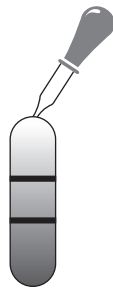

- Aspirate the sample from the tube top by snipping off the tube stem, then aspirating the sample with a Pasteur pipette or needle and syringe.

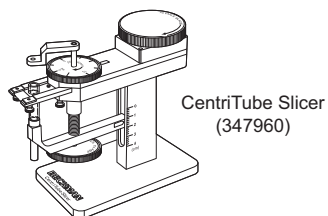

- Slice the tube, using the Beckman CentriTube Slicer (347960) and adapter (354526).

For additional information on fraction recovery systems available from Beckman Coulter, refer to the latest edition of *Ultracentrifuge Rotors, Tubes & Accessories* (publication BR-8101), available at www.beckmancoulter.com.

Making Ultra-Clear Tubes Wettable

The following method of making Ultra-Clear tubes wettable has proven successful for some users:

1. Polyvinyl alcohol (2 g) was dissolved in distilled water (50 mL) by stirring and heating to gentle reflux.
2. Isopropanol (50 mL) was slowly added to the hot solution and stirring and heating continued until a clear solution was obtained.
3. The solution was then allowed to cool to room temperature.
4. Ultra-Clear tubes were filled with the coating solution, then aspirated out with a water pump after 15 minutes, leaving a thin film on the tube walls. A small amount of solution that collected in the tube bottoms after standing was removed with a pipette.
5. The tubes were left open to dry at room temperature overnight, then filled with distilled water. After standing overnight at room temperature, the distilled water was poured out.
6. Finally, the tubes were briefly flushed with water, tapped to remove excess liquid, and left to dry.

Using Rotors

Introduction

This section contains instructions for using rotors in tabletop preparative ultracentrifuges. In addition to these instructions, observe procedures and precautions provided in the applicable rotor and ultracentrifuge manuals.

Refer to [CHAPTER 2](#) for labware selection information, and [CHAPTER 3](#) for recommended filling and sealing or capping requirements and for sample recovery procedures. Refer to [CHAPTER 5](#) for information on the care of rotors and accessories.

NOTE Although rotor components and accessories made by other manufacturers may fit in the Beckman Coulter rotor you are using, their safety in the rotor cannot be ascertained by Beckman Coulter. Use of other manufacturers' components or accessories in a Beckman Coulter rotor may void the rotor warranty, and should be prohibited by your laboratory safety officer. Only the components and accessories listed in the applicable rotor manual should be used.

Fixed-Angle Rotors

Description

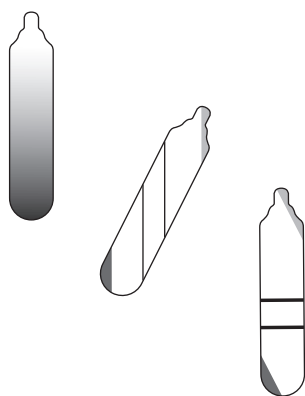

Fixed-angle rotors (see [Figure 4.1](#)) are general-purpose rotors that are especially useful for pelleting and isopycnic separations. Refer to [Table 1.1](#) for general rotor specifications.

Tubes in fixed-angle rotors are held at an angle (usually 20 to 45 degrees) to the axis of rotation in numbered tube cavities. The tube angle shortens the particle pathlength compared to swinging-bucket rotors, resulting in reduced run times.

Fixed-angle rotors have lids with O-rings, made of Buna N rubber. The O-rings help to maintain atmospheric pressure inside the rotor during centrifugation, if they are properly lubricated.

Figure 4.1 Fixed-Angle Rotor

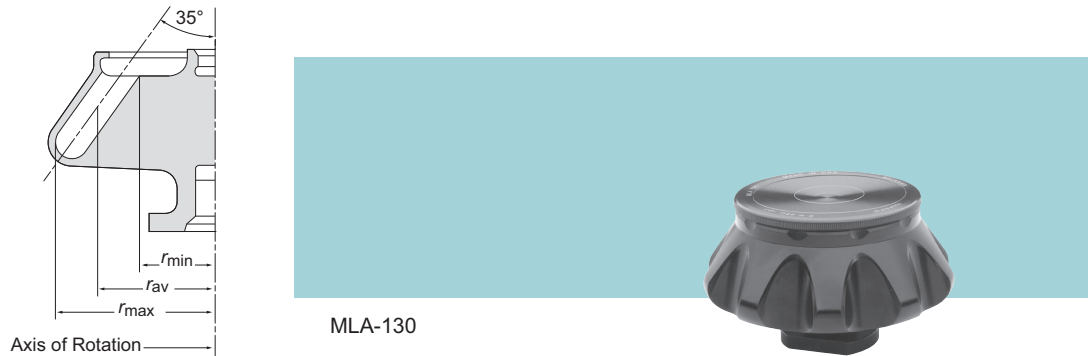

Each fixed-angle rotor is specially designed with a fluid-containment annulus located below the O ring sealing surface. The annulus retains fluid that may escape from leaking or overfilled tubes, thereby preventing the liquid from escaping into the instrument chamber.

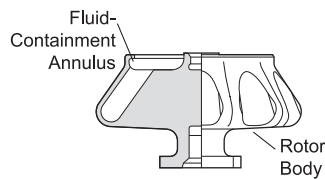

Some rotors have fluted bodies, designed to eliminate unnecessary weight and minimize stresses.

Tubes

Fixed-angle rotors can accommodate a variety of tube types, listed in the rotor manual. Refer to [CHAPTER 3](#) for tube filling and sealing requirements. Observe the maximum rotor speeds and fill volumes listed in the applicable rotor manual.

Rotor Preparation and Loading

For runs at other than room temperature, refrigerate or warm the rotor beforehand for fast equilibration.

Prerun Safety Checks



Read all safety information in the rotor manual before using the rotor.

- 1 Make sure that the rotor and lid are clean and show no signs of corrosion or cracking.
- 2 Check the chemical compatibilities of all materials used. (Refer to [APPENDIX A.](#))
- 3 Verify that tubes and accessories being used are listed in the applicable rotor manual.

Rotor Preparation and Loading

- 1 Be sure that metal threads in the rotor are clean and lightly but evenly lubricated with Spinkote lubricant (306812).
 - a. Also ensure that O-rings are lightly but evenly coated with silicone vacuum grease (335148).
-

- 2 Dry the exterior of the tubes.
 - (Moisture between the tube and the rotor cavity may lead to tube collapse and increase the force required to extract the tube.)
 - a. Slide the filled and sealed (if required) tubes into the tube cavities.
 - Tubes must be arranged symmetrically in the rotor (see [Figure 1.5](#)).
 - Opposing tubes must be filled to the same level with liquid of the same density.
 - Refer to [Rotor Balance](#) in [CHAPTER 1](#).

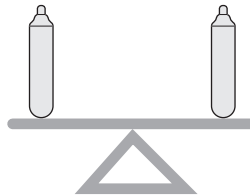

NOTE Place filled tubes in at least two opposing cavities. Make sure that cavities in use also have the proper spacers inserted before installing the rotor lid. Do not put spacers in cavities that do not contain tubes.

- 3 Use the required spacers and/or floating spacers, if necessary, to complete the loading operation.
 - a. If OptiSeal tubes are being used, install a spacer over each plugged tube (refer to the applicable rotor manual).

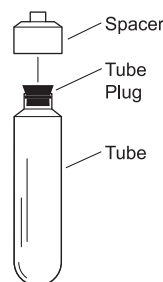

- 1) Leave cavities without tubes completely empty.

- b. If Quick-Seal tubes are being used, install spacers and/or floating spacers over sealed tubes (refer to the applicable rotor manual).

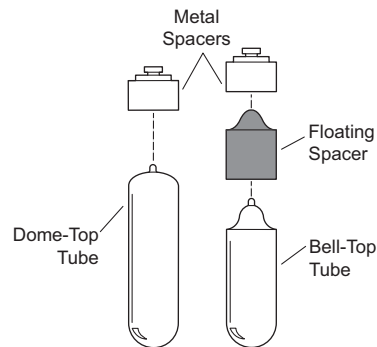

- The particular type of tube support for Quick-Seal tubes in fixed-angle rotors depends on the length of the tube, but the top of the tube must be supported.

- 1) Leave cavities without tubes completely empty.

4 After the rotor is loaded, insert it into the portable polypropylene rotor vise (346133).

- a. Place the lid on the rotor and tighten it firmly to the right (clockwise) by hand.

- No tool is required.
-

Operation

For runs at other than room temperature, refrigerate or warm the rotor beforehand for fast equilibration.

Installing the Rotor

1 Use an absorbent towel to wipe off condensation from the rotor, then carefully place the rotor on the drive hub.

2 TL series rotors—Lock the rotor in place by gently pressing the plunger down until you feel it click.

- a. When you remove your finger, the plunger will remain flush with the rotor body if it is properly engaged.

- b. If the plunger pops up, repeat the procedure.

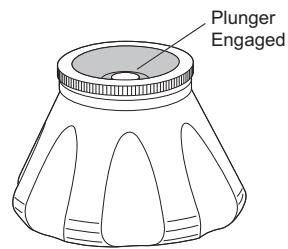

(The Optima MAP-XP, MAX-TL, MAX, and MAX-E ultracentrifuges automatically secure the rotor to the drive shaft without the need for engaging the plunger.)

CAUTION

In all tabletop ultracentrifuge models except the Optima MAX-XP, MAX-TL, MAX, and MAX-E, it is very important to lock the rotor in place before beginning the run to ensure that the rotor remains seated during centrifugation. Failure to lock the rotor in place before beginning the run may result in damage to both rotor and instrument.

- 3 Refer to the instrument instruction manual for ultracentrifuge operation.

Removal and Sample Recovery

CAUTION

If disassembly reveals evidence of leakage, you should assume that some fluid escaped the rotor. Apply appropriate decontamination procedures to the centrifuge and accessories.

- 1 TL series rotors—To release the plunger at the end of the run, gently press it down until you feel it click.
- When you remove your finger the plunger will pop up to its released position.

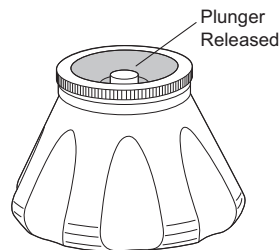

- 2 Remove the rotor from the ultracentrifuge and place it in the rotor vise.

3 Remove the lid by unscrewing it to the left (counterclockwise).

4 Use a tube removal tool to remove the spacers and tubes.

Swinging-Bucket Rotors

Description

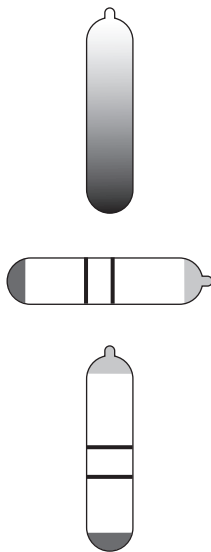

Swinging-bucket rotors (see [Figure 4.2](#)) are most frequently used for density gradient separations, either isopycnic or rate zonal. Refer to [Table 1.1](#) for general rotor specifications.

Tubes in swinging-bucket rotors are held in the rotor buckets. Buckets are attached to the rotor body by hinge pins or a crossbar. The buckets swing out to a horizontal position as the rotor accelerates, then seat against the rotor body for support. Bucket and rotor body positions are numbered for operator convenience. Each bucket is sealed by a lubricated O-ring between the bucket and the bucket cap.

When not in the instrument, the rotor body must be supported on its rotor stand to permit the buckets to hang properly.

Figure 4.2 Swinging-Bucket Rotor

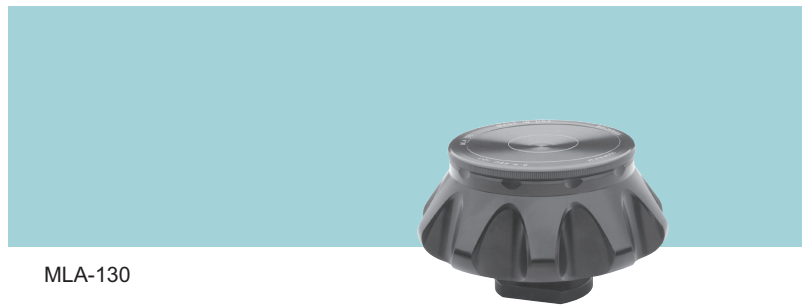
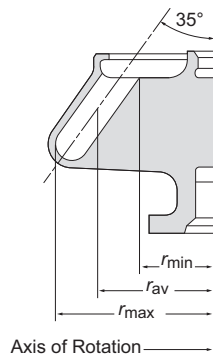

MLA-130

Tubes

Swinging bucket rotors can accommodate a variety of tube types, listed in the applicable rotor manual. Refer to [CHAPTER 3](#) for tube filling and sealing requirements. Observe the maximum rotor speeds and fill volumes listed in the rotor manual.

Rotor Preparation and Loading

For runs at other than room temperature, refrigerate or warm the rotor beforehand for fast equilibration.

NOTE All buckets, loaded or empty, must be positioned on the rotor body for every run.

Prerun Safety Checks

Read all safety information in the rotor manual before using the rotor.



- 1 Make sure that the rotor body, buckets, and bucket caps are clean and show no signs of corrosion or cracking.
- 2 Check the chemical compatibilities of all materials used. (Refer to [APPENDIX A.](#))
- 3 Verify that tubes and accessories being used are listed in the applicable rotor manual.

Rotor Preparation and Loading

- 1 Be sure that bucket threads are clean and lightly but evenly lubricated with Spinkote lubricant (306812), as required.
- 2 Remove the bucket O-rings and coat them lightly but evenly with silicone vacuum grease (335148).
 - a. Install O-rings in the buckets.

 **CAUTION**

Never run a filled bucket without an O-ring, as the bucket contents may be lost, leading to rotor imbalance and possible failure.

-
- 3** Dry the exterior of the tubes.
- (Moisture between the tube and the bucket may lead to tube collapse and increase the force required to extract the tube.)
- a.** Slide the filled and sealed tubes into the buckets.
- Loaded buckets can be supported in the bucket holder rack available for each rotor.
-

- 4** Use the required spacers and/or floating spacers, if necessary, to complete the loading operation.
- a.** If OptiSeal tubes are being used, install a spacer over each plugged tube (refer to the applicable rotor manual).

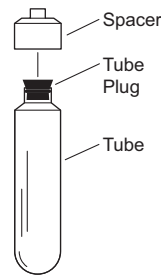

- 1)** Leave buckets without tubes completely empty.
- b.** If Quick-Seal tubes are being used, install spacers and/or floating spacers over sealed tubes (refer to the applicable rotor manual).

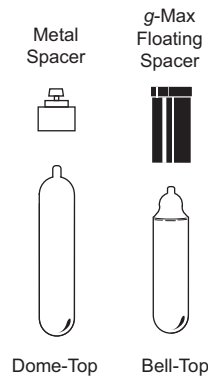

- The particular type of tube support for Quick-Seal tubes in swinging-bucket rotors depends on the length of the tube, but the top of the tube must be supported.

- 1)** Leave buckets without tubes completely empty.
-

- 5** Match numbered caps with numbered buckets.
- a.** Screw the caps into the bucket until there is metal-to-metal contact.

- 6 Attach numbered buckets, loaded or empty, to corresponding rotor body positions.
 - Loaded buckets must be arranged symmetrically on the rotor (see [Figure 1.5](#)).
 - Opposing tubes must be filled to the same level with liquid of the same density.
 - Refer to [Rotor Balance](#) in [CHAPTER 1](#).

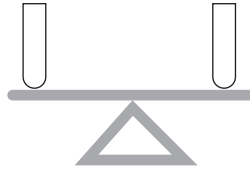

NOTE Two tubes can be run if the filled buckets are attached in opposing positions on the rotor (positions 1 and 3, or 2 and 4), and the two remaining buckets are also attached. (If you regularly run only two filled buckets, alternate the placement—positions 1 and 3, then 2 and 4—to ensure even wear on the rotor.) Remember, all four buckets must be attached to the rotor, whether they are loaded or empty. Attach the buckets to the rotor before installing it in the instrument. Trying to attach them after the rotor is installed may cause damage to the drive shaft.

Operation

For runs at other than room temperature, refrigerate or warm the rotor beforehand for fast equilibration.

Installing the Rotor

- 1 To install the rotor, carefully lift it with both hands and place it on the drive hub.

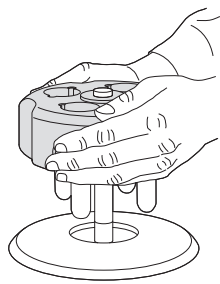

- 2 TL series rotors—lock the rotor in place by gently pressing the plunger down until you feel it click.
 - When you remove your finger, the plunger will remain flush with the rotor body if it is properly engaged.

- a. If the plunger pops up, repeat the procedure.

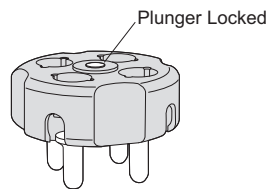

CAUTION

In all tabletop ultracentrifuge models except the Optima MAX-XP, MAX-TL, MAX, and MAX-E, it is very important to lock the rotor in place before beginning the run to ensure that the rotor remains seated during centrifugation. Failure to lock the rotor in place before beginning the run may result in damage to both rotor and instrument.

- 3 Refer to the instrument instruction manual for ultracentrifuge operation.

Removal and Sample Recovery

CAUTION

If disassembly reveals evidence of leakage, you should assume that some fluid escaped the rotor. Apply appropriate decontamination procedures to the centrifuge and accessories.

- 1 TL series rotors—to release the plunger at the end of the run, gently press it down until you feel it click.
 - When you remove your finger the plunger will pop up to its released position.

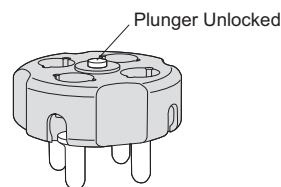

- 2 Remove the rotor from the ultracentrifuge and return it to its stand.
- 3 Detach the buckets from the rotor body.

- 4 Unscrew the bucket caps, then use the appropriate removal tool to remove the tubes.

NOTE If conical-shaped adapters that support konical tubes are difficult to remove after centrifugation, an extractor tool (354468) is available to facilitate removal.

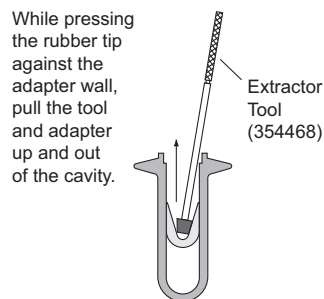

- 5 Refer to [CHAPTER 3](#) for sample recovery methods.

Vertical-Tube and Near-Vertical Tube Rotors

Vertical-tube and near-vertical tube rotors are especially useful for isopycnic banding and rate zonal experiments. Some rotors have fluted bodies, designed to eliminate unnecessary weight and minimize stresses. Refer to [Table 1.1](#) for general rotor specifications.

Vertical-Tube Rotors Description

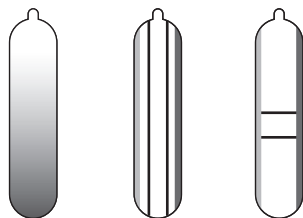

Tubes in vertical-tube rotors (see [Figure 4.3](#)) are held parallel to the axis of rotation in numbered tube cavities. These rotors have plugs that are screwed into the rotor cavities over sealed OptiSeal or Quick-Seal tubes. The plugs (with spacers, when required) restrain the tubes in the cavities and provide support against the hydrostatic force generated by centrifugation.

Figure 4.3 Vertical-Tube Rotor

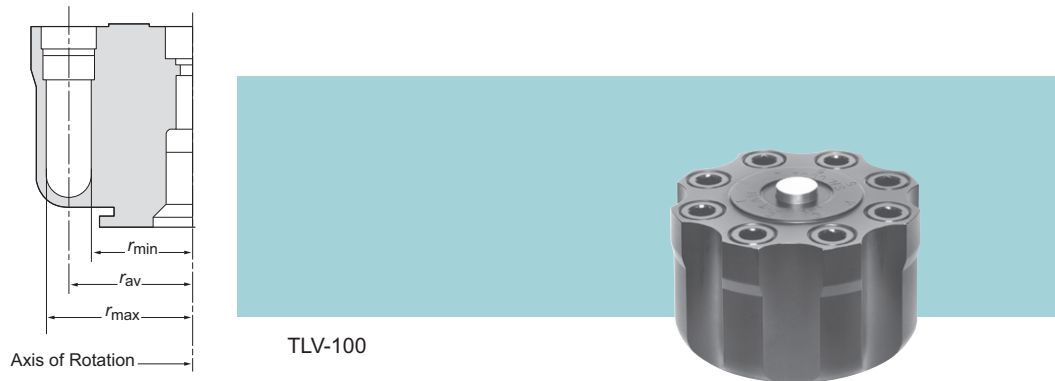

Near-Vertical Tube Rotors Description

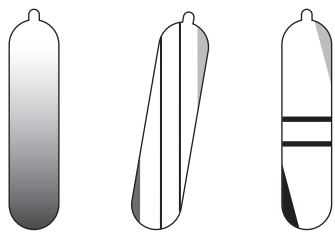

Tubes in near-vertical tube rotors (see [Figure 4.4](#)) are held in numbered tube cavities at an angle to the axis of rotation (typically 7 to 10 degrees). The slight angle of the rotor significantly reduces run times from fixed angle rotors (with tube angles of 20 to 45 degrees) while allowing components that do not band under separation conditions to either pellet to the bottom or float to the top of the tube. Like the vertical-tube rotors, these rotors have plugs to restrain and support sealed OptiSeal or Quick-Seal tubes.

Figure 4.4 Near-Vertical Tube Rotor

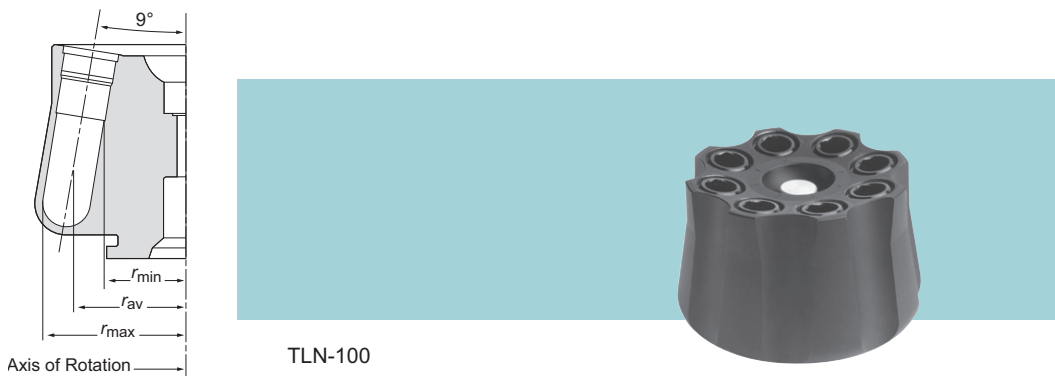

Tubes

Only OptiSeal or Quick-Seal tubes are used in these rotors. Refer to [CHAPTER 3](#) for tube filling and sealing or plugging requirements. Observe the maximum rotor speeds and fill volumes listed in the applicable rotor manual.

Rotor Preparation and Loading

For runs at other than room temperature, refrigerate or warm the rotor beforehand for fast equilibration.

Prerun Safety Checks



Read all safety information in the rotor manual before using the rotor.

- 1 Make sure that the rotor, plugs, gaskets, and spacers are clean and show no signs of corrosion or cracking.
 - The high forces generated in these rotors can cause damaged components to fail.
- 2 Check the chemical compatibilities of all materials used.
 - (Refer to [APPENDIX A](#).)
- 3 Verify that tubes and accessories being used are listed in the applicable rotor manual.

Rotor Preparation and Loading

- 1 Be sure that plug threads are clean and lightly but evenly lubricated with Spinkote lubricant (306812).

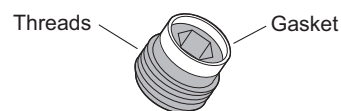

- 2 Set the rotor into the vise, which should be bolted or clamped to a rigid surface.
- 3 Dry the exterior of the plugged (OptiSeal) or sealed (Quick-Seal) tubes.
 - (Moisture between the tube and the rotor cavity may lead to tube collapse and increase the force required to extract the tube.)
 - a. Slide the tubes into the tube cavities.
 - Tubes must be arranged symmetrically in the rotor (see [Figure 1.5](#)).

- Opposing tubes must be filled to the same level with liquid of the same density.
 - Refer to *Rotor Balance* in CHAPTER 1.

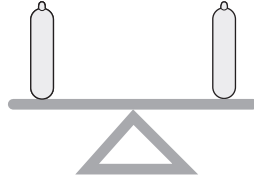

- 1) Place filled tubes in at least two opposing cavities.

4 It is important that each cavity being used is completely filled.

- Use the required spacers and/or floating spacers, if necessary, to complete the loading operation.
- a. If OptiSeal tubes are being used, install a spacer over each plugged tube (refer to the applicable rotor manual).

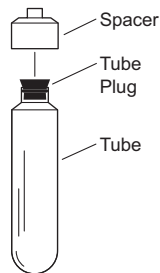

- 1) Leave cavities without tubes completely empty.

- b. If Quick-Seal tubes are being used, install spacer and/or floating spacers over sealed tubes (refer to the applicable rotor manual).

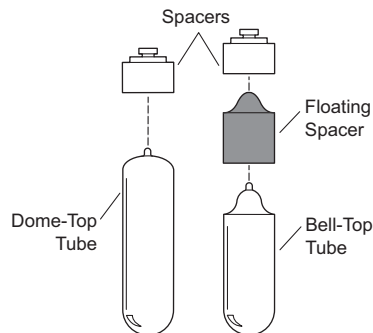

- The particular type of tube support for Quick-Seal tubes depends on the length of the tube, but the top of the tube must be supported.

- 1) Leave cavities without tubes completely empty.

CAUTION

To prevent plug damage, do not put spacers or plugs in cavities that do not contain tubes. Leave unused tube cavities completely empty.

- 5 Insert a rotor plug, with the white gasket-end down, over each spacer; screw in the plug.
- 6 Using the plug adapter and torque wrench listed in the rotor manual, torque each rotor plug to 13.6 N•m (120 in.-lb).
 - a. To avoid stripping the plugs, apply downward pressure to the adapter while tightening the plugs.
 - Do not overtighten plugs.

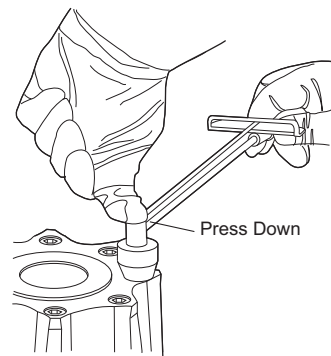

- 7 Remove the rotor from the vise.

Operation

For runs at other than room temperature, refrigerate or warm the rotor beforehand for fast equilibration.

Installing the Rotor

- 1 Use an absorbent towel to wipe off condensation from the rotor, then carefully place the rotor on the drive hub.

- 2 TL series rotors—lock the rotor in place by gently pressing the plunger down until you feel it click.
 - When you remove your finger, the plunger will remain flush with the rotor body if it is properly engaged.
 - a. If the plunger pops up, repeat the procedure.

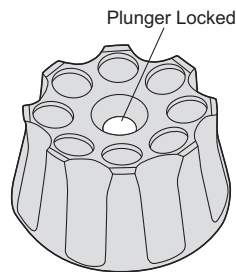

(The Optima MAX-XP, MAX-TL, MAX, and MAX-E ultracentrifuges automatically secure the rotor to the drive shaft without the need for engaging the plunger.)

CAUTION

In all tabletop ultracentrifuge models except the Optima MAX-XP, MAX-TL, MAX, and MAX-E, it is very important to lock the rotor in place before beginning the run to ensure that the rotor remains seated during centrifugation. Failure to lock the rotor in place before beginning the run may result in damage to both rotor and instrument.

- 3 Refer to the centrifuge instruction manual for detailed operating information.
-

Removal and Sample Recovery

CAUTION

If disassembly reveals evidence of leakage, you should assume that some fluid escaped the rotor. Apply appropriate decontamination procedures to the centrifuge and accessories.

- 1 TL series rotors—to release the plunger at the end of the run, gently press it down until you feel it click.
 - When you remove your finger the plunger will pop up to its released position.

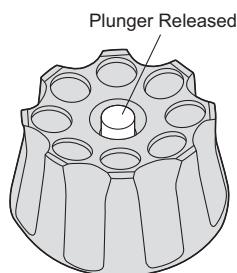

- 2 Remove the rotor from the ultracentrifuge and place it in the rotor vise.
- 3 Remove the rotor plugs, taking care to apply downward pressure on the plug adapter to avoid stripping the plugs.
- 4 Remove spacers with the appropriate removal tool or a hemostat.
 - a. Use removal tool (338765) to remove floating spacers.

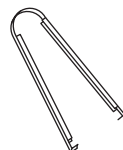

Tube
Removal Tool
(361668)

- 5 Remove tubes with the extraction tool (361668).
- 6 Refer to [CHAPTER 3](#) for sample recovery methods.

Using Rotors

Vertical-Tube and Near-Vertical Tube Rotors

Care and Maintenance

Introduction

This section provides information on the care of rotors and accessories. Included is a list of some common operating problems with suggestions for their solutions. Rotors and accessories should be kept in optimal condition to minimize the chance of rotor or labware failure. In addition to these instructions, observe procedures and precautions provided in individual rotor manuals. Appendix A of this manual provides the chemical resistances of rotor and accessory materials to various acids, bases, salts, and solvents.

Rotor Care

Rotor care involves not only careful operating procedures but also careful attention to:

- Regular cleaning, decontamination, and/or sterilization as required,
- Frequent inspection,
- Corrosion prevention, and
- Regular and proper lubrication.

Do not use sharp tools on a rotor, as the surface can get scratched. Corrosion begins in scratches and may open fissures in the rotor with continued use. The corrosion process accelerates with speed-induced stresses. The potential for damage from corrosion is greatest in aluminum rotors and components.

Cleaning

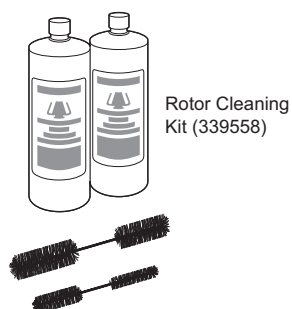

Wash rotors and rotor components immediately if salts or other corrosive materials are used or if spillage has occurred. DO NOT allow corrosive materials to dry on the rotor.

NOTE Do not wash rotor components or accessories in a dishwasher. Do not soak in detergent solution for long periods, such as overnight.

With normal usage, wash rotors frequently to prevent corrosion that can begin in scratches.

 **CAUTION**

Do not immerse or spray a swinging bucket rotor body with water because liquid can become trapped in the hanger mechanism and lead to corrosion.

- 1 Use plastic or wooden tools to remove O-rings or gaskets for cleaning—do not use metal tools that could scratch anodized surfaces.
 - a. Use a mild detergent such as Beckman Solution 555 (339555), diluted 10 to 1 with water, and a soft brush to wash rotors and rotor components and accessories.
 - (Most laboratory detergents are too harsh for aluminum rotors and components.)
 - The Rotor Cleaning Kit (339558) contains two quarts of Solution 555 and brushes that will not scratch rotor surfaces.

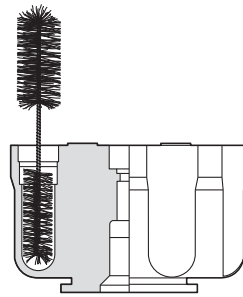

- 2 Rinse thoroughly with water.
- 3 Air-dry the body or buckets upside down.
 - a. Do not use acetone to dry rotors.
- 4 Wipe clean the O-rings or gaskets regularly (lubricate after cleaning).
 - a. Replace them about twice a year or as required.
- 5 Frequently clean all surfaces that contact O-rings.
 - a. Regularly clean the threads of the rotor (lid, plugs, buckets, cavities, and so on) with a nonmetal brush and a small amount of concentrated detergent, then rinse, and dry thoroughly.
 - b. Lubricate the threads as directed under [Lubrication](#), below.

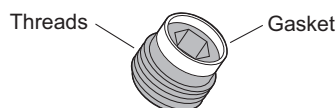

Decontamination

Rotors contaminated with radioactive or pathogenic materials must be decontaminated, following appropriate laboratory safety guidelines and/or other regulations.

NOTE Strong bases and/or high-pH solutions can damage aluminum rotors and components.



- If a rotor (and/or accessories) becomes contaminated with radioactive material, it should be decontaminated using a solution that will not damage the anodized surfaces. Beckman Coulter has tested a number of solutions and found two that do not harm anodized aluminum: RadCon Surface Spray or IsoClean Solution (for soaking),* and Radiacwash.†

NOTE IsoClean can cause fading of colored anodized surfaces. Use it only when necessary, and do not soak rotor components longer than the minimum time specified in the IsoClean usage instructions. Then remove it promptly from surfaces.

While Beckman Coulter has tested these methods and found that they do not damage components, no guarantee of decontamination is expressed or implied. Consult your laboratory safety officer regarding the proper decontamination methods to use.



- If the rotor or other components are contaminated with toxic or pathogenic materials, follow appropriate decontamination procedures as outlined by appropriate laboratory safety guidelines and/or other regulations. Consult [APPENDIX A](#) to select an agent that will not damage the rotor.

Sterilization and Disinfection

When sterilization or disinfection is a concern, consult your laboratory safety officer regarding proper methods to use. While Beckman Coulter has tested the following methods and found that they do not damage the rotor or components, no guarantee of sterility or disinfection is expressed or implied.

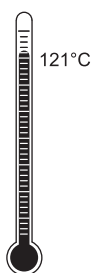

- Rotors and most rotor components, except those made of Noryl, can be autoclaved at 121°C for up to an hour. Remove the lid, bucket caps, or rotor plugs and place the rotor (and/or buckets) in the autoclave upside-down. (O-rings and gaskets can be left in place on the rotor.)
- Ethanol (70%)‡ may be used on all rotor components, including those made of plastic. Bleach (sodium hypochlorite) may be used, but may cause discoloration of anodized surfaces. Use the minimum immersion time for each solution, per laboratory standards.

Inspection

Frequent and thorough inspection is crucial to maintaining a rotor in good operating condition.

* In U.S., contact Nuclear Associates (New York); in Eastern Europe and Commonwealth States, contact Victoreen GmbH (Munich); in South Pacific, contact Gammasonics Pty. Ltd. (Australia); in Japan, contact Toyo Medic Co. Ltd. (Tokyo).

† In U.S., contact Biodex Medical Systems (Shirley, New York); internationally, contact the U.S. office to find the dealer closest to you.

‡ Flammability hazard. Do not use in or near operating ultracentrifuges.

- 1 Periodically (at least monthly, depending on use) inspect the rotor, especially inside cavities and buckets, for rough spots, cracks, pitting, white powder deposits on aluminum rotors (frequently aluminum oxide), or heavy discoloration.
 - a. If any of these signs are evident, do not run the rotor.
 - b. Contact your Beckman Coulter representative for information about the Field Rotor Inspection Program and the Rotor Repair Program.

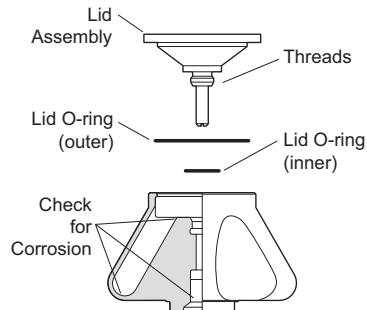

- 2 Regularly check the condition of O-rings and replace any that are worn or damaged.
- 3 Regularly check that all sealing surfaces are smooth and undamaged to ensure proper sealing.
- 4 Regularly check the condition of rotor plugs (a component of vertical-tube and near-vertical tube rotors) and rotor plug gaskets.
 - a. Replace worn or damaged gaskets.

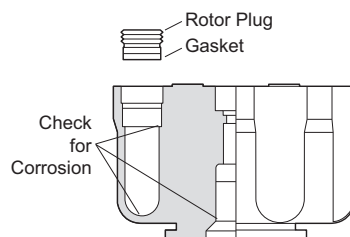

Field Rotor Inspection Program

The Field Rotor Inspection Program (FRIP) has two purposes:

1. to prevent premature rotor failures by detecting conditions such as stress, corrosion, metal fatigue, damage, or wear in the anodized coatings; and
2. to instruct laboratory personnel in the proper care of rotors.

Beckman Coulter has trained a group of experienced service engineers in the techniques of nondestructive evaluation. For more information about the program, contact your Beckman Coulter representative.

Lubrication

Proper lubrication is essential to obtain specified torque values, where required, and to minimize thread wear.

- Many rotors use O-rings as seals to maintain atmospheric pressure in the rotor during a run. These O-rings and the surfaces they bear against must be kept clean and evenly lubricated. After removing and cleaning rotor O-rings or gaskets, lightly but evenly coat them with silicone vacuum grease (335148) and reposition them in the rotor.
- After cleaning metal threads, lubricate them with Spinkote lubricant (306812). *Failure to keep threads properly lubricated can result in stripped or galled threads and stuck rotor components.*
- Rotor plug gaskets (a component of vertical tube and near vertical tube rotors) do NOT require lubrication, but should be checked, cleaned, and or replaced as required.

Tube and Accessory Care

Proper care of tubes involves observing temperature, fill volume, and run speed limitations as well as careful cleaning and sterilization procedures.

Cleaning

Do not wash tubes in a commercial dishwasher — detergents and temperatures are too harsh.

- 1 Wash tubes, adapters, and other accessories by hand, using a mild detergent, such as Solution 555 (339555) diluted 10 to 1 with water, and a soft brush.
- 2 Polycarbonate tubes are vulnerable to attack by alkaline solutions and detergents, so use a detergent with pH less than 9, such as Solution 555.
 - a. Do not use a brush with exposed metal; scratches in polycarbonate will cause early failure.

- 3 Alcohol and acetone react unsatisfactorily with many tube and accessory materials.
 - If a solvent must be used to rinse, dry, or decontaminate these materials, consult [APPENDIX A](#) to select an appropriate solvent.
- 4 Do not dry tubes or accessories in an oven.
 - Labware should be air-dried.
- 5 OptiSeal, Quick-Seal, Ultra-Clear, and thinwall polypropylene tubes are intended for one-time use and should be discarded after use.

Decontamination



Labware contaminated with radioactive or pathogenic solutions should be decontaminated or disposed of following appropriate safety guidelines and/or regulations. Consult [APPENDIX A](#) to select an agent that will not damage the tube material.

Sterilization and Disinfection

Refer to [Table 5.1](#) for sterilization methods recommended for each container type.

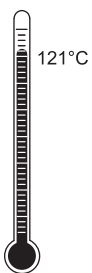

Most tubes and accessories, except those made of Ultra-Clear, polyethylene, cellulose propionate, or Noryl, can be autoclaved at 121°C for about 20 minutes. Note that autoclaving reduces the lifetime of polycarbonate tubes. Also, polypropylene tubes may be permanently deformed if they are autoclaved many times or if they are handled or compressed before they cool. Tubes should be placed open-end down or supported in a rack if autoclaved. Do not autoclave plastic adapters or spacers.



Do not autoclave sealed or capped tubes. Pressure in a sealed container can cause an explosion. Pressures within the autoclave can cause partially sealed containers to collapse when the autoclave vents.

A cold sterilization method, such as immersion in 10% hydrogen peroxide for 30 minutes, may be used on Ultra-Clear tubes. Refer to [Table 5.1](#) to select cold sterilization materials that will not damage tubes and accessories.

Table 5.1 Tube Sterilization and Disinfection^a

Tube Material	Autoclave ^b (121°C)	UV Irradiation	Ethylene Oxide	Formaldehyde	Ethanol (70%) ^c	Sodium Hypochlorite (10%)	Hydrogen Peroxide (10%)	Glutaraldehyde (2%)	Phenolic Derivatives
Ultra-Clear	no	no	yes	yes ^d	yes	yes	yes	yes	no
polycarbonate	yes ^e	no	yes	yes ^d	no	yes ^f	yes	yes	no
polypropylene	yes	no	yes	yes	yes	yes ^g	yes ^h	yes	no
polyethylene	no	no	yes	yes	yes ⁱ	yes	yes	yes	yes
cellulose propionate	no	no	no	no	no	yes	yes	yes	no

- This information is provided as a guide to the use of sterilization and disinfection techniques for tube materials. Cold sterilization results shown are for short-duration (10-minute) soak periods; reactions may differ with extended contact. Refer to Appendix A of this manual for information about specific solutions.
- To avoid deformation, autoclave tubes open-end down in a tube rack at 15 psig for no more than 20 minutes (allow to cool before removing from tube rack). DO NOT autoclave capped or sealed tubes.
- Flammable; do not use in or near operating ultracentrifuges.
- Do not use if there is methanol in the formula.
- Tube life will be reduced by autoclaving.
- Discoloration may occur.
- Can be used if diluted.
- Below 26°C only.
- Below 21°C only.

While Beckman Coulter has tested these methods and found that they do not damage the components, no guarantee of sterility or disinfection is expressed or implied. When sterilization or disinfection is a concern, consult your laboratory safety officer regarding proper methods to use.

Inspection

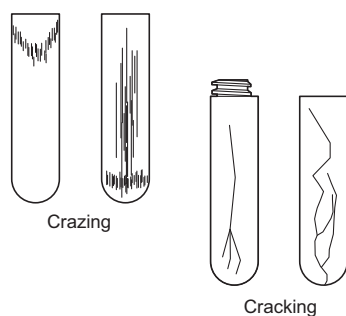

Inspect containers and accessories before use.

- Inspect tubes for cracks or any major deformities before using them.
- Do not use a tube that has become yellowed or brittle with age or excess exposure to ultraviolet light.
- Crazing—the appearance of fine cracks on tubes—is the result of stress relaxation. If a crack approaches the outer wall of the tube, discard it.
- Discard any deformed or cracked adapters.

Tube and Bottle Storage

Tubes have an indefinite shelf life if properly stored. Store in a dark, cool, dry place away from ozone, chemical fumes, and ultraviolet light sources.

Removing Jammed or Collapsed Tubes

Centrifugal force may collapse improperly filled or sealed thinwall tubes. Observe careful filling and capping procedures to prevent tube collapse.

NOTE Centrifugation often causes a slight vacuum to build up in the tube cavity, occasionally resulting in a suction effect when removing the tubes from the rotor. This effect is especially pronounced in a rotor that has been centrifuged at low temperature. A brief delay (approximately 5 minutes) after the rotor comes to rest before removing the tubes can make tube removal easier. If tubes are difficult to remove from the rotor, use a gentle twisting or rocking motion, and remove the tube slowly to avoid sample mixing.

If a tube is jammed or collapsed in the rotor, try one of the following techniques, but **DO NOT** force the tube. Contact Beckman Coulter Field Service if you are unsuccessful.



Do not use a hemostat or any metal tool to pry a jammed or collapsed tube out of the rotor. The rotor can be scratched and damaged.

- If an uncapped polycarbonate tube is stuck, remove tube contents and place the rotor or bucket upside-down in an autoclave for about 30 to 60 minutes. When the rotor is cool enough to handle, try to remove the jammed or collapsed tube. *Do not autoclave sealed or capped tubes.*
- Pour a solvent in the tube to make the tube material more flexible. Several changes of solvent may be necessary to weaken the tube for easy removal. Refer to the chemical resistances list in [APPENDIX A](#) to select a solvent that will not damage the rotor.

Returning a Rotor or Accessory to the Factory

Before returning a rotor or accessory for any reason, prior permission must be obtained from Beckman Coulter, Inc. This form may be obtained from your local Beckman Coulter sales office. The form, entitled Returned Material Authorization (RMA) for United States returns or *Returned Goods Authorization* (RGA) for international returns, should contain the following information:

- rotor type and serial number,
- history of use (approximate frequency of use),
- reason for the return,
- original purchase order number, billing number, and shipping number, if possible,
- name and email address of the person to be notified upon receipt of the rotor or accessory at the factory, and
- name and email address of the person to be notified about repair costs, etc.

To protect our personnel, it is the customer's responsibility to ensure that the parts are free from pathogens, chemical hazards, and/or radioactivity. Sterilization and decontamination **MUST** be done before returning the parts. Smaller items (such as tubes, bottles, and so on) should be enclosed in a sealed plastic bag.

All parts must be accompanied by a note, plainly visible on the outside of the box or bag, stating that they are safe to handle and that they are not contaminated with pathogens, chemical hazards, or radioactivity. Failure to attach this notification will result in return or disposal of the items without review of the reported problem.

Use the address label printed on the RMA/RGA form when mailing the rotor and/or accessories.

Customers located outside the United States should contact their local Beckman Coulter office.

Diagnostic Hints

Some of the more common operating problems experienced in centrifugation are listed in [Table 5.2](#) with suggestions for their solutions. Contact Beckman Coulter Field Service if a problem cannot be corrected.

NOTE Use only the labware listed in the applicable rotor manual.

Table 5.2 Troubleshooting Chart

Symptom	Possible Cause and Suggested Action
Rotors	
Severe vibration	<ul style="list-style-type: none"> • Rotor imbalance. To balance the rotor load, fill all opposing tubes to the same level with liquid of the same density. Weight of opposing tubes must be distributed equally. Place tubes in a fixed-angle, near-vertical tube, or vertical-tube rotor symmetrically, as illustrated in CHAPTER 1 (Figure 1.5). • Swinging-bucket rotor — Mishooked bucket, loose bucket cap, wrong type of bucket, mixed bucket types, opposing buckets not filled to the same level with liquids of the same density. Check loading procedures (refer to CHAPTER 4).
Stripped rotor plugs on vertical tube or near-vertical tube rotors	Rotor vise not used, wrong tool used, incorrect torque, or insufficient pressure on plug adapter, when tightening rotor plugs. Observe careful tightening procedures.
Rotor lid or bucket cap is difficult to remove after centrifugation	Threads contaminated with dirt, dried lubricant, or metal particles, or threads insufficiently lubricated cause rotor components to stick. Do not use excessive force to loosen components. Contact Beckman Coulter Field Service. Routinely clean metal threads with concentrated Solution 555 (339555), then lubricate them with Spinkote (306812).
Paint coming off where bucket contacts rotor pocket on swinging-bucket rotor	Not an operational problem.

Table 5.2 Troubleshooting Chart (*Continued*)

Symptom	Possible Cause and Suggested Action
Tubes	
Tube leakage	
Uncapped tubes	Tube volume exceeds maximum uncapped volume. Refer to the rotor manual for tube volumes and speed reductions.
OptiSeal tubes	Improperly plugged. Make sure that no fluid is trapped in the tube stem, and that the stem is clean and dry before inserting plug. (Refer to CHAPTER 3 for instructions on filling and plugging OptiSeal tubes.)
Quick-Seal tubes	Improperly sealed. After heat-sealing, squeeze the tube gently (if the tube contents may be disturbed) to test the seal for leaks. If the tube leaks, reseal it.
Tube cracking	<ul style="list-style-type: none"> • Tubes may crack or become brittle if they are used below their lower temperature limit. Before using tubes at other than stated temperature limits, evaluate them under centrifugation conditions. If sample is frozen in tubes, make sure that tubes are thawed to at least 2°C before centrifugation. • Tubes may become brittle with age and use. Dispose of brittle or cracked tubes.
Tube collapse	<ul style="list-style-type: none"> • Thinwall tube volume too low to provide tube wall support. Meniscus should be 2 to 3 mm below the tube top. Refer to the rotor manual for tube volumes. • Moisture between the tube and the cavity or bucket can cause the tube to float and collapse. Ensure that tubes and tube cavities or buckets are dry before inserting the tubes. • Reagent used that attacks the tube material. Refer to APPENDIX A for chemical compatibilities of tube material and chemicals. • Tubes run above their rated speed. Refer to the applicable rotor manual for maximum speeds.

Chemical Resistances for Beckman Coulter Centrifugation Products



List of Chemical Resistances

Appendix A is replicated in the separate pdf document,
Chemical Resistances (IN-175)

The Use of Cesium Chloride Curves

Introduction

This Appendix describes how to determine a maximum rotor speed and the final band positions of particles when performing isopycnic separations using cesium chloride gradients. The examples shown here are for the MLN-80 rotor only. Similar data and examples for other rotors appear in the applicable rotor manual shipped with each rotor. Be sure to check the manual for your rotor when calculating run speeds and banding positions.

Rotor speed controls the slope (dr/dr) of a CsCl equilibrium gradient. When planning a separation, gradients should be selected so that the density range from the top to the bottom of the gradient is sufficient to encompass the buoyant densities of particles to be separated. However, speeds must often be limited to avoid precipitation of CsCl at the bottom of the gradient. The density of crystallized CsCl (4 g/mL) produces stresses far in excess of the design limits of most rotors. Also, precipitation will alter the density distribution of the gradient, and the position of sample bands.

The square-root reduction formula—used to determine maximum rotor speeds when centrifuging dense solutions in plastic tubes—does not always guard against CsCl precipitation.

$$\text{reduced maximum speed} = (\text{rated speed}) \sqrt{\frac{1.7 \text{ g.mL}}{\rho}} \quad (\text{B-1})$$

where ρ is the density of the tube contents. This speed reduction will protect the rotor from excessive stresses due to the added tube load. *Note, however, that the use of this formula may still produce maximum speed figures that are higher than the limitations imposed by the use of certain tubes or adapters.* In such cases, use the lower of the two figures. The square-root reduction becomes the limiting factor only at relatively high densities and speeds.

Speed and density combinations that intersect on or below the solid curves in Figure B-1 ensure that CsCl will not precipitate in the MLN-80 rotor. Curves are provided at two temperatures: 20°C (black lines) and 4°C (gray lines). Note from [Figure B.1](#) that for a given CsCl density, faster rotor speeds can be used as the fill volume in the tube decreases from full to one-quarter filled. Also, for a given rotor speed, the maximum CsCl density that can be safely centrifuged at that speed and temperature increases as the fill volume decreases.

The curves in [Figure B.2](#) show gradient profiles *at equilibrium*. Each curve was generated for the specific rotor speed shown using the maximum CsCl density (from [Figure B.1](#)) that avoids precipitation at that speed and temperature.* The three-quarter-, one-half-, and one-quarter-filled lines show gradients produced in partially filled tubes. [Figure B.2](#) can be used to approximate

banding positions of sample particles. In general, lower speeds generate gradients with shallow slopes; bands will be farther apart. Higher speeds generate gradients with steep slopes where bands will be closer together. Gradient curves not shown can be interpolated.

NOTE The curves in Figures B-1 and B-2 are for solutions of CsCl salt only. If other salts are present in significant concentrations, the overall CsCl concentration or the rotor speed must be reduced.

Typical Examples for Determining CsCl Run Parameters

Example A: Knowing homogeneous CsCl solution density (1.63 g/mL) and approximate particle buoyant densities (1.70 and 1.65 g/mL), where will particles band?

- 1 In [Figure B.1](#), find the curve that corresponds to the required run temperature (20°C) and fill volume (full).
 - The maximum allowable rotor speed is determined from the point where this curve intersects the homogeneous CsCl density (70,000 rpm).
- 2 In [Figure B.2](#), sketch in a horizontal line corresponding to each particle's buoyant density.
- 3 Mark the point in the figure where each particle density intersects the curve corresponding to the selected run speed and temperature.
- 4 Particles will band at these locations across the tube diameter at equilibrium during centrifugation.

In this example, particles will band about 44.3 and 46.6 mm from the axis of rotation, about 2.3 mm of centerband-to-centerband separation at the rotor's 9-degree tube angle. When the tube is held upright,

* Gradients in Figure B-2 result from homogeneous CsCl solutions, but can be more rapidly generated from step or linear gradients, as long as the total amount of CsCl in solution is equal to the amount in the homogeneous solution from the curves in Figure B-1.

there will be about 2.4 mm of centerband-to-centerband separation. This interband distance, d_{up} , can be calculated from the formula:

$$d_{up} = \frac{d_{\theta}}{\cos\theta} \quad (B-2)$$

where d_{θ} is the interband distance when the tube is held at an angle, θ , in the rotor.

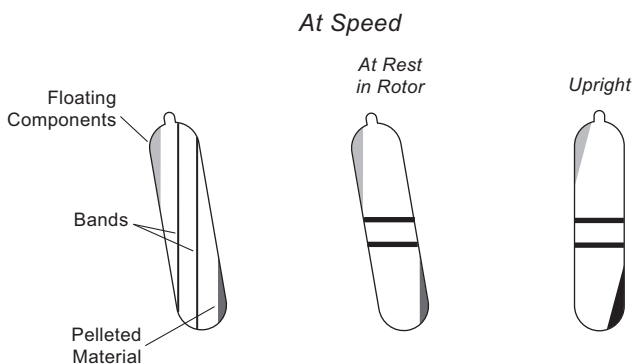

Example B: Knowing particle buoyant densities (for example, 1.59 and 1.54 g/mL), how do you achieve good separation?

1. In [Figure B.2](#), sketch in a horizontal line corresponding to each particle's buoyant density.
2. Select the curve at the desired temperature (4°C) that gives the best particle separation.
3. Note the run speed along the selected curve (60 000 rpm).
4. From [Figure B.1](#), select the maximum homogeneous CsCl density (in this case, 1.63 g/mL) that corresponds to the temperature and run speed established above. These parameters will provide the particle-banding pattern selected in Step 2.

In this example, particles will band at about 37.3 and 41.0 mm from the axis of rotation (about 3.7 mm apart). When the tube is held upright there will be about 3.8 mm of center-of-band to center-of-band separation.

Figure B.1 Precipitation Curves for the MLN-80 Rotor*

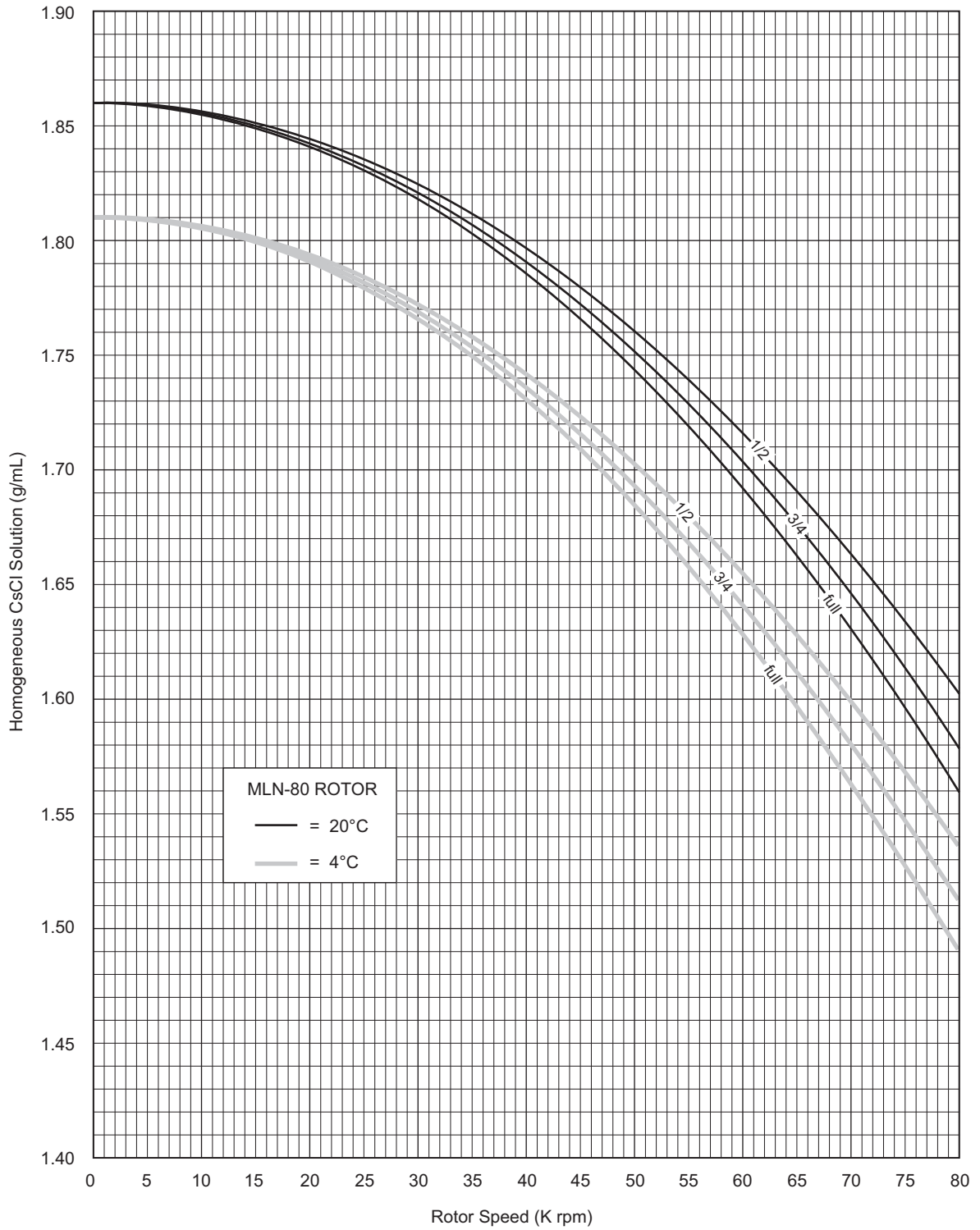

* Using combinations of rotor speeds and homogeneous CsCl solution densities that intersect on or below these curves ensures that CsCl will not precipitate during centrifugation.

Figure B.2 CsCl Gradients at Equilibrium for the MLN-80 Rotor*

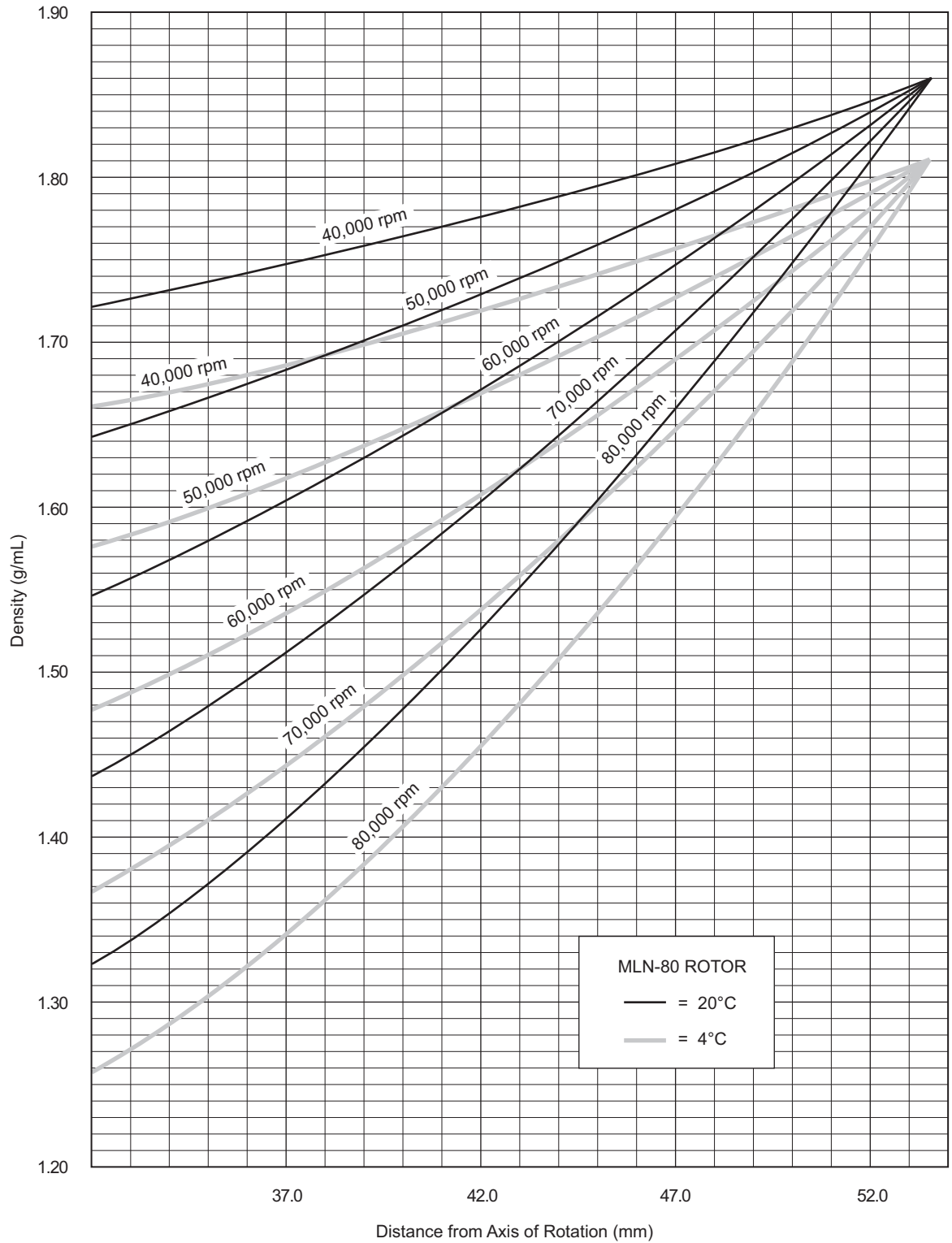

* Centrifugation of homogeneous CsCl solutions at the maximum allowable speeds (from Figure B-1) results in gradients presented here.

The Use of Cesium Chloride Curves

Typical Examples for Determining CsCl Run Parameters

Gradient Materials

Introduction

This Appendix contains reference information on commonly used gradient materials. General instructions for filling and sealing tubes, including gradient preparation, are contained in [CHAPTER 3](#).

Gradient material selection depends on a number of factors, including the type of separation to be performed. Sucrose is used for rate zonal and isopycnic separations, and cesium chloride is often used for isopycnic separations. The basic requirement is that the gradient permit the type of separation. Additional considerations in selecting a gradient material include the following.

- Its density range should be sufficient to permit separation of the particles of interest by the chosen density gradient technique, without overstressing the rotor.
- It should not affect the biological activity of the sample.
- It should be neither hyperosmotic or hypoosmotic when the sample is composed of sensitive organelles.
- It should not interfere with the assay technique.
- It should be removable from the purified product.
- It should not absorb in the ultraviolet or visible range.
- It should be inexpensive and readily available; more expensive materials should be recoverable for reuse.
- It should be sterilizable.
- It should not be corrosive to the rotor.
- It should not be flammable or toxic to the extent that its aerosols could be hazardous.

The following charts are provided as a reference for information on commonly used gradient materials.

Table C.1 Commonly Used Gradient Materials with Their Solvents

Materials	Solvent	Maximum Density at 20°C
Sucrose (66%)	H ₂ O	1.32
Sucrose (65%)	D ₂ O	1.37
Silica sols	H ₂ O	1.30
Diodon	H ₂ O	1.37
Glycerol	H ₂ O	1.26
Cesium chloride	H ₂ O	1.91
	D ₂ O	1.98
Cesium formate	H ₂ O	2.10
Cesium acetate	H ₂ O	2.00
Rubidium chloride	H ₂ O	1.49
Rubidium formate	H ₂ O	1.85
Rubidium bromide	H ₂ O	1.63
Potassium acetate	H ₂ O	1.41
potassium formate	H ₂ O	1.57
	D ₂ O	1.63
Sodium formate	H ₂ O	1.32
	H ₂ O	1.40
Lithium bromide	D ₂ O	1.83
	H ₂ O	
Lithium chloride	D ₂ O	1.33
Albumin	H ₂ O	1.35
Sorbitol	H ₂ O	1.39
Ficoll	H ₂ O	1.17
Metrizamide	H ₂ O	1.46

Table C.2 Density, Refractive Index, and Concentration Data—Cesium Chloride at 25°C, Molecular Weight = 168.37^a

Density (g/cm ³) ^b	Refractive Index, η_D	% by Weight	mg/mL of Solution ^c	Molarity	Density (g/cm ³) ^b	Refractive Index, η_D	% by Weight	mg/mL of Solution ^c	Molarity
1.0047	1.3333	1	10.0	0.056	1.336	1.3657	34	454.2	2.698
1.0125	1.3340	2	20.2	0.119	1.3496	1.3670	35	472.4	2.806
1.0204	1.3348	3	30.6	0.182	1.363	1.3683	36	490.7	2.914
1.0284	1.3356	4	41.1	0.244	1.377	1.3696	37	509.5	3.026
1.0365	1.3364	5	51.8	0.308	1.391	1.3709	38	528.6	3.140
1.0447	1.3372	6	62.8	0.373	1.406	1.3722	39	548.3	3.257
1.0531	1.3380	7	73.7	0.438	1.4196	1.3735	40	567.8	3.372
1.0615	1.3388	8	84.9	0.504	1.435	1.3750	41	588.4	3.495
1.0700	1.3397	9	96.3	0.572	1.450	1.3764	42	609.0	3.617
1.0788	1.3405	10	107.9	0.641	1.465	1.3778	43	630.0	3.742
1.0877	1.3414	11	119.6	0.710	1.481	1.3792	44	651.6	3.870
1.0967	1.3423	12	131.6	0.782	1.4969	1.3807	45	673.6	4.001
1.1059	1.3432	13	143.8	0.854	1.513	1.3822	46	696.0	4.134
1.1151	1.3441	14	156.1	0.927	1.529	1.3837	47	718.6	4.268
1.1245	1.3450	15	168.7	1.002	1.546	1.3852	48	742.1	4.408
1.1340	1.3459	16	181.4	1.077	1.564	1.3868	49	766.4	4.552
1.1437	1.3468	17	194.4	1.155	1.5825	1.3885	50	791.3	4.700
1.1536	1.3478	18	207.6	1.233	1.601	1.3903	51	816.5	4.849
1.1637	1.3488	19	221.1	1.313	1.619	1.3920	52	841.9	5.000
1.1739	1.3498	20	234.8	1.395	1.638	1.3937	53	868.1	5.156
1.1843	1.3508	21	248.7	1.477	1.658	1.3955	54	859.3	5.317
1.1948	1.3518	22	262.9	1.561	1.6778	1.3973	55	922.8	5.481
1.2055	1.3529	23	277.3	1.647	1.699	1.3992	56	951.4	5.651
1.2164	1.3539	24	291.9	1.734	1.720	1.4012	57	980.4	5.823
1.2275	1.3550	25	306.9	1.823	1.741	1.4032	58	1009.8	5.998
1.2387	1.3561	26	322.1	1.913	1.763	1.4052	59	1040.2	6.178
1.2502	1.3572	27	337.6	2.005	1.7846	1.4072	60	1070.8	6.360
1.2619	1.3584	28	353.3	2.098	1.808	1.4093	61	1102.9	6.550
1.2738	1.3596	29	369.4	2.194	1.831	1.4115	62	1135.8	6.746
1.2858	1.3607	30	385.7	2.291	1.856	1.4137	63	1167.3	6.945
1.298	1.3619	31	402.4	2.390	1.880	1.4160	64	1203.2	7.146
1.311	1.3631	32	419.5	2.492	1.9052	1.4183	65	1238.4	7.355
1.324	1.3644	33	436.9	2.595					

a. Density data are from International Critical Tables.

b. Computed from the relationship $\rho^{25} = 10.2402 \eta_D^{25} - 12.6483$ for densities between 1.00 and 1.37, and $\rho^{25} = 10.8601 \eta_D^{25} - 13.4974$ for densities above 1.37 (Bruner and Vinograd, 1965).

c. Divide by 10.0 to obtain % w/v.

Table C.3 Density, Refractive Index, and Concentration Data—Sucrose at 20°C, Molecular Weight = 342.3^a

Density (g/cm ³)	Refractive Index, η_D	% by Weight	mg/mL of Solution ^b	Molarity	Density (g/cm ³)	Refractive Index, η_D	% by Weight	mg/mL of Solution ^b	Molarity
0.9982	1.3330	0			1.1463	1.3883	34	389.7	1.138
1.0021	1.3344	1	10.0	0.029	1.1513	1.3902	35	403.0	1.177
1.0060	1.3359	2	20.1	0.059	1.1562	1.3920	36	416.2	1.216
1.0099	1.3374	3	30.3	0.089	1.1612	1.3939	37	429.6	1.255
1.0139	1.3388	4	40.6	0.119	1.1663	1.3958	38	443.2	1.295
1.0179	1.3403	5	50.9	0.149	1.1713	1.3978	39	456.8	1.334
1.0219	1.3418	6	61.3	0.179	1.1764	1.3997	40	470.6	1.375
1.0259	1.3433	7	71.8	0.210	1.1816	1.4016	41	484.5	1.415
1.0299	1.3448	8	82.4	0.211	1.1868	1.4036	42	498.5	1.456
1.0340	1.3464	9	93.1	0.272	1.1920	1.4056	43	512.6	1.498
1.0381	1.3479	10	103.8	0.303	1.1972	1.4076	44	526.8	1.539
1.0423	1.3494	11	114.7	0.335	1.2025	1.4096	45	541.1	1.581
1.0465	1.3510	12	125.6	0.367	1.2079	1.4117	46	555.6	1.623
1.0507	1.3526	13	136.6	0.399	1.2132	1.4137	47	570.2	1.666
1.0549	1.3541	14	147.7	0.431	1.2186	1.4158	48	584.9	1.709
1.0592	1.3557	15	158.9	0.464	1.2241	1.4179	49	599.8	1.752
1.0635	1.3573	16	170.2	0.497	1.2296	1.4200	50	614.8	1.796
1.0678	1.3590	17	181.5	0.530	1.2351	1.4221	51	629.9	1.840
1.0721	1.3606	18	193.0	0.564	1.2406	1.4242	52	645.1	1.885
1.0765	1.3622	19	204.5	0.597	1.2462	1.4264	53	660.5	1.930
1.0810	1.3639	20	216.2	0.632	1.2519	1.4285	54	676.0	1.975
1.0854	1.3655	21	227.9	0.666	1.2575	1.5307	55	691.6	2.020
1.0899	1.3672	22	239.8	0.701	1.2632	1.4329	56	707.4	2.067
1.0944	1.3689	23	251.7	0.735	1.2690	1.4351	57	723.3	2.113
1.0990	1.3706	24	263.8	0.771	1.2748	1.4373	58	739.4	2.160
1.1036	1.3723	25	275.9	0.806	1.2806	1.4396	59	755.6	2.207
1.1082	1.3740	26	288.1	0.842	1.2865	1.4418	60	771.9	2.255
1.1128	1.3758	27	300.5	0.878	1.2924	1.4441	62	788.3	2.303
1.1175	1.3775	28	312.9	0.914	1.2983	1.4464	62	804.9	2.351
1.1222	1.3793	29	325.4	0.951	1.3043	1.4486	63	821.7	2.401
1.1270	1.3811	30	338.1	0.988	1.3103	1.4509	64	838.6	2.450
1.1318	1.3829	31	350.9	1.025	1.3163	1.4532	65	855.6	2.500
1.1366	1.3847	32	363.7	1.063	1.3224	1.4558	66	872.8	2.550
1.1415	1.3865	33	376.7	1.100	1.3286	1.4581	67	890.2	2.864

a. Density and refractive index data are from the International Critical Tables.

b. Divide by 10.0 to obtain % w/v.

Table C.4 Density Conversion for Cesium and Rubidium Salts at 20°C

% w/w	CsCl	CsBr	CsI	Cs ₂ SO ₄	CsNO ₃	RbCl	RbBr	RbI	Rb ₂ SO ₄	RbNO ₃
1	1.00593	1.00612	1.00608	1.0061	1.00566	1.00561	1.00593	1.00591	1.0066	1.0053
2	1.01374	1.01412	1.01402	1.0144	1.01319	1.01307	1.01372	1.01370	1.0150	1.0125
4	1.02969	1.03048	1.03029	1.0316	1.02859	1.02825	1.02965	1.02963	1.0322	1.0272
6	1.04609	1.04734	1.04707	1.0494	1.04443	1.04379	1.04604	1.04604	1.0499	1.0422
8	1.06297	1.06472	1.06438	1.0676	1.06072	1.05917	1.06291	1.06296	1.0680	1.0575
10	1.08036	1.08265	1.08225	1.0870	1.07745	1.07604	1.08028	1.08041	1.0864	1.0731
12	1.09828	1.10116	1.10071	1.1071	1.09463	1.09281	1.09817	1.09842	1.1052	1.0892
14	1.11676	1.12029	1.11979	1.1275	1.11227	1.11004	1.11661	1.11701	1.1246	1.1057
16	1.13582	1.14007	1.13953	1.1484		1.12775	1.13563	1.13621	1.1446	1.1227
18	1.15549	1.16053	1.15996	1.1696		1.14596	1.15526	1.15605	1.1652	1.1401
20	1.17580	1.18107	1.18112	1.1913		1.16469	1.17554	1.17657	1.1864	1.1580
22	1.19679	1.20362	1.20305	1.2137		1.18396	1.19650	1.19781	1.2083	1.1763
24	1.21849	1.22634	1.22580	1.2375		1.20379	1.21817	1.21980	1.2309	1.1952
26	1.24093	1.24990	1.24942	1.2643		1.22421	1.24059	1.24257	1.2542	1.2146
28	1.26414	1.27435	1.27395			1.24524	1.26380	1.26616	1.2782	1.2346
30	1.28817	1.29973	1.29944			1.26691	1.28784	1.29061	1.3028	1.2552
35	1.35218	1.36764	1.36776			1.32407	1.35191	1.35598	1.3281	1.2764
40	1.42245	1.44275	1.44354			1.38599	1.42233	1.42806		
45	1.49993	1.52626	1.52803			1.45330	1.50010	1.50792		
50	1.58575	1.61970	1.62278			1.52675	1.58639	1.59691		
55	1.68137	1.72492					1.68254	1.69667		
60	1.78859							1.80924		
65	1.90966							1.93722		

References

List of References

Documents referenced below can be obtained by calling Beckman Coulter at 1-800-742-2345 in the United States, or by contacting your local Beckman Coulter office.*

IN-175	<i>Chemical Resistances for Beckman Coulter Centrifugation Products</i>
IN-181	<i>How to Use Quick Seal Tubes with the Beckman Cordless Tube Topper</i>
IN-189	<i>Using OptiSeal Tubes</i>
IN-192	<i>Use and Care of Centrifuge Tubes and Bottles</i>
IN-197	<i>Rotor Safety (Multi-lingual)</i>
L5-TB-081	<i>Beckman Fraction Recovery Systems</i>
TL-TB-008	<i>Instructions for Using the Beckman Coulter CentriTube Slicer</i>

Documents referenced below are available upon request from:

Beckman Coulter, Inc.
Marketing Communications
250 S. Kraemer Blvd.
Brea, CA 92821 U.S.A.

or are available at www.beckmancoulter.com

A-1790	<i>Plasmid Separations in NVT Near-Vertical Tube Rotors</i>
A-1804	<i>Rapid Mitochondrial DNA Isolation Using Beckman Type 100 Ti Rotor</i>
A-1846	<i>Selected Run Conditions for Optimizing the Separation of RNA Using Centrifugation in Either a Preparative Floor or Tabletop Instrument</i>
A-1850	<i>A Rapid Method for Ribosome Preparation: Part 1 – Using High-Capacity Fixed-Angle MLA-80 Rotor in an Optima MAX Tabletop Ultracentrifuge</i>
A-1851	<i>A Rapid Method for Ribosome Subunit Isolation: Part 2 – Using the High-Capacity Swinging-Bucket MLS-50 Rotor in an Optima MAX Tabletop Ultracentrifuge</i>
BA99-60495	<i>Rotor Safety Guide: Warranty and Care</i>
BR-10656	<i>Optima MAX-XP Benchtop Ultracentrifuge</i>

* For detailed information on a rotor, see the applicable individual rotor manual.

References

List of References

- BR-8101 *Ultracentrifuge Rotors, Tubes & Accessories Catalog*
- BR-8108 *Optima Series*
- BR-8240 *Optima MAX System*
- DS-468 *Techniques of Preparative, Zonal, and Continuous Flow Ultracentrifugation*
- DS-514 *Ultracentrifuge Methods for Lipoprotein Research*
- DS-528 *Use of the ω^2t Integrator*
- DS-640 *Formation of Linear Sucrose Gradients for the TLS-55 Rotor*
- DS-641 *A Microscale Method for Isolating Plasmid DNA in the TL-100 Tabletop Ultracentrifuge*
- DS-642 *A Rapid Method for Isolating Plasmid DNA in the TL-100 Tabletop Ultracentrifuge*
- DS-644 *Rate Zonal Separation on Sucrose Density Gradients in the TLS-55 Rotor*
- DS-670 *Rapid Preparation of Synaptic Membranes From Ultrasmall Samples*
- DS-694 *30-Minute 2-Step Purification of Plasma Membranes from Cultured Cells*
- DS-709 *g-Max System: Short Pathlengths in High Force Fields*
- DS-728 *Optimizing Centrifugal Separations: Sample Loading*
- DS-733 *Preparation DNA from Bacteriophage Lambda Isolated in the TL-100 Tabletop Ultracentrifuge*
- DS-803 *TLA-100.4 Rotor; New Rotor Increases Sample Volume*
- DS-814 *Plasmid Separations in Tabletop Ultracentrifuges Using Fixed-Angle Rotors*
- DS-820 *Determination of Molecular Weights by Sedimentation Equilibrium*
- DS-835 *Short Column Sedimentation Equilibrium Analysis for Rapid Characterization of Macromolecules in Solution*
- DS-850 *Isolation of Human VLDL, LDL, HDL and Two HDL Subclasses in the TL-100 Tabletop Centrifuge Using the TLA-100.4 Rotor*
- DS-888 *Plasmid Separations in Just 1 1/2 Hours With the New TLN-120 Rotor*
- DS-10091 *MLA-55 Rotor for Optima MAX Series Micro Ultracentrifuges*
- DS-9271 *Using k Factor to Compare Rotor Efficiency*
- SB-778 *Ultracentrifuge Rotors Brochure*
- SR-171 *Rapid Isolation of Both RNA & DNA from Cultured Cell*
- SR-182 *Purity, Antigenicity, and Immunogenicity*
- T-1734 *Separation of Lipoproteins from Human Plasma with the TLN-100 Near-Vertical Tube Rotor*
- T-1784 *Separation of Plasma Lipoproteins with the TLN-100 Near-Vertical Tube Rotor*

Glossary

Angular velocity, ω — Rate of rotation, measured in radians per second

$$\omega = \frac{2\pi \text{ rpm}}{60}$$

or

$$\omega = 0.10472 \text{ rpm}$$

Anodized coating — A thin, hard layer of aluminum oxide formed electrochemically on aluminum rotor and/or accessory surfaces as a protective coating for corrosion resistance

Autoclaving — Sterilization by heat (dry or steam)

Buoyant density — The density of a particle in a specified liquid medium

Buna N — Black nitrile rubber used for O-rings and gaskets in rotor assemblies; should be used at temperatures between -34 and 121°C (-30 and 250°F)

Centrifugal effect — Accumulated value of:

$$\int_{t_1}^{t_2} \omega^2 dt$$

where t is time and w is angular velocity

Centrifugal force — In a centrifugal field, the force which causes a particle to move away from the center of rotation

Clearing factor k — Calculated for all Beckman Coulter high-speed rotors as a measure of the rotor's relative pelleting efficiency:

$$k = \frac{\ln(r_{\max}/r_{\min})}{\omega^2} \times \frac{10^{13}}{3600}$$

or

$$k = \frac{253303 \times \ln(r_{\max}/r_{\min})}{(\text{RPM} / 1000)^2}$$

Clearing time, t — $t = k/s$, where t is time in hours, k is the clearing factor of the rotor, and s is the sedimentation coefficient in Svedberg units (S)

CsCl — Cesium chloride; a high-density salt used in solution in isopycnic separations to separate particles based on their density

CsSO — Cesium sulfate; a salt, similar to CsCl, that will form its own gradient in solution

Delrin — Thermoplastic material (acetal homopolymer) used for most tube adapters (Delrin is a registered trademark of E.I. Du Pont de Nemours & Company.)

Density — Mass per unit volume

Density separation — A centrifugal separation process based on differences in particle densities

Differential separation — A centrifugal separation process based on differences in particle sizes

EPDM — Ethylene propylene rubber used for O-rings and pad adapters; should be used at temperatures between -57 and 120°C (-70 and 250°F)

Ethidium bromide — A fluorescent intercalating orange dye used commonly in the separation of DNA and in gel electrophoresis

Fixed-angle rotor — A rotor in which the tubes are held at an angle (usually 20 to 45 degrees) from the axis of rotation

g-Max — A system of centrifugation using a combination of short Quick-Seal tubes and floating spacers, designed to reduce volumes while maximizing separation efficiency

HDPE — High density polyethylene used for adapters

Isopycnic — A method of particle separation or isolation based on particle buoyant density; particles are centrifuged until they reach a point in the gradient where the density of the particle is the same as the density of the gradient at that point

konical tubes — Thin-walled, polypropylene tubes featuring a conical tip to optimize pelleting separations; the conical tip concentrates the pellet in the narrow base of the tube. Available in both open-top and Quick-Seal bell-top designs.

Maximum volume — The maximum volume at which a tube should be filled for centrifugation (sometimes referred to as maximum fill volume or nominal fill volume)

Meniscus — The curved upper surface of a liquid column that is concave when the container walls are wetted by the liquid and convex when they are not

Near-vertical tube rotor — A rotor in which the tubes are held at a slight angle (usually 7 to 10 degrees)

Neoprene — Black synthetic elastomer used for O-rings in some tube caps and bottle cap assemblies; should be used at temperatures between -54 and 121°C (-65 and 250°F)

Noryl — Modified thermoplastic polyphenylene oxide (PPO) used for floating spacers (part of the g-Max system) and some polycarbonate bottle caps (Noryl is a registered trademark of GE Plastics.)

OptiSeal tubes — Capless tubes with sealing plugs inserted in the tube stems; during centrifugation, the combination of g force and hydrostatic pressure seals the tube

Overspeed disk — An adhesive disk, with alternating reflecting and nonreflecting sectors, attached to the bottom of rotors as part of the photoelectric overspeed protection system; the number of sectors on the disk is a function of the rotor's maximum allowable speed

Pelleting — A centrifugal separation process in which particles in a sample sediment to the bottom of the tube (differential separation); differential pelleting separates particles of different sizes by successive centrifugation steps of progressively higher g force and/or longer run duration

PET — polyethylene terephthalate used in some adapters

Quick-Seal tubes — bell-top or dome-top thinwall tubes that are heat-sealed and require no caps

Radel — Polyphenylsulfone (PPS) used in plugs, cap closures, cannisters and other accessories

Rate zonal — A method of particle separation, based on differential rate of sedimentation, using a preformed gradient with the sample layered as a zone on top of the gradient

RCF — Relative centrifugal field; the ratio of the centrifugal acceleration at a specified radius and speed ($r\omega^2$) to the standard acceleration of gravity (g) according to the following equation:

$$\text{RCF} = \frac{r\omega^2}{g}$$

where r is the radius in millimeters, ω is the angular velocity in radians per second ($2\pi \text{ RPM}/60$), and g is the standard acceleration of gravity (9807 mm/s^2). Thus the relationship between RCF and RPM is:

$$\text{RCF} = 1.12r \left(\frac{\text{RPM}}{1000} \right)^2$$

r_{max} — (Maximum radius) the position of the liquid in the tube at the maximum distance from the axis of rotation when the rotor is at speed

r_{min} — (Minimum radius) the position of the liquid in the tube at the minimum distance from the axis of rotation when the rotor is at speed

Sedimentation — The settling out of particles from a suspension in the earth's field of gravity; in the centrifuge this process is accelerated and the particles move away from the axis of rotation

Sedimentation coefficient, s — Sedimentation velocity per unit of centrifugal force:

$$s = \frac{dr}{dt} \times \frac{1}{\omega^2 r}$$

Silicone rubber — A large group of silicone elastomers used in various accessories; should be used at temperatures between -59 and 232°C (-75 and 450°F)

Solution 555 — Beckman Coulter concentrated rotor cleaning solution; recommended because it is a mild solution that has been tested and found effective and safe for Beckman Coulter rotors and accessories

Spinkote — Beckman Coulter lubricant for metal-to-metal contacts

Sucrose — A sugar (not a self-forming gradient) used in rate zonal separations; generally used in separating RNA, subcellular organelles, and cell membranes

Supernatant — The liquid above the sedimented material following centrifugation

Svedberg unit, S — A unit of sedimentation velocity:

$$1 S = 10^{-13} \text{ seconds}$$

Swinging-bucket rotor — A rotor in which the tubes or bottles are carried in buckets, microtiter plate carriers, or racks that swing up to the horizontal position during centrifugation (sometimes referred to as a horizontal or swing-out rotor)

Ultem — Polyetherimide (PEI)—used in adapters, covers, and spacers; should be used at temperatures between -29 and 204°C (-20 and 400°C) (Ultem is a registered trademark of GE Plastics.)

Vertical-tube rotor — A rotor in which the tubes or bottles are held parallel to the axis of rotation

Viton — Fluorocarbon elastomer used in high-temperature applications (Viton is a registered trademark of E.I. Du Pont de Nemours & Company.)

Wettable — Tube or bottle material that water or other aqueous solution will adhere to; the more wettable a tube or bottle material is, the more biological material, DNA, protein, cells, and so forth, will adhere to the walls

Ultracentrifuge Rotor Warranty

All Beckman Coulter ultracentrifuge Fixed-Angle, Vertical-Tube, Near-Vertical Tube, Swinging-Bucket, and Airfuge rotors are warranted against defects in materials or workmanship for the time periods indicated below, subject to the Warranty Conditions stated below.

Preparative Ultracentrifuge Rotors	5 years, No Proration
Analytical Ultracentrifuge Rotors	5 years, No Proration
ML and TL Series Ultracentrifuge Rotors	5 years, No Proration
Airfuge Ultracentrifuge Rotors	1 year, No Proration

For Zonal, Continuous Flow, Component Test, and Rock Core ultracentrifuge rotors, see separate warranty.

Warranty Conditions (as applicable)

1. This warranty is valid for the time periods indicated above from the date of shipment to the original Buyer by Beckman Coulter or an authorized Beckman Coulter representative.
2. This warranty extends only to the original Buyer and may not be assigned or extended to a third person without written consent of Beckman Coulter.
3. This warranty covers the Beckman Coulter Centrifuge Systems only (including but not limited to the centrifuge, rotor, and accessories) and Beckman Coulter shall not be liable for damage to or loss of the user's sample, non-Beckman Coulter tubes, adapters, or other rotor contents.
4. This warranty is void if the Beckman Coulter Centrifuge System is determined by Beckman Coulter to have been operated or maintained in a manner contrary to the instructions in the operator's manual(s) for the Beckman Coulter Centrifuge System components in use. This includes, but is not limited to operator misuse, abuse, or negligence regarding indicated maintenance procedures; centrifuge and rotor classification requirements; proper speed reduction for the high density of certain fluids, tubes, and tube caps; speed reduction for precipitating gradient materials; and speed reduction for high-temperature operation.
5. Rotor bucket sets purchased concurrently with or subsequent to the purchase of a Swinging Bucket Rotor are warranted only for a term co-extensive with that of the rotor for which the bucket sets are purchased.
6. This warranty does not cover the failure of a Beckman Coulter rotor in a centrifuge not of Beckman Coulter manufacture, or if the rotor is used in a Beckman Coulter centrifuge that has been modified without the written permission of Beckman Coulter, or, if the rotor is used with carriers, buckets, belts, or other devices not of Beckman Coulter manufacture.
7. Rotor parts subject to wear, including, but not limited to, rotor O-rings, VTi, NVT, TLV, MLN, and TLN rotor tube cavity plugs and gaskets, tubing, tools, optical overspeed disks, bearings, seals, and lubrication are excluded from this warranty and should be frequently inspected and replaced if they become worn or damaged.
8. Keeping a rotor log is not mandatory, but may be desirable for maintenance of good laboratory practices.

Repair and Replacement Policies

1. If a Beckman Coulter rotor is determined by Beckman Coulter to be defective, Beckman Coulter will repair or replace it, subject to the Warranty Conditions. A replacement rotor will be warranted for the time remaining on the original rotor's warranty.
2. If a Beckman Coulter centrifuge is damaged due to a failure of a rotor covered by this warranty, Beckman Coulter will supply free of charge (i) all centrifuge parts required for repair (except the drive unit, which will be replaced at the then current price less a credit determined by the total number of revolutions or years completed, provided that such a unit was manufactured or rebuilt by

Beckman Coulter), and (ii) if the centrifuge is currently covered by a Beckman Coulter warranty or Full Service Agreement, all labor necessary for repair of the centrifuge.

3. If a Beckman Coulter rotor covered by this warranty is damaged due to a malfunction of a Beckman Coulter ultracentrifuge covered by an Ultracentrifuge System Service Agreement, Beckman Coulter will repair or replace the rotor free of charge.
4. If a Beckman Coulter rotor covered by this warranty is damaged due to a failure of a Beckman Coulter tube, bottle, tube cap, spacer, or adapter, covered under the Conditions of this Warranty, Beckman Coulter will repair or replace the rotor and repair the instrument as per the conditions in policy point (2) above, and the replacement policy.
5. Damage to a Beckman Coulter rotor or instrument due to the failure or malfunction of a non-Beckman Coulter tube, bottle, tube cap, spacer, or adapter is not covered under this warranty, although Beckman Coulter will assist in seeking compensation under the manufacturer's warranty.

Disclaimer

IT IS EXPRESSLY AGREED THAT THE ABOVE WARRANTY SHALL BE IN LIEU OF ALL WARRANTIES OF FITNESS AND OF THE WARRANTY OF MERCHANTABILITY AND BECKMAN COULTER, INC. SHALL HAVE NO LIABILITY FOR SPECIAL OR CONSEQUENTIAL DAMAGES OF ANY KIND WHATSOEVER ARISING OUT OF THE MANUFACTURE, USE, SALE, HANDLING, REPAIR, MAINTENANCE, OR REPLACEMENT OF THE PRODUCT.

Factory Rotor Inspection Service

Beckman Coulter, Inc., will provide free mechanical and metallurgical inspection in Indianapolis, Indiana, USA, of any Beckman Coulter rotor at the request of the user. (Shipping charges to Beckman Coulter are the responsibility of the user.) Rotors will be inspected in the user's laboratory if the centrifuge in which they are used is covered by an appropriate Beckman Coulter Service Agreement. Contact your local Beckman Coulter office for details of service coverage or cost.

Before shipping, contact the nearest Beckman Coulter Sales and Service office and request a Returned Goods Authorization (RGA) form and packaging instructions. Please include the complete rotor assembly, with buckets, lid, handle, tube cavity caps, etc. A SIGNED STATEMENT THAT THE ROTOR AND ACCESSORIES ARE NON-RADIOACTIVE, NON-PATHOGENIC, NON-TOXIC, AND OTHERWISE SAFE TO SHIP AND HANDLE IS REQUIRED.

www.beckmancoulter.com

